



CSMIO/IP-S

6-axis CNC controller (step/dir)



HARDWARE VERSION (software supported):
v2 (Mach3)
v2 FP4 (simCNC, Mach3, Mach4)

FIRMWARE VERSION (software supported):
v2.020 - v2.910 (Mach3)
v3 (simCNC, Mach4)



CONTENT

1. General	5
1.1 Signs used in this guide	6
1.2 Content	6
1.3 Standards compliance.....	7
1.4 Specification.....	7
2. Safety.....	8
2.1 Example of direct E-Stop Signal connection.....	9
2.2 Example of E-Stop Signal connection using PILZ module	10
3. Recommendations for mechanical installation.....	11
3.1 Examples of components arrangement in a control cabinet.	11
3.1.1 Block scheme pictorial view.....	11
3.1.2 Control cabinet made by CS-Lab Company.....	12
4. Connectors, controls and electrical installation of the device	13
4.1 Connectors arrangement on the device	13
4.2 STEP/DIR controlling signals connector (CSMIO/IP-S v2)	14
4.2.1 Signals on a Terminal Block connector	15
4.2.2 Example – M542 drive connection	15
4.3 Digital outputs connector (0-15) (CSMIO/IP-S v2)	16
4.3.1 Output circuits construction	17
4.3.2 Signals on a Terminal Block connector	17
4.3.3 Examples – spindle switching signal.....	18
4.4 Digital inputs connector (0-15) (CSMIO/IP-S v2).....	19
4.4.1 Input circuits construction.....	20
4.4.2 Signals on a Terminal Block connector	20
4.4.3 Examples of input signals connection.....	21
4.5 Digital inputs connector (16-31) (CSMIO/IP-S v2).....	23
4.6 Analog inputs/outputs connector	24
4.6.1 Signals on a Terminal Block connector	24
4.6.2 Example – connection and configuration of potentiometers.....	25
4.7 Expansion modules connector	26
4.8 Power connector.....	26
4.9 Communication connector – Ethernet.....	27
4.10 Recommended cables.....	28
4.11 Installation examples	29
4.11.1 Inverter connection using analog output.....	29
4.11.2 Illustrative diagram of XYZ plotter (CSMIO/IP-S v2).....	30



4.11.3	Automatic control of drives power supply (HV)	32
4.12	LED lights meaning	33
4.12.1	Types and location of the LEDs	33
4.12.2	State diodes description - STATx	34
5.	Recommendations and drives selection (motors drives)	35
6.	Precise homing with encoder INDEX signal	37
6.1	Solution no. 1 – Homing on “index” function	37
6.2	Solution no. 2 – Synchronization of HOME signal in servo drives.	38
7.	LAN connection and configuration	40
7.1	Direct connection to PC	40
7.1.1	Windows®XP configuration.	40
7.1.2	Windows® 7 configuration.	41
7.2	Local network with router and DHCP	44
8.	Mach3 software – general information	45
8.1	Recommended PC configuration	47
9.	Software installation	48
9.1	Mach3 installation	48
9.2	Microsoft® .Net installation (older operating systems)	49
9.3	Installation of CSMIO/IP software	49
9.4	Administrator rights in Windows® Vista and Windows® 7	51
10.	Mach3 software configuration	52
10.1	Configuration profile creation	52
10.2	The first run	53
10.3	Configuration of axes used in a machine	55
10.4	Configuration of digital input signals	56
10.5	Configuration of digital output signals	58
10.6	Configuration of spindle and cooling	60
10.6.1	Analog output configuration	60
10.6.2	Problematic PWM Control function	61
10.7	Configuration of resolution, speed and acceleration	62
10.8	Configuration of directions, homing and software limits.	64
10.9	Configuration functions in a plug-in window	65
10.9.1	Axes special functions	65
10.9.2	Spindle configuration	68
10.9.3	Override sources – feed speed and spindle revs corrections source selection	69
10.9.4	Plasma – additional functions for plasma cutters	70
10.9.5	Misc IO – Special functions related to I/O	70
10.9.6	Other plugin functions	71



10.10 Selection of inch/mm units	73
10.11 Some parameters in the General Config window.	73
11. First tests.....	75
11.1 Checking the input signals	75
11.2 Verification of axes scaling and motion directions.....	76
11.3 HOMING and software limit switches test.....	77
11.3.1 First homing	77
11.3.2 SoftLimit switches.....	77
11.4 Test of spindle and cooling.	78
12. Sample treatment step by step.....	79
12.1 Project and G-Code files preparing	79
12.2 Preparing machine and Mach3 software	83
12.3 We begin the treatment	85
13. A few practical notes about Mach3 software and CSMIO/IP-S	87
14. VisualBasic® macros	89
14.1 Automatic tool-length measurement	89
14.1.1 Configuration.....	90
14.2 Automatic tool change macro.....	91
Addition A – Slave axis configuration example	92
Defining axes used in Mach3 software	92
Axis scaling and configuration	92
Activation and choice of <i>slave</i> axis.....	92
LIMIT and HOMING switches	93
Axis direction settings	93
Manual feed test	93
Automatic reading of HOME switches position difference	93
Geometry correction mode activation	93
Addition B – CSMIO/IP-S firmware update	94
How to check current firmware version.....	94
Update application (uploader)	94
Plugin file update	95
Update verification.....	95



1. General

CSMIO/IP-S motion controller was designed for professional customers, who want to equip their machine tool with an efficient, stable and flexible CNC control system for a reasonable price.

Our main goal is to achieve operation stability – hence the PC connection via Ethernet (its physical layer is galvanically isolated and protocols we use ensure reliable and fast transmission even in tough industrial environment). Practically any other interfaces do not provide the continuity and reliability of transmission on such a high level as the ETHERNET. That is why it is currently the worldwide standard for high-speed digital communication.

Another important goal was simplicity of installation. CSMIO/IP-S does not require any external electronics for proper operation. Inputs/outputs signals are inside optically isolated, filtered, protected against short circuit, overheating etc. All signals are adjusted to industry standard 24V. The device is enclosed in a compact cover, mounted on a DIN-rail, what makes that mechanical and electronic installation in a control cabinet takes less time and is even simpler.

CSMIO/IP-S product can work with three different control software: simCNC (by CS-Lab), Mach3 and Mach4 (by ArtSoft Newfangled Solutions). The oldest and the best known is Mach3 software. As it showed up it provided great ability to adapt to specific requirements at low price. This way it became very popular. Mach4 software provides even better flexibility, better stability of work and more features.

Basing on many years of experience with many different types of CNC machines CS-Lab created the simCNC software as an alternative to Mach3 and Mach4. It provides features that many users could not get using other CNC control software. In between the S-curve profile which allows to keep very high axis accelerations without any noticeable knocking in a drive train system. Advanced optimization and precision algorithms help you to achieve unusual dynamics and accuracy of machining. simCNC is professional and on the other hand, simple to use. It provides reliability and maximum efficiency (treatment is fast, dynamic and precise). SimCNC software is still actively developed to be the best solution to replace the very expensive top control systems for CNC machines.

CSMIO/IP-S supports the popular step/direction standard (step/dir) as the drivers control interface. It can control both the stepper motor drives and the most modern servo drives. Frequency of stop signal that reaches to 4MHz (Mach3) or up to 8MHz (simCNC, Mach4) provides maximum advantage of stepper division in stepper motors still reducing resonance and significantly improving performance of propulsion system. It also allows for taking full advantage of encoders with large number of pulses per rotation in servo drives, and the same lets you to achieve such precision and speed, which previously were unavailable in this price sector.



1.1 Signs used in this guide



Potential danger, possible injury risk



Useful information, tips



Warning, failure to comply with these warnings may lead to inappropriate functioning or damage of the device

1.2 Content



The CSMIO/IP-S set includes terminal block adapters for easier wires connection in a control cabinet. More content details below:

1. CNC CSMIO/IP-S Controller
2. 2xDB25 Terminal Block adapter
3. 2xDB25 + 1xDB9 Terminal Block adapter
4. Ethernet connection wire
5. DB25 connection tape (4 pcs.)
6. DB9 connection tape (1 pc.)
7. „Phoenix” 3 pin power plug (1 pc.)
8. CD with electronic version of user guides and firmware (*always check if there is a newer version on www.cs-lab.eu*)

If you can't find any of these parts in your package please contact your supplier.



1.3 Standards compliance

CSMIO/IP-S controllers were designed and made in accordance with national and international standards for industrial control systems based on electronic components:

- Detailed requirements for programmable controllers: working characteristics, shock resistance, safety etc. EN61131-2 (IEC1131-2), CSA 22.2, UL508
- Compliance with European Guidelines (low voltage, level of electromagnetic interference *Electromagnetic Compatibility*), the CE marking.
- Electrical and non-combustible properties of insulation materials: UL 746C, UL 94, etc.
- The Product made in lead-free technology, RoHS compliant.



1.4 Specification

PARAMETER	VALUE
Number of digital inputs	32
Number of digital outputs	16
Number of analog inputs	4
Number of analog outputs	2
Supply voltage	24VDC +/-10%
Power consumption	5W
Maximum voltage on in/out lines	30VDC
Maximum load of an output line	250mA
A voltage range of analog inputs	0-10VDC
Maximal load of analog output	5mA
Axis drives control type	STEP/DIR [RS422]
Maximum frequency of a STEP signal	4MHz
STEP signal duty cycle	50%
PC connection	Ethernet 10/100Mb
Ambient temperature range	0°C to +60°C
Relative humidity	10% do 95% (without condensation)





The STEP outputs signals frequency are in no way limited by the „Kernel speed” settings in Mach3 software. While using the CSMIO/IP-S controller this Mach3 configuration parameter is unused and can be set on any value.



2. Safety

CSMIO/IP-S device is powered by 24V safe voltage. I/O control lines are optically isolated, also PC connection is galvanically isolated. The device does not constitute direct threat to health and life of a user. Designing a complete control system (control cabinet), you should draw attention to several issues, so that the entire system does not pose any hazard during use.

-  Always use NC contacts (Normal Closed) for limit switches and safety switch. Thanks to it - a wiring mistake or i.e. plug-ins disconnection will stop the machine.

-  Pay special attention to an emergency stop circuit. Control system must be designed in such a way that when you press an emergency stop mushroom, controlled machine stops immediately in all axes. You should also take into account the possibility of failure of particular system components such as main controller, or axis drives.
For that you can use a standard safety relay (it's not required, it's an option). The safety switch mushroom, FAULT signals of drives and inverter and eventually other alarm signals – you should connect to input circuits. Output or outputs should be connected to CSMIO/IP-S controller, and defined as emergency stop. Outputs of security module should be also connected to axis drives, inverters, etc. This way we get double protection – if, by inappropriate configuration or CSMIO/IP-S controller failure - the emergency would not work, then information goes to axis drives, which can properly respond to it. It works both sides: if drives would not react, you always have the controller.

-  The CSMIO-IP/S Controller in active state on the input line - defined as E-Stop, blocks the STEP signals within 0.0005 s. It happens autonomously, without Mach3 software and thus the machine stops very fast. The same happens with reaction to signals from limit switches.



2.1 Example of direct E-Stop Signal connection

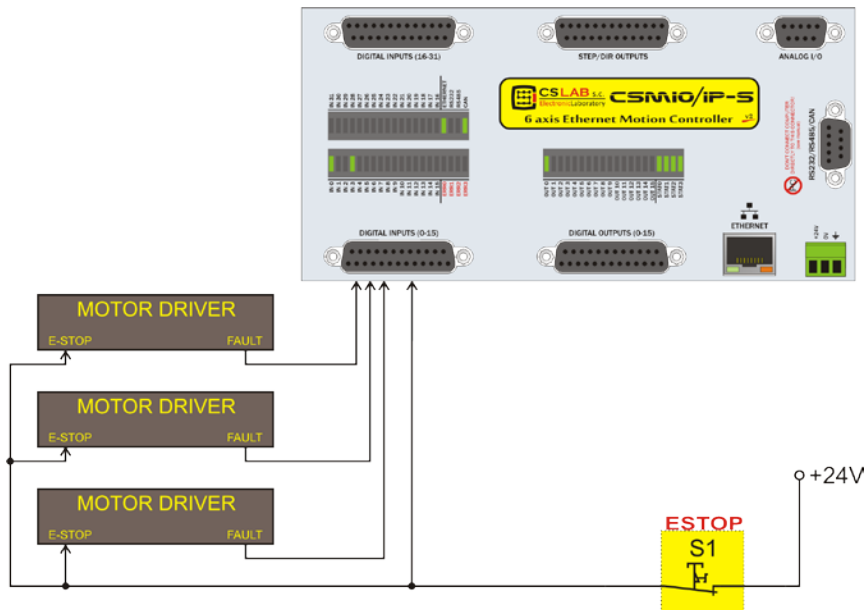

In the example above we used direct emergency signals connection. Such a connection is very easy and at the same time, it ensures satisfying safety level. Of course, the easiest way is to connect the E-Stop only to CSMIO/IP-S but then we lose double protection and it is no longer so safe solution.



As a switch (mushroom) of emergency stop always use special switchers, specially designed for that. They have different construction and you can be actually 100% sure that the circuit will be disconnected after pressing the mushroom. Using common NC contacts is dangerous. It is worth to use contacts from reputable companies. They are a little bit more expensive but their quality is much, better.

2.2 Example of E-Stop Signal connection using PILZ module

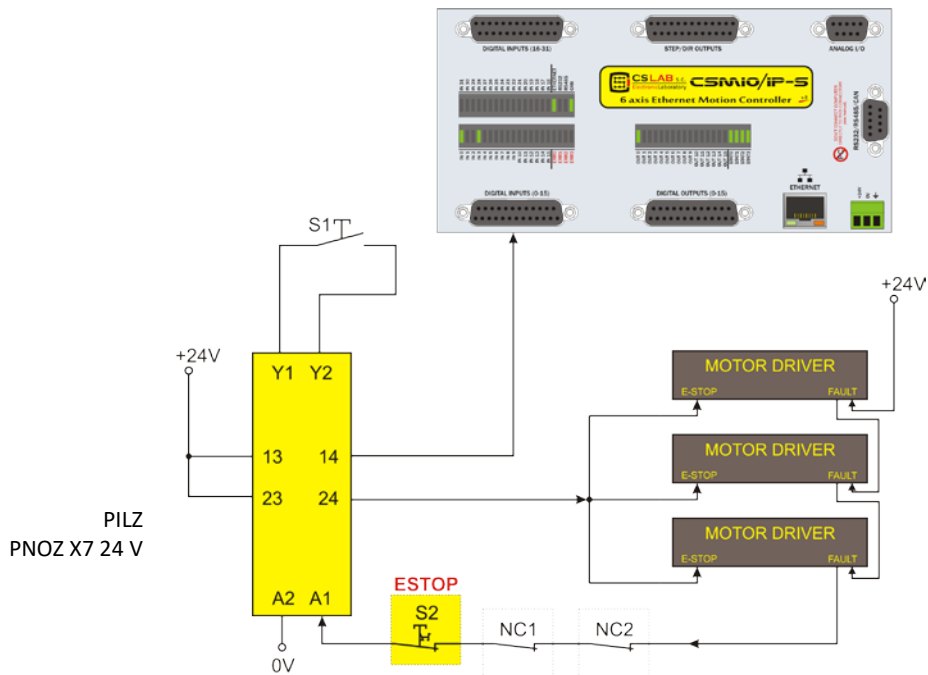

Above you can see an example of E-Stop signal connection to the CSMIO/IP-S controller and to the axis drives, using Pilz company safety relay (PNOZ X7 24V symbol). S1 is a reset button (switching on the safety relay), S2 is the emergency stop. The safety relay is an option, it's not required.

This module has one input, and due to it, all the alarm sources are connected to this input (A1). In addition to the mentioned emergency stop (S2) there are NC contacts - NC1 and NC2, which may be, e.g. opening sensors for a cover and a control cabinet. Moreover, there are drives FAULT signals connected in series. Two outputs of the safety relay were used as the E-Stop signal for the CSMIO/IP-S controller and axis drives.

This combination assures that machine stops in case of failure on any axis (FAULT signals of the drives), by pressing the emergency stop mushroom and opening the cabinet or the cover. Separation of output channels of the safety relay gives double protection to a system and significantly increases reliability of the entire system.



3. Recommendations for mechanical installation

CSMIO/IP-S controller and DB->Terminal block connectors were designed to be installed on a standard DIN-rail. It is the quickest and the best way of installation.

The Controller uses a small amount of electricity and creates a negligible amount of heat. Aluminum housing provides adequate cooling for electronics inside, even if an ambient temperature reaches 40°C.

As for the controller, there are no special precautions for ventilation and minimum distances. However, usually, next to the controller in a control cabinet, there are also inverters, power supplies, motor drives - these components emit a lot of heat, so you should always remember about their proper location and proper ventilation of the cabinet.

3.1 Examples of components arrangement in a control cabinet.

3.1.1 Block scheme pictorial view

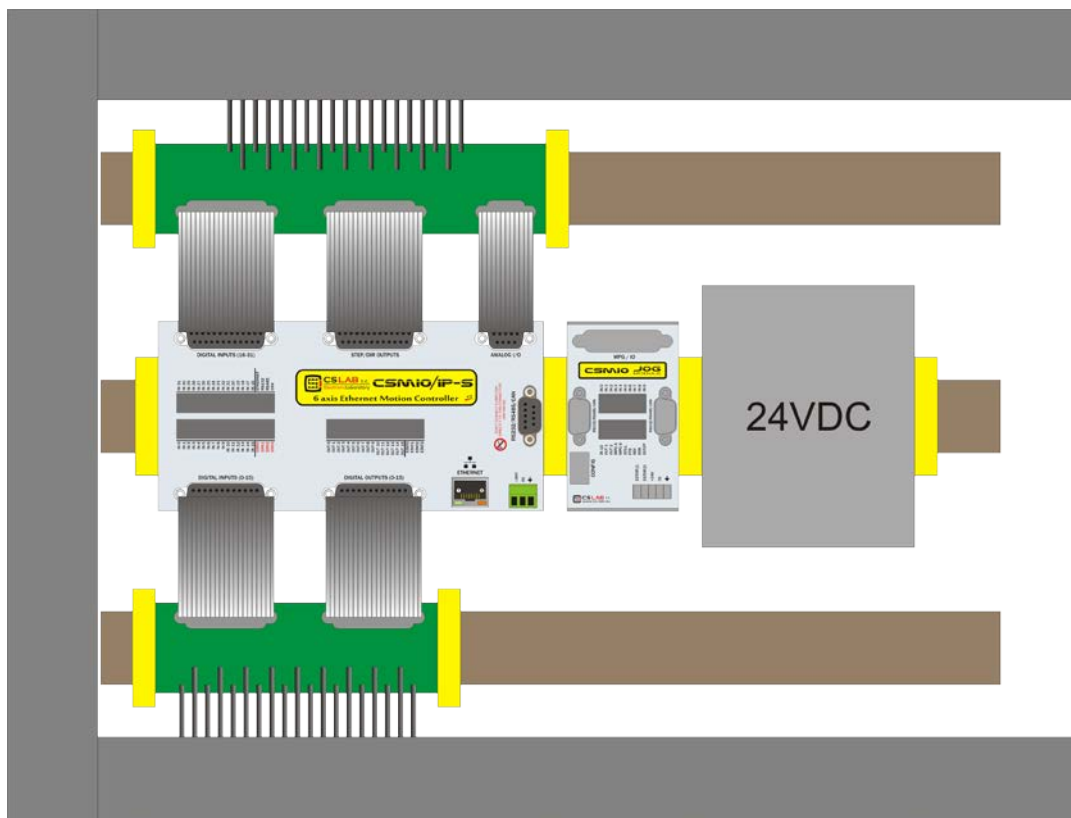

3.1.2 Control cabinet made by CS-Lab Company



Caution is advised during mechanical and electrical installation. Poorly tightened cable may cause many problems, it is also very difficult to find such a defect while launching/using the system.



4. Connectors, controls and electrical installation of the device

4.1 Connectors arrangement on the device

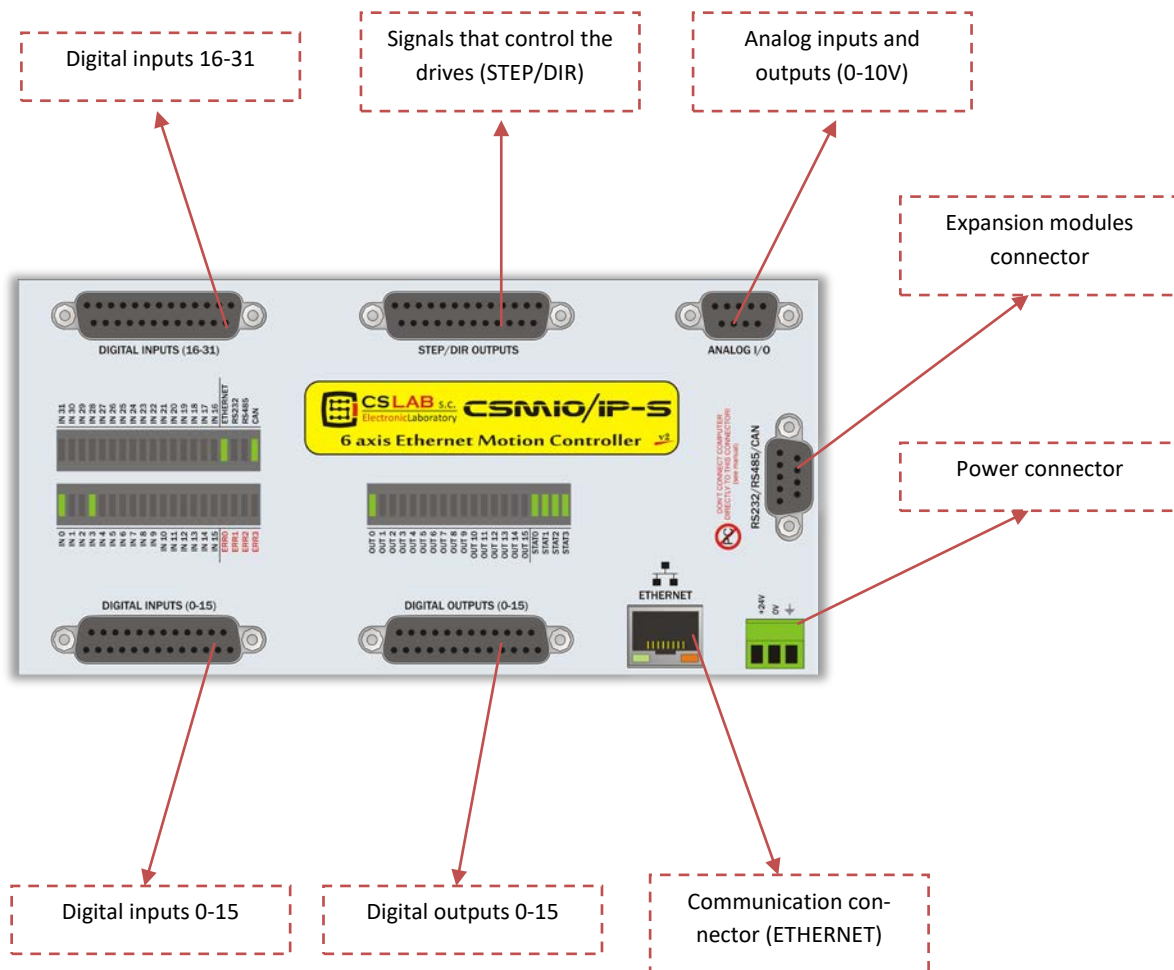

Detail description of signals on each connector is placed in the next sections.

i DB Terminal block connectors have the same pin numbers as DB connectors in CSMIO/IP-S device. In example: 15 pin of DB25 connector match with the 15 pin on the terminal block.

! If your CSMIO/IP controller is older than 2012: There were some hardware improvements made in the CSMIO/IP-S v2 controllers therefore the pin topology on STEP/DIR, DIGITAL OUTPUTS and DIGITAL INPUTS connectors is different for version v1 and v2. To define your version of the controller read the first 4 figures of a serial number.

- Numbers starting with 1119... and below means version v1
- Numbers starting with 1120... and above means version v2
- Since 2015 there has been the FP4 version for Mach4 and simCNC software support (FP4 sign placed on CSMIO/IP front panel)



4.2 STEP/DIR controlling signals connector (CSMIO/IP-S v2)

CSMIO/IP-S controllers v2 have serial number starting with 1120... and above.

PIN number	Details
1	DIR[0]+
2	STEP[0]+
3	DIR[1]+
4	STEP[1]+
5	DIR[2]+
6	STEP[2]+
7	DIR[3]+
8	STEP[3]+
9	DIR[4]+
10	STEP[4]+
11	DIR[5]+
12	STEP[5]+
13	GND
14	DIR[0]-
15	STEP[0]-
16	DIR[1]-
17	STEP[1]-
18	DIR[2]-
19	STEP[2]-
20	DIR[3]-
21	STEP[3]-
22	DIR[4]-
23	STEP[4]-
24	DIR[5]-
25	STEP[5]-

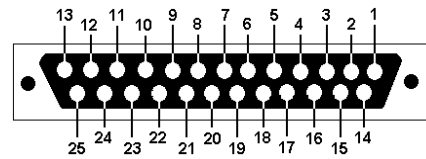

Do not ever connect differential outputs together!

Signals signed as „-“ cannot be connected to GND as it will cause device damage.

If you have never connected differential outputs you must read our additional documentation necessarily: [„CSMIO/IP differential outputs“](#) where are shown possible kinds of connection to different type drives. .



The 5V power that is available on this connector has low permissible load (50mA / pin) and serves only to control the LEDs in the optically isolated inputs of motor drivers.



Pay attention to version of the controller



During STEP/DIR signals connection to a drive (both servo and stepper) you should pay attention to which STEP edge is active. In the controller, a rising edge is the active edge so it is STEP+ signal change from "0" to "1". Connecting the controller e.g. of M542 stepper motor you should connect the PUL+ signal to STEP+, and STEP- output with CSMIO/IP-S to the PUL- of the controller. This way switching on the optocoupler in M542 will follow at rising edge of CSMIO/IP-S STEP signal. Improper connection may cause position errors.



4.2.1 Signals on a Terminal Block connector

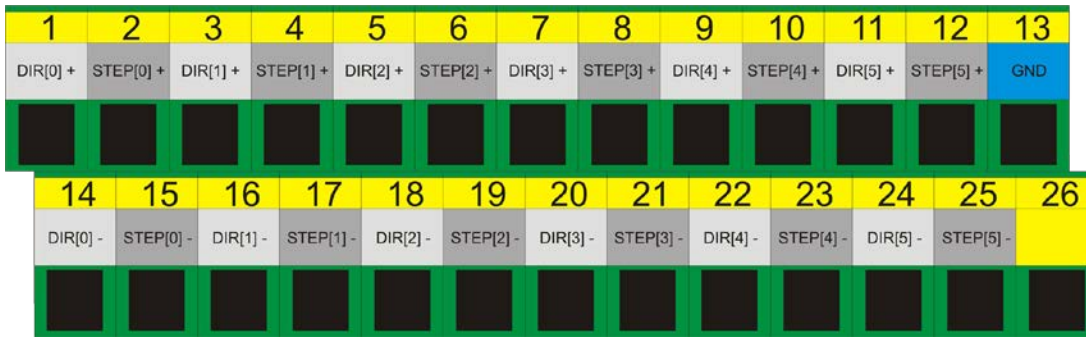

By default, axes are assigned to following channels STEP/DIR: X→[0] / Y→[1] / etc. Pin numbers Entered in Mach3 software in „Port&Pins” on „Motor Outputs” tab do not matter. If you want to assign other STEP/DIR channels numbers to an axis, you should do it in the plugin's configuration: menu „Config→Config PlugIns→CONFIG”.

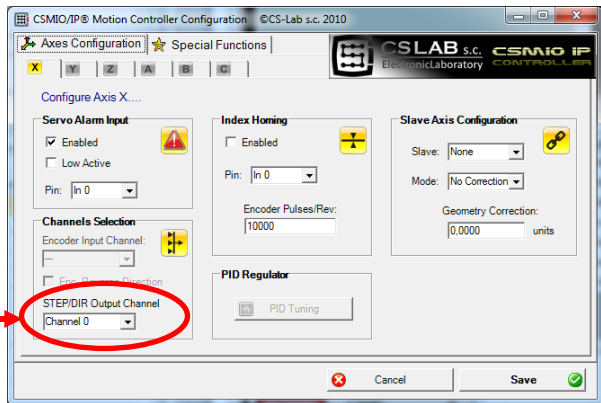

4.2.2 Example – M542 drive connection

In the example below there was shown connection of M542 drives as X drives.

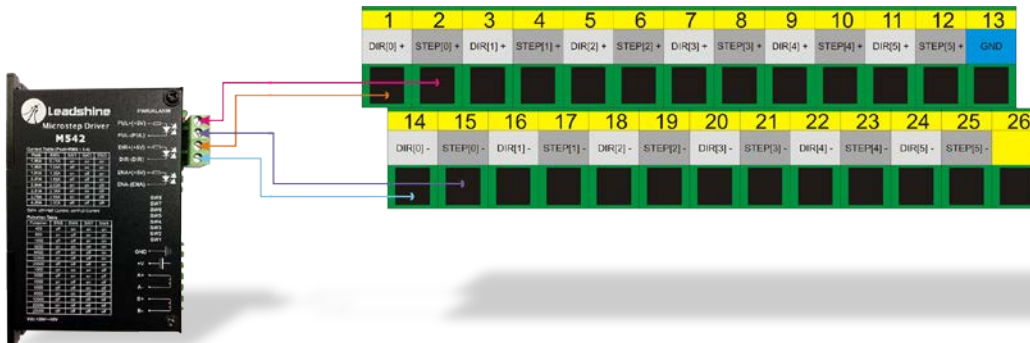



4.3 Digital outputs connector (0-15) (CSMIO/IP-S v2)

CSMIO/IP-S controllers v2 have serial number starting with 1120... and above.

PIN number	Details
1	24V power supply for 0-3 outputs
2	Output 0
3	Output 2
4	24V power supply for 4-7 outputs
5	Output 4
6	Output 6
7	24V power supply for 8-11 outputs
8	Output 8
9	Output 10
10	24V power supply for 12-15 outputs
11	Output 12
12	Output 14
13	GND (not in use)
14	Power supply 0V for 0-3 outputs
15	Output 1
16	Output 3
17	Power supply 0V for 4-7 outputs
18	Output 5
19	Output 7
20	Power supply 0V for 8-11 outputs
21	Output 9
22	Output 11
23	Power supply 0V for 12-15 outputs
24	Output 13
25	Output 15

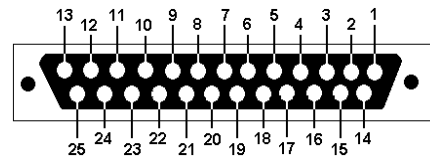

The outputs have 250mA permissible load. Pay attention if you are connected to a large inductance you may need to use an additional surge led, preferably as close to the coil as possible.



In Mach3 „Port&Pins” configuration, the value in „Pin” column does not mean a pin number in CSMIO/IP connector but it means output number.

It means that entering „9” refers to output 9, and so Pin 21 in CSMIO/IP connector.



4.3.1 Output circuits construction

As you can see on the scheme, each input is optically isolated. Outputs are divided into groups, four in each group.

Each group is controlled by specialized chip VNQ860. These chips work in PNP logic, thus the active state is a high state (+24V).

VNQ860 circuits are not powered from the same source CSMIO/IP is. If they were, the opto-isolation would have no sense. Therefore, we must remember to supply power to each group of outputs we use.

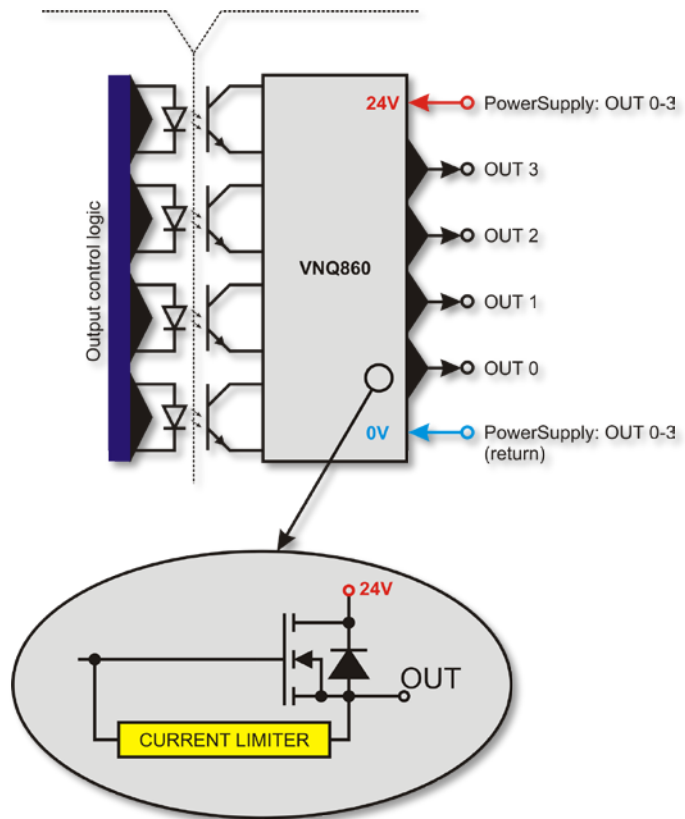

If we do not care about CSMIO/IP controller and digital outputs supply potentials separation and we want to use one supply source then we can link power supply of all the groups (pins 1, 4, 7, 10) and connect to controllers +24V supply. Of course you must also connect supply primary lines, 0V (pin 14, 17, 20, 23) to GND of CSMIO/IP controller power supply.

4.3.2 Signals on a Terminal Block connector

1	2	3	4	5	6	7	8	9	10	11	12	13
+24V (Wy. 0-3)	Wy. 0	Wy. 2	+24V (Wy. 4-7)	Wy. 4	Wy. 6	+24V (Wy. 8-11)	Wy. 8	Wy. 10	+24V (Wy. 12-15)	Wy. 12	Wy. 14	
14	15	16	17	18	19	20	21	22	23	24	25	26
0V (Wy. 0-3)	Wy. 1	Wy. 3	0V (Wy. 4-7)	Wy. 5	Wy. 7	0V (Wy. 8-11)	Wy. 9	Wy. 11	0V (Wy. 12-15)	Wy. 13	Wy. 15	



4.3.3 Examples – spindle switching signal

In the example below, basing on spindle switching output configuration (M3) we can see exactly following dependency: [Mach3 software signal] → [CSMIO/IP signal] → [Pin in CSMIO/IP connector]

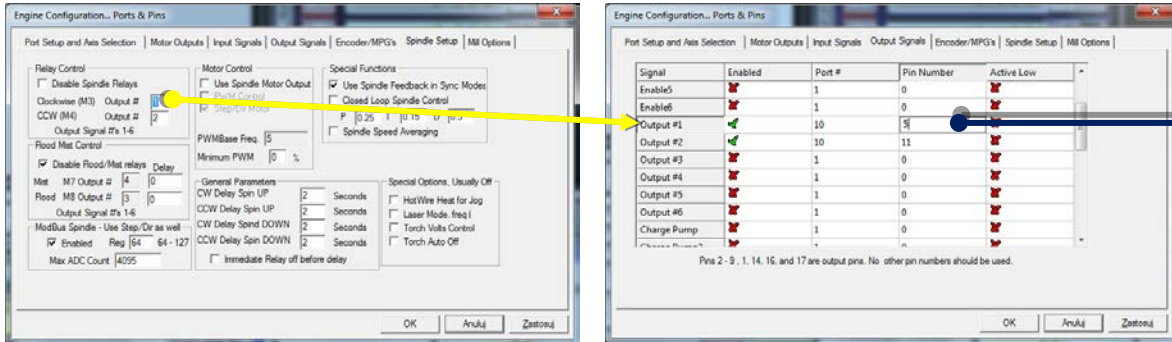

PIN number	Description
1	24V power for outputs 0-3
2	Output 0
3	Output 2
4	Power 24V for outputs 4-7
5	Output 4
6	Output 6
7	Power 24V for outputs 8-11
8	Output 8
9	Output 10
10	Power 24V for outputs 12-15
11	Output 12
12	Output 14
13	GND (not used)
14	GND 0V for outputs 0-3
15	Output 1
16	Output 3
17	GND 0V for outputs 4-7
18	Output 5
19	Output 7
20	GND 0V for outputs 8-11
21	Output 9
22	Output 11
23	GND 0V for outputs 12-15
24	Output 13
25	Output 15

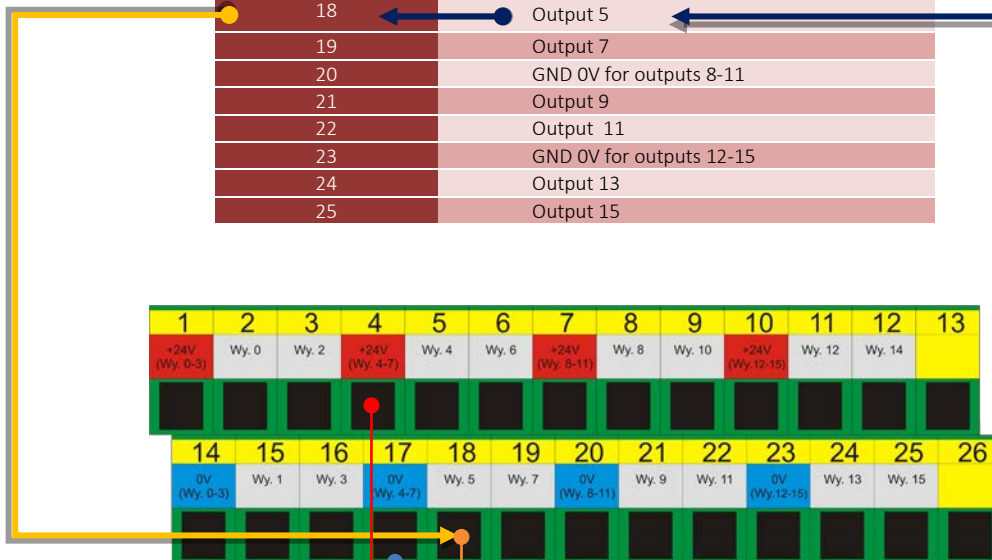

Outputs group power (4 – 7)

Output no. 5 of CSMIO/IP Controlling Signal (e.g. for inverter)



4.4 Digital inputs connector (0-15) (CSMIO/IP-S v2)

CSMIO/IP-S controllers v2 have serial number starting with 1120... and above.

PIN number	Details
1	Input 0 (+)
2	Input 2 (+)
3	Input 4 (+)
4	Input 6 (+)
5	Inputs 0-7 (-)
6	Input 8 (-)
7	Input 9 (-)
8	Input 10 (-)
9	Input 11 (-)
10	Input 12 (-)
11	Input 13 (-)
12	Input 14 (-)
13	Input 15 (-)
14	Input 1 (+)
15	Input 3 (+)
16	Input 5 (+)
17	Input 7 (+)
18	Input 8 (+)
19	Input 9 (+)
20	Input 10 (+)
21	Input 11 (+)
22	Input 12 (+)
23	Input 13 (+)
24	Input 14 (+)
25	Input 15 (+)

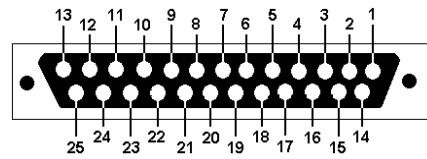

Pay special attention to not exceed the permissible voltage (30VDC) on the inputs lines. It may cause the device damage.



In Mach3 „Port&Pins” configuration, the value in „Pin” column does not mean a pin number in CSMIO/IP connector but it means output number. It means that entering „10” refers to input 10, and so Pin 20(+) and 8 (-) in CSMIO/IP connector



4.4.1 Input circuits construction.

You can see below simplified scheme of CSMIO/IP-S input circuits. On the scheme outputs: 0 – 15 are signed as IN 0 – 15.

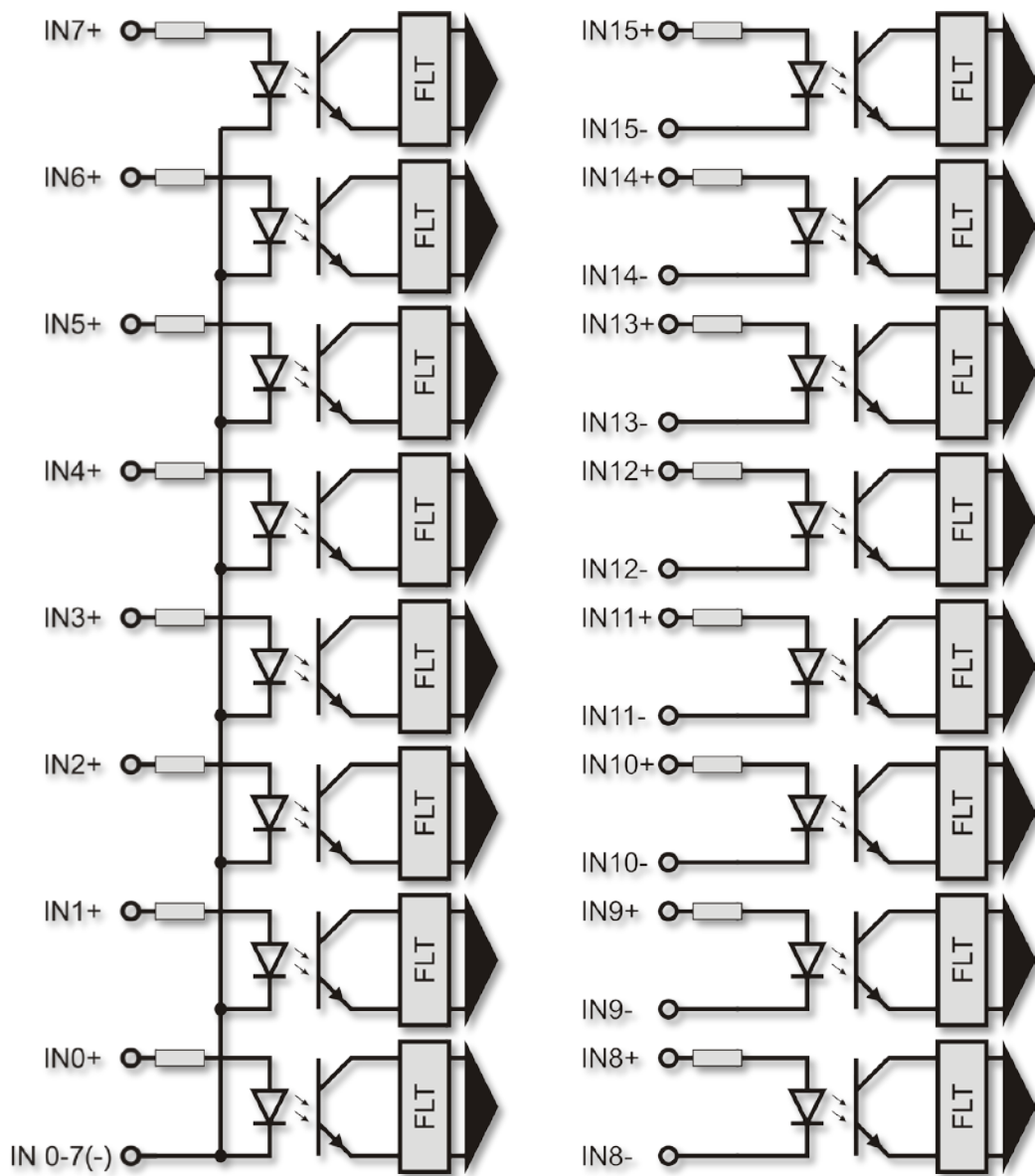

4.4.2 Signals on a Terminal Block connector





4.4.3 Examples of input signals connection

4.4.3.1 Inductive sensor PNP type

In this example sensor with PNP type output was connected to input no. 5. In Mach3 software, we give in this case: port=10 / pin=5.

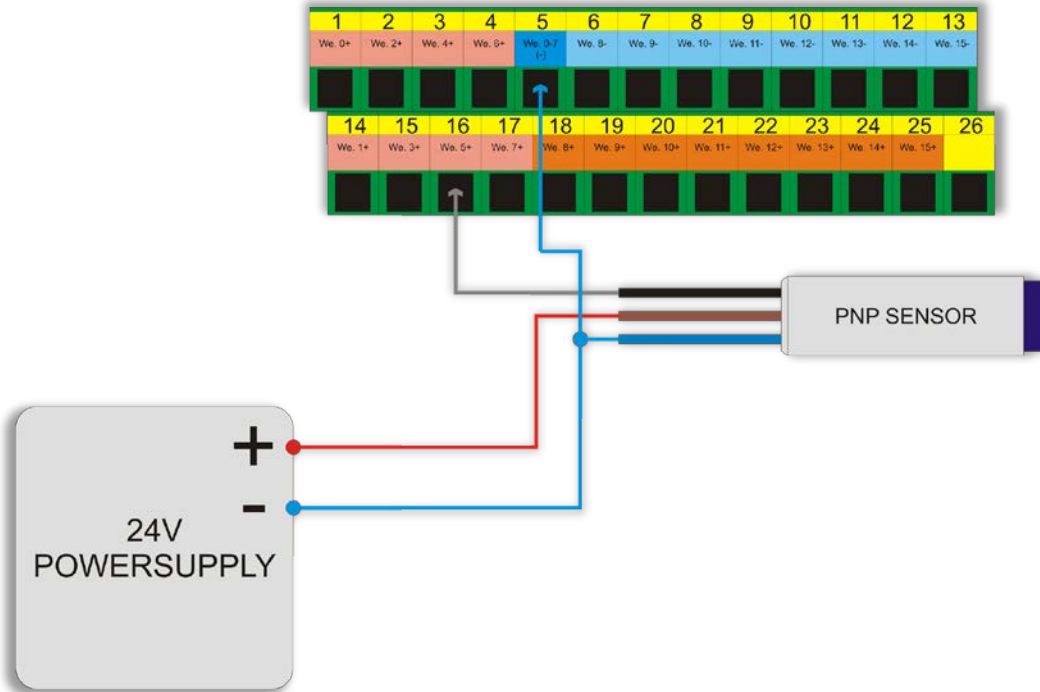

4.4.3.2 Inductive sensor NPN type

In this example sensor with NPN type output was connected to input no. 8. In Mach3 software, we give in this case: port=10 / pin=8.

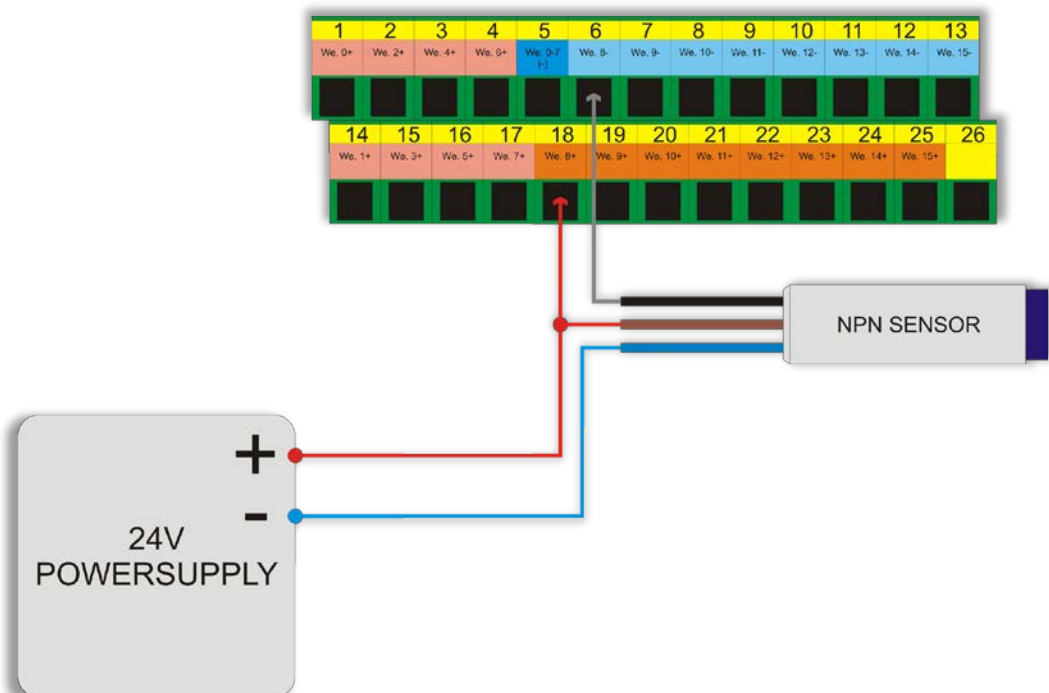



4.4.3.3 Common connector NC type

In this example sensor with NPN type output was connected to input no. 11 of CSMIO/IP. In this case, in Mach3 software we give: port=10 / pin=11.

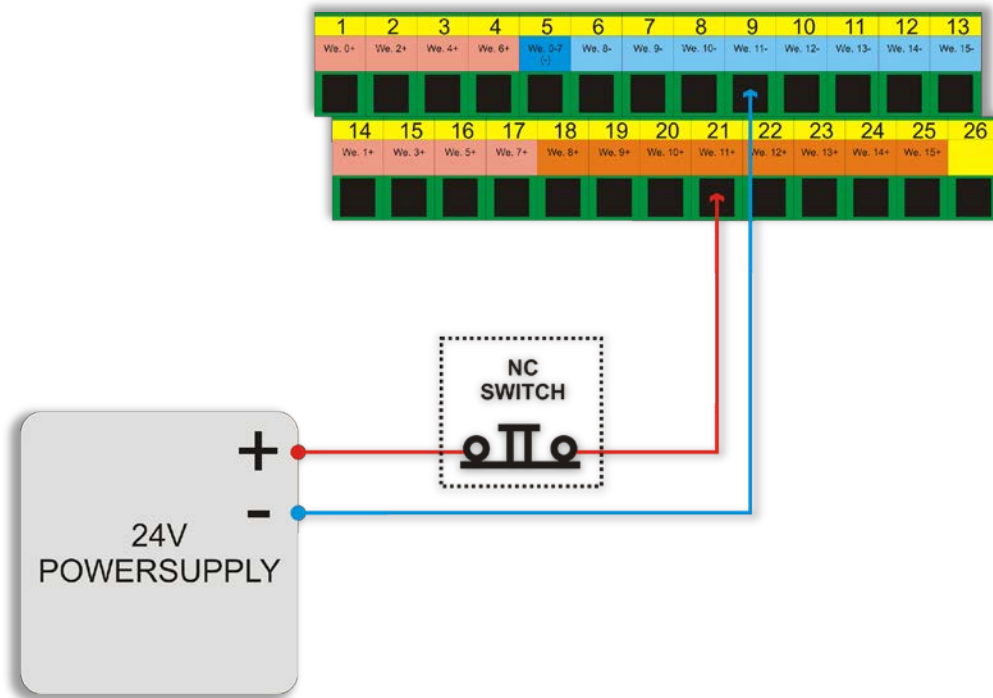



4.5 Digital inputs connector (16-31) (CSMIO/IP-S v2)

CSMIO/IP-S controllers v2 have serial number starting with 1120... and above.

PIN number	Details
1	Input 16 (+)
2	Input 18 (+)
3	Input 20 (+)
4	Input 22 (+)
5	Input 16-23 (-)
6	Input 24 (-)
7	Input 25 (-)
8	Input 26 (-)
9	Input 27 (-)
10	Input 28 (-)
11	Input 29 (-)
12	Input 30 (-)
13	Input 31 (-)
14	Input 17 (+)
15	Input 19 (+)
16	Input 21 (+)
17	Input 23 (+)
18	Input 24 (+)
19	Input 25 (+)
20	Input 26 (+)
21	Input 27 (+)
22	Input 28 (+)
23	Input 29 (+)
24	Input 30 (+)
25	Input 31 (+)

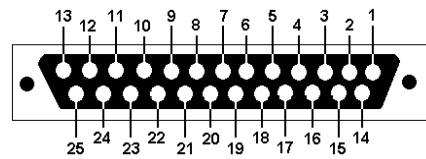

Pay special attention to not exceed the permissible voltage (30VDC) on the inputs lines. It may cause the device damage.



Inputs: 16 – 31 have identical construction as inputs: 0 -15. Look at inputs: 0 – 15 description in previous section, you will find there sample connections.



4.6 Analog inputs/outputs connector

PIN number	Details
1	Analog output 0
2	GND
3	Analog input 1
4	Analog input 2
5	10V (max. 50mA)
6	Analog output 1
7	Analog input 0
8	GND
9	Analog input 3

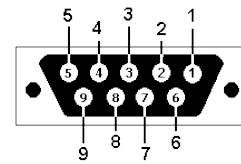

Analog outputs no. 0 and 1 have max. load of 100mA. Exceeding this value may cause damage of the device.



Pay special attention not to exceed the permissible voltage (10VDC) on the inputs lines. It may cause damage of the device.



10V output has 50mA load and serves only to supply the potentiometers, if you want to connect the potentiometers, such as regulation of feed rate or spindle speed correction.



Connecting analog signal from plasma generator you must remember that it should be galvanically isolated signal!
Connecting with use of simply voltage divider do not protect against surges and may cause controller damage.

4.6.1 Signals on a Terminal Block connector

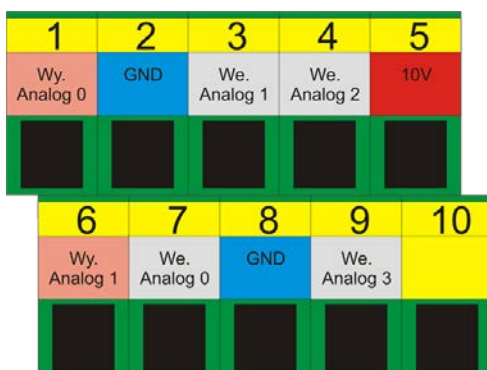



4.6.2 Example – connection and configuration of potentiometers

Below you can see example of connection and configuration of potentiometers for adjusting feed rate correction and spindle revs.

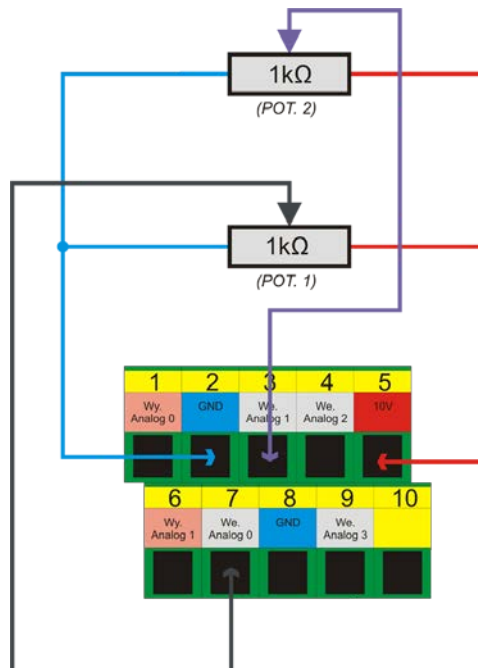

As you can see on the scheme - having 10V on an analog connector is very comfortable – thanks to it, we do not need any external power to supply potentiometers. Potentiometer 1 was connected to analog input no. 0, and potentiometer 2 to analog input no. 1. After connection you can check it by analog inputs preview in diagnostic window – menu „PlugIn Control→CSMIO_IP plugin”, „Analog IO” tab.

If values on analog inputs change along with potentiometer knob position, then the only thing left is to configure the plugin.



Open configuration window – menu „Config→Config PlugIns→CONFIG”. Select „Override Src.” tab.

We select „CSMIO-IP AIN 0” for „Feed rate override” – so for feed rate adjustment the POT.1 potentiometer will be used.

For „Spindle speed override” we chose „CSMIO-IP AIN 1”, so for spindle revs adjustment the POT.2 potentiometer will be responsible.

Finally we click „Save” to remember the settings.

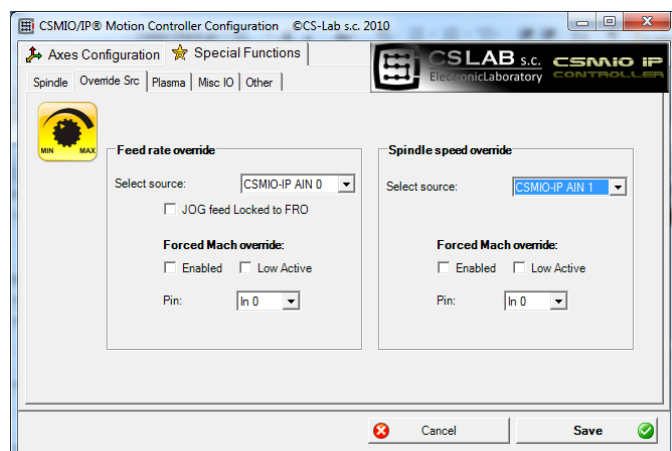



4.7 Expansion modules connector

PIN number	Description
1	CAN H
2	RS232 RxD
3	RS232 TxD
4	-
5	GND
6	CAN L
7	RS485 B-
8	RS485 A+
9	-

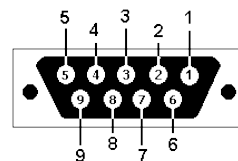

Connector serves only for CS-Lab s.c. expansion modules. Do not plug it into any others devices, PC, etc.

4.8 Power connector

Pin number	Description
1	Power – 24V DC
2	GND
3	ground

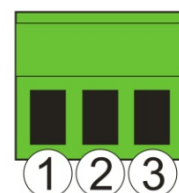

View of the plug from the side of connecting wires



Pay special attention to not exceed the permissible power voltage (30VDC) on the input lines. It may cause damage of the device.

If you use in the system such inductive loads as electromagnets, solenoids, electromagnetic clutches – it is recommended to use separate 24V power supply for the mentioned receivers and separate for CSMIO / IP-S.



4.9 Communication connector – Ethernet

PIN number	Description
1	TX+
2	TX-
3	Rx+
4	-
5	-
6	RX-
7	-
8	-

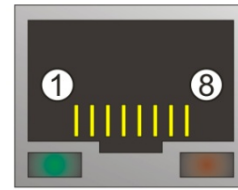

It is recommended to use shielded cable FTP or STP cat.6.

A network interface has no Auto MDI-MDIX function. So when we connect CSMIO/IP-S directly to a computer we should use so-called crossover cable. If you connect it to the network switch or router - use a non-crossover cable.



4.10 Recommended cables

Connections type	Recommended cable
Digital In/out	Minimum cross-section 0,25mm ² (AWG-23)
Analog In/out	Cross-section 0,25mm ² (AWG-23)- shielded or pair of signal-to-mass wires twisted together along the entire length
Drives control (STEP/DIR) CSMIO/IP-S v1	Cross-section 0,25mm ² (AWG-23)- shielded or pair of signal-to-mass weirs twisted together along the entire length
Drives control (STEP/DIR) CSMIO/IP-S v2	Cross-section 0,25mm ² (AWG-23) - shielded–twisted. You can possibly use the FTP computer cable. Please note that pairs of signals (e.g., STEP + / STEP-) you should always lead by twisted pair of cables.
Ethernet Communication wire	Standard Power cable, shielded - FTP, cat. 6.
Power	Min. Cross-section 0,5mm ² (AWG-23)
CAN expansion modules	If modules are installed on the same DIN rail, right next to the controller, you can use DB9 plugs clamped on a 9-wire tape. If module is installed farther then you should use so call shielded twisted pair. (FTP or STP).



During mechanical and electrical montage – particular caution is advised. Poorly tightened cable may cause many troubles, it is also very difficult to find such a defect during launching/using the system.



4.11 Installation examples

4.11.1 Inverter connection using an analog output.

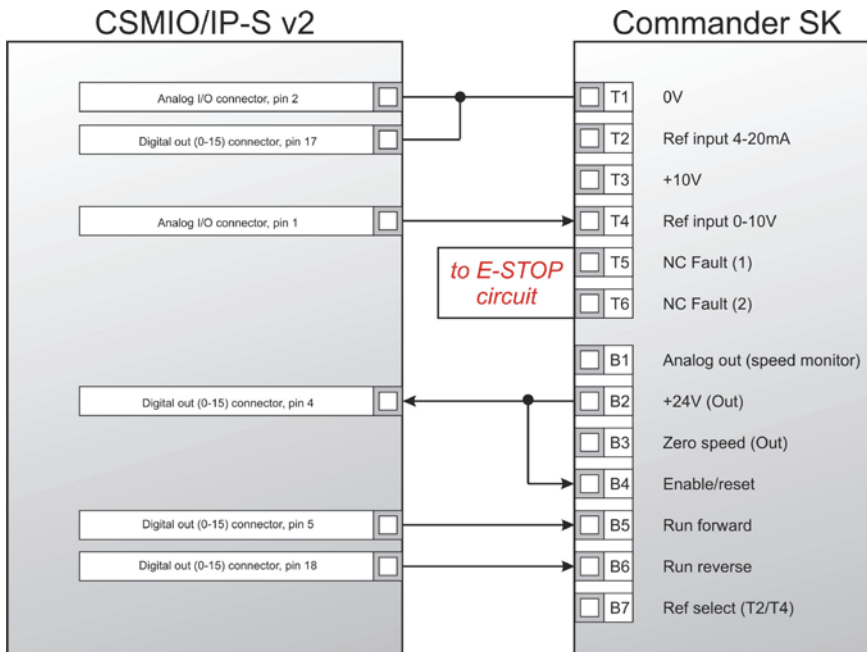

In the example above, you can see the simplest connection of an inverter to operate spindles in an engraving plotter.

CSMIO/IP-S outputs in use:

CSMIO/IP-S signal	Connector on CSMIO/IP-S	PIN numbers on CSMIO/IP-S (v2) connector	Inverter function
Analog GND connection	DB9 – Analog I/O	2	AGND – reference potential for analog input of a speed command
Analog output 0	DB9 – Analog I/O	1	AGND – reference potential for analog input of a speed command
CSMIO/IP digital outputs Power GND	DB25 – Digital outputs (0-15)	17	
Outputs 4 and 5 power	DB25 – Digital outputs (0-15)	4	24V output for controlling signals
Digital output 4	DB25 – Digital outputs (0-15)	5	Right revs switching
Digital output 5	DB25 – Digital outputs (0-15)	18	Left revs switching



Do not forget to set the configuration parameters of the inverter properly. Incorrect settings may cause - in the best case - the inverter error, in the worst - the spindle motor becomes permanently damaged (such damage is not covered by warranty).



Mach3 software configuration, concerning use of a spindle with revs control was described in chapter 10 - "Mach3 Configuration".



4.11.2 Illustrative diagram of XYZ plotter (CSMIO/IP-S v2)

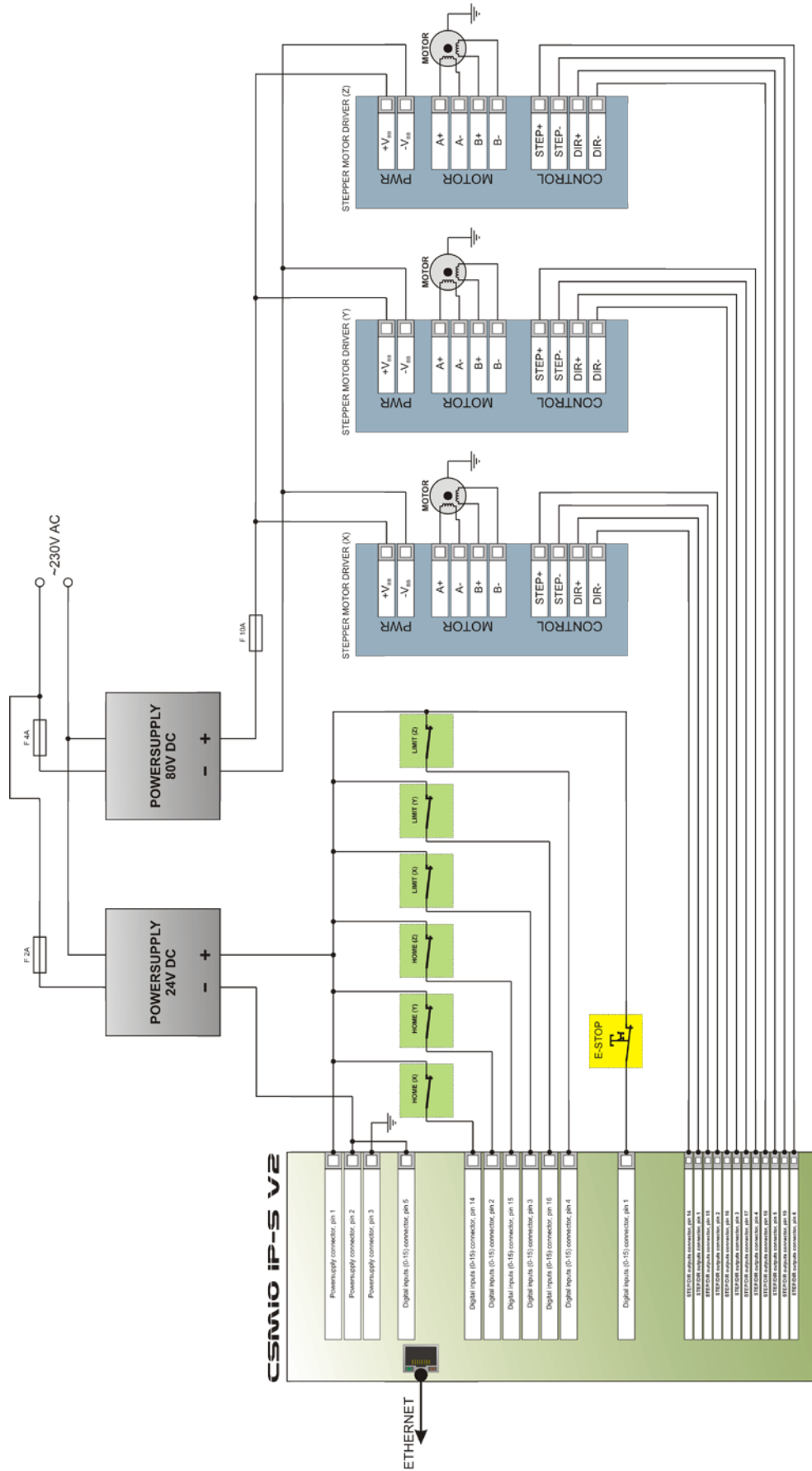



The scheme presented in this section is the simplest implementation of 3axis plotter (XYZ).

Two power supplies were used: 24V to supply the CSMIO/IP-S controller and 80V for the stepper motors drives. Switches used: normally close (NC) switches for axis homing (HOME) and limit switches (LIMIT). In practice, it is necessary to build more complex systems, however the example above shows the main rule.



4.11.3 Automatic control of drives power supply (HV)

The CSMIO/IP-S controller allows for automatic control of drives power supply and eventually some other devices. Switching on this function was described in Chapter 10th. The logic of the output operation, defined as so-called „HV Enable” is very easy. Voltage is enabled at the moment of Mach software “Reset” request and stays “on” until one of the following conditions exist:

- FAULT signal from any axis drive
- E-Stop signal (the emergency stop mushroom pressed)
- Limit switch activation
- Loss of communication with the Mach3 software
- Error of position/speed regulators inside the CSMIO/IP-S

Here is an example of connected outputs used as „HV Enable”. The output number is irrelevant, it is defined in the configuration window of the Mach3 software.

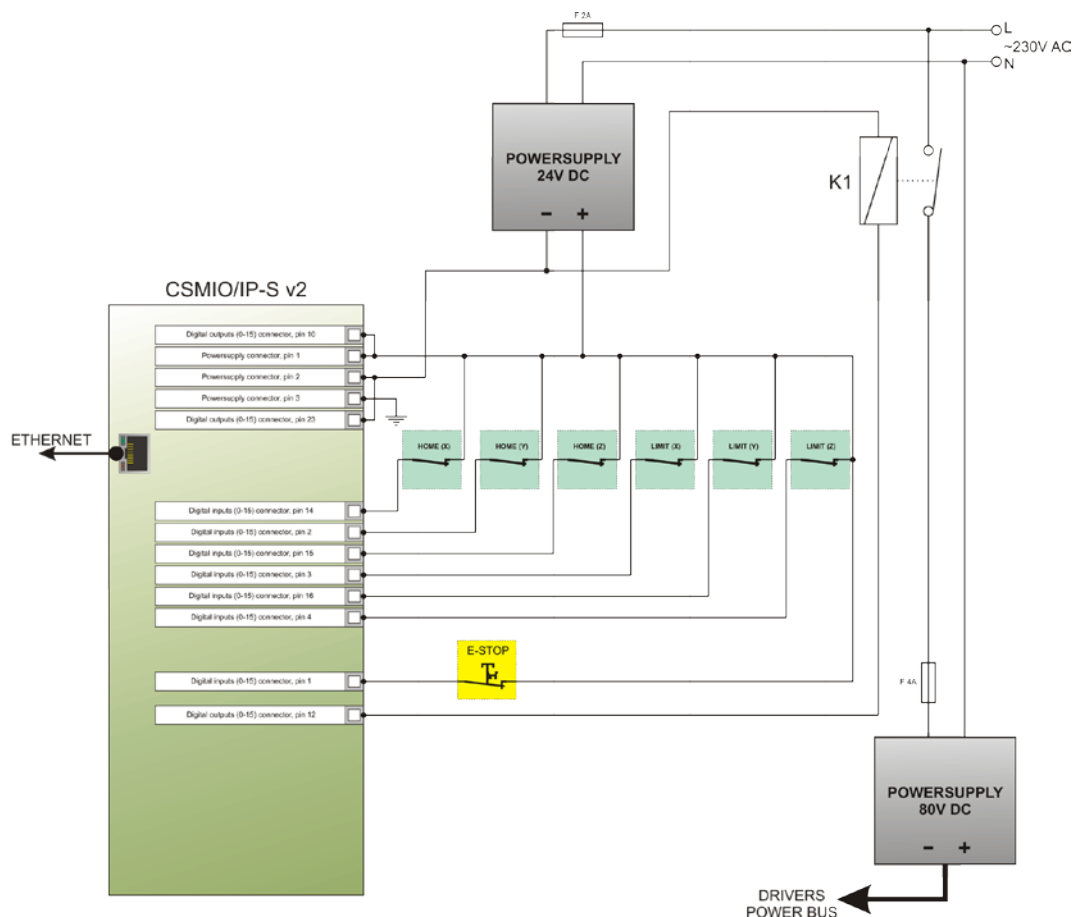

When you use large contactors for switching off the power, check if the coil doesn't take more than 250mA. If so, use smaller transmitter and turn on the bigger one with it. With a large contactor it's good to have a diode and noise-suppression condenser to eliminate the overvoltages generated during switching off the coil.



The „HV Enable” voltage control function is performed automatically by the CSMIO/IP-S controller. Response time for events that cause the disconnection is less than 1ms.



4.12 LED lights description

On the front panel of CSMIO/IP device, there are groups of LEDs that simplify verifying the correctness of electric installation and diagnostic of such components as HOME switches, LIMIT switches and safety switches (E-Stop) etc.

4.12.1 Types and location of the LEDs

Digital inputs 16-31 LEDs and communication ports activity LEDs

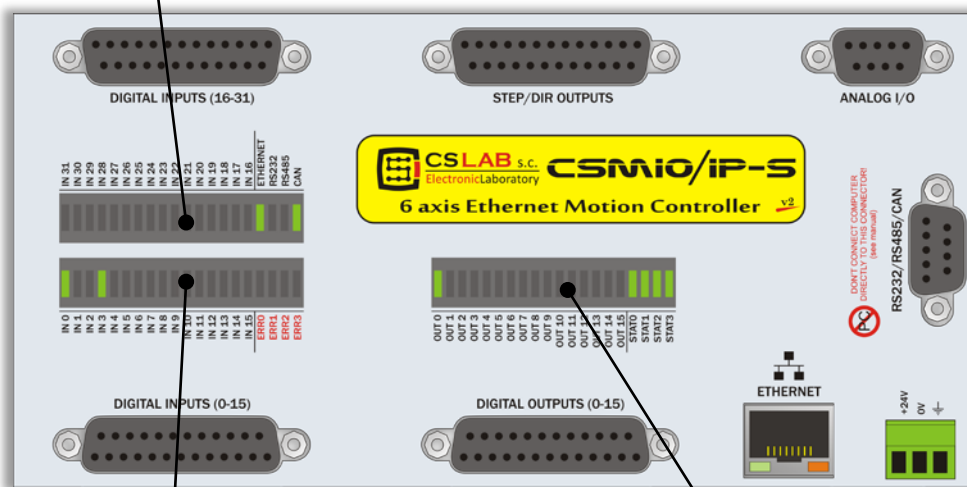











Digital inputs 0-15 LEDs and error signalization (ERRx) LEDs

Digital output 0-15 LEDs and device status signalization (STATx) LEDs



- Digital inputs and outputs LEDs do not require more explanations. For example, if you give the signal to the input no. 5, the **IN5** LED lights up. Similarly, if you switch on the output no. 2 – **OUT2** LED lights up.
- **CAN** diode lights up when at least one expansion module is connected and when the communication on the CAN bus is correct.
- **RS485** diode lights up if there is a communication on RS485 bus.
- **RS232** diode lights up if there is a communication on RS232 port.
- **ETHERNET** diode lights up if the controller communicates with a PC computer.
- **ERR0-ERR3** diodes indicate controller errors. During normal operation, any of these diodes should not light up. If any of them light up you should contact service – “contact” tab on <http://www.cs-lab.eu> website.
- **STAT0-STAT3** diodes indicate controller status, information about the status is very helpful information that CS-Lab service should get if there are any problems during the device work. Below you find detailed description of the lights meaning.



4.12.2 State diodes description - STATx

Diodes state: STATx	Description
 STAT0 STAT1 STAT2 STAT3	Standby, waiting for transmission of configuration parameters from a computer. It is a default state after switching power on, before communication with Mach3 software.
 STAT0 STAT1 STAT2 STAT3	Readiness state. It means that the device works correctly, there are no alarm signals, such as E-Stop or LIMIT. CSMIO/IP-S waits for the commands from the PC.
 STAT0 STAT1 STAT2 STAT3	It means that one or more axes are currently on a manual motion mode (JOG).
 STAT0 STAT1 STAT2 STAT3	It means one or more axes homing at the moment (HOMING).
 STAT0 STAT1 STAT2 STAT3	Buffering motion trajectory data.
 STAT0 STAT1 STAT2 STAT3	The controller is in a G31 command mode (tool measurement sensor touched, scanning etc).
 STAT0 STAT1 STAT2 STAT3	Mode of an interpolated motion on a trajectory– CNC software or MDI command performing. Also movement commands from the script level (macro) of Mach3 software cause this state.
 STAT0 STAT1 STAT2 STAT3	Emergency stop. It means active state appears on an input line defined as the E-Stop or E-Stop call from the Mach3 level.
 STAT0 STAT1 STAT2 STAT3	Alarm state. It appears when controller work was stopped as a result of problems detection. This state can be caused by such situations like: FAULT signal of servo drive, hardware limit switch signal, working area exceeded at SOFT-LIMIT function switched on, etc.
 STAT0 STAT1 STAT2 STAT3	Others. This state shows appears on case of other additional functions such as: rigid tapping, etc.

i Explanations:

-  → LED light is off
-  → LED lights continuously
-  → LED light flashes



5. Recommendations and drives selection (motors drives)

Choice of appropriate motors for a machine is very individual. In this chapter, we describe briefly differences between stepper and servomotors. Designer practice shows there is a dilemma – what solution should be chosen. Not so long ago – stepper motors were more popular in simpler machines because of high prices of servo drives. Presently, technological progress and a dissemination of servo technology causes that building a machine – even as a hobby – it is worth to consider servo drives.

The most common mistake while decision-making is power selection (and torque) of the servo drive. It happens because we are suggested by torque and holding torque. The first parameter is usually given with the servo drives and the second with the stepper motors. Both are usually in the same unit Nm (Newton – meter). Do not compare these parameters when you are choosing servo drive power. Holding torque in the stepper motors is a power that the shaft of the powered motor in standby mode is held in position. When the revs are very low –

something about 200 rpm - the torque is almost the same (pictures below), but with increasing revs the torque, actually the power on the motor shaft), decreases drastically. It decreases to such low value that sometimes happens that at 1000 rpm. the motor has no power to work itself, not saying about propelling the machine.

In the simple words: the 3Nm stepper motor, reaches 3Nm torque on very low (200 rpm.) revs, when the revs increase its power decrease to zero. Above, on the left you can see example stepper motor characteristic.

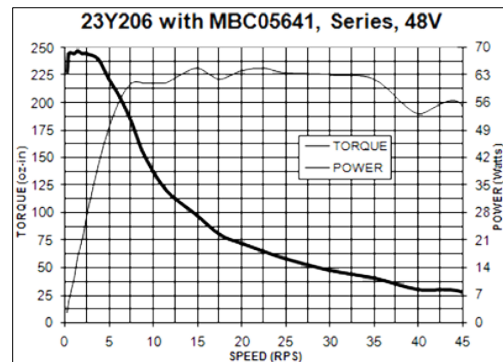

It is completely different in the servomotors. First, the torque and the rev speed are nominal. Therefore, the 1Nm/ 2000 rpm motor can operate continuously with revs: 2000 rpm. and at this speed provides 1Nm of the torque on the shaft. Besides the servomotors have another one important feature: they can be temporarily overloaded. What does it mean? That the 1Nm motor can temporarily deliver even 2,5-4Nm (it depends on the type).

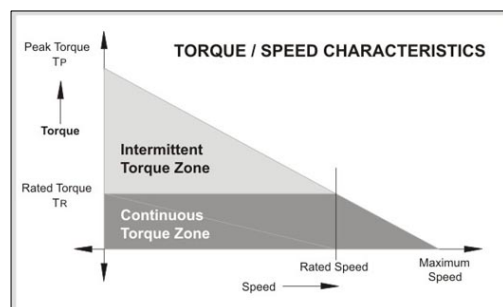

If we use the motion controller with fast STEP outputs like CSMIO/IP-S, the important parameter of the motor drive is maximum frequency of the steps. Controllers with higher frequency limit of STEP signal allow you to use higher stepper division (for the stepper motors) or encoders with larger pulses number per rev (servo).



However, everything has its pros and cons. So what are the disadvantages of servo drives? They are certainly more expensive - how much, it depends what kind of stepper and servo drives you compare. There are e.g. stepper motors controllers that cost 800 USD and there are some other that cost 40 USD (with the same power!). Generally we can conclude that the servo motor + drive package is more expensive. Other disadvantage of the servo drives is necessity for PID controllers tuning and wiring that is more complicated. That will be the end of the disadvantages. Great advantage of the servo drives is that - thanks to the feedback - the servo drive indicates the overload and positioning error. When the CSMIO/IP-S receives this signal immediately stops the axes. In the stepper motors there is no feedback like this one, so even if one of the axis because of e.g. overload will not keep the set trajectory, the machine will continue the work – breaking the same entire processed detail.

In sum – we recommend the servo drives. Their disadvantages are negligible in comparison to the benefits they offer. Please note that the servo drive can have much lower nominal torque than holding torque of the stepper motor. When we compare the 3Nm stepper drive and 3Nm servo drive – the price difference may be significant. However, if we compare the 3Nm stepper drive with the 1Nm servo drive, the price difference is not so big.

Practice shows that sometimes - mechanically identical machines are sold in two versions, with 3Nm stepper and 1Nm servo drives. The machine with the stepper motor reaches max 7,5m/min feed rate and 0,1g. acceleration. The machine with the servo drive reaches 20m/min feed rate and 0,4g. acceleration. If we add the feedback, which was mentioned before, further comparing is pointless.

The choice is in your hands of course, in some solutions the stepper motors are adequate and work very well. Thanks to perfectly precise STEP signal timing of the CSMIO/IP-S controller the stepper motors behave much better then while controlling from e.g. the LPT port. We can use a higher stepper division, so the motors will work quieter, smoother and they get higher revs by reducing the resonance.



6. Precise homing with encoder INDEX signal

Homing with use of so-called encoder INDEX signal is another argument for servo drives. This type of homing is very precise even if the HOME switch has large dispersion of the trip point. In practice, homing with the INDEX allows to eliminate inaccuracy of the HOME switch.

CSMIO/IP-S is STEP/DIR type controller and does not have an encoder input. It does not mean that it is impossible to base on INDEX. You can use built-in CSMIO/IP-S function or function of synchronization HOME signal and INDEX in servo drive.

6.1 Solution no. 1 – Homing on “index” function

In plugin configuration window there is a possibility to chose homing mode for each axis, with or without index.

The configuration was described in detail in section 10.

The solution has the advantage that CSMIO/IP controller is able to specify a distance between home switch-off activation on and index position and in situation when the distance is to small – axis homing will be stopped. It is very comfortable and safe solution, because if index is close to Homing activation position there may be some homing errors with even entire motor rev.

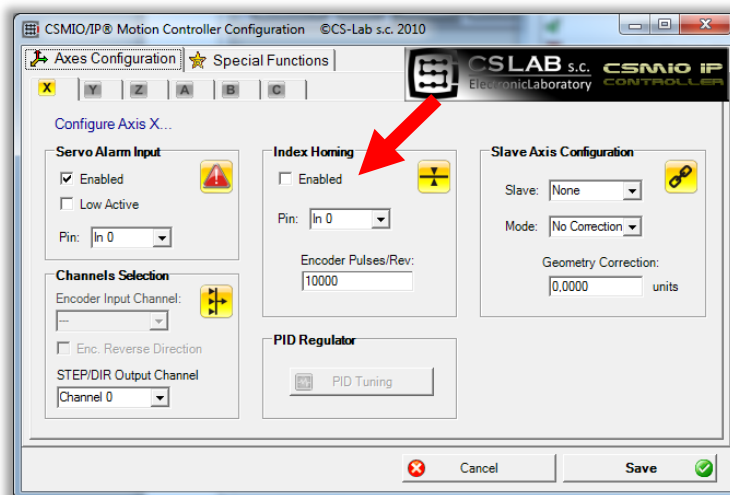

That is why, during function configuration we also give pulses number per rev and CSMIO/IP verifies whether index is in safe distance (minn15 degrees, or so 1/24 motor revs).

According to the fact that CSMIO/IP-S has no encoder inputs, index signal is connected to standard digital inputs of the controller. The problem is that the controller requires 24V logic signals. However many servo drives have index output “open collector” - type and then we can handle it easily.

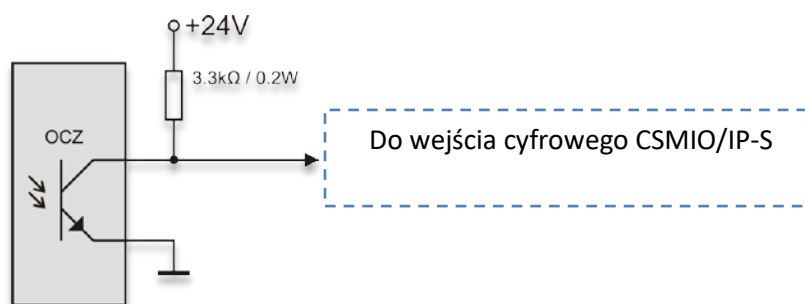

As it is shown - pull-up resistor is enough. However sometimes we do not have “open collector” –type output available, then the only way for homing on index is to add external, simply electronic system:

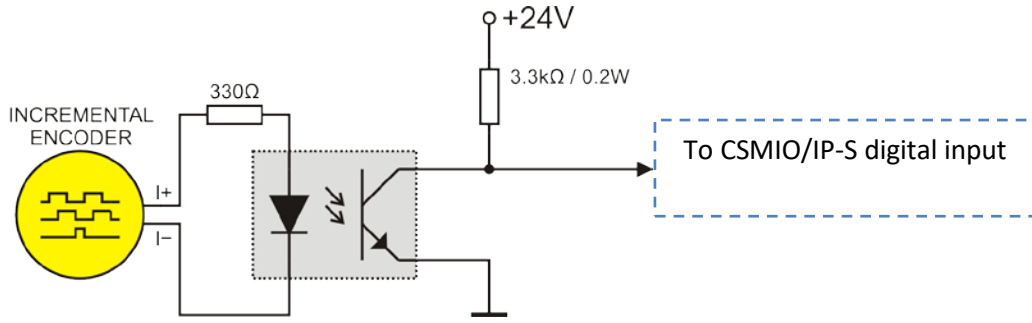

In this case, we must use directly the encoder signal or servo drive TTL encoder output. Aesthetic connection will be in this situation a little troublesome.

i Choosing servo drives we should pay attention to that they have index output “open collector” – type. Thanks to it, we connect index signal to the CSMIO/IP controller without any problems. These output you can find in servo drives by CS-Lab s.c. (<http://www.cs-lab.eu>) simDrive, servo drives by Delta (<http://www.delta.com.tw>).

6.2 Solution no. 2 – Synchronization of HOME signal in servo drives.

To do the homing on INDEX this way we need the servo drive with a function of HOME signal and encoder index synchronization. In between offered by our company the simDrive Servo drive has this function.

Below – the rule of connection with homing on index.

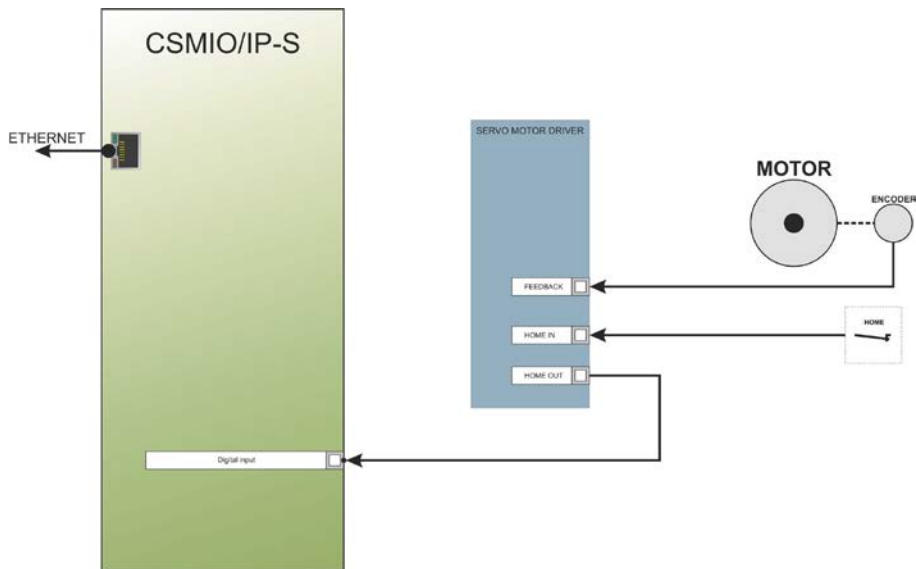

In a situation when you are choosing a servo drive and you want to see if it will be possible to do homing on index, the HOME signal synchronization should look like this:

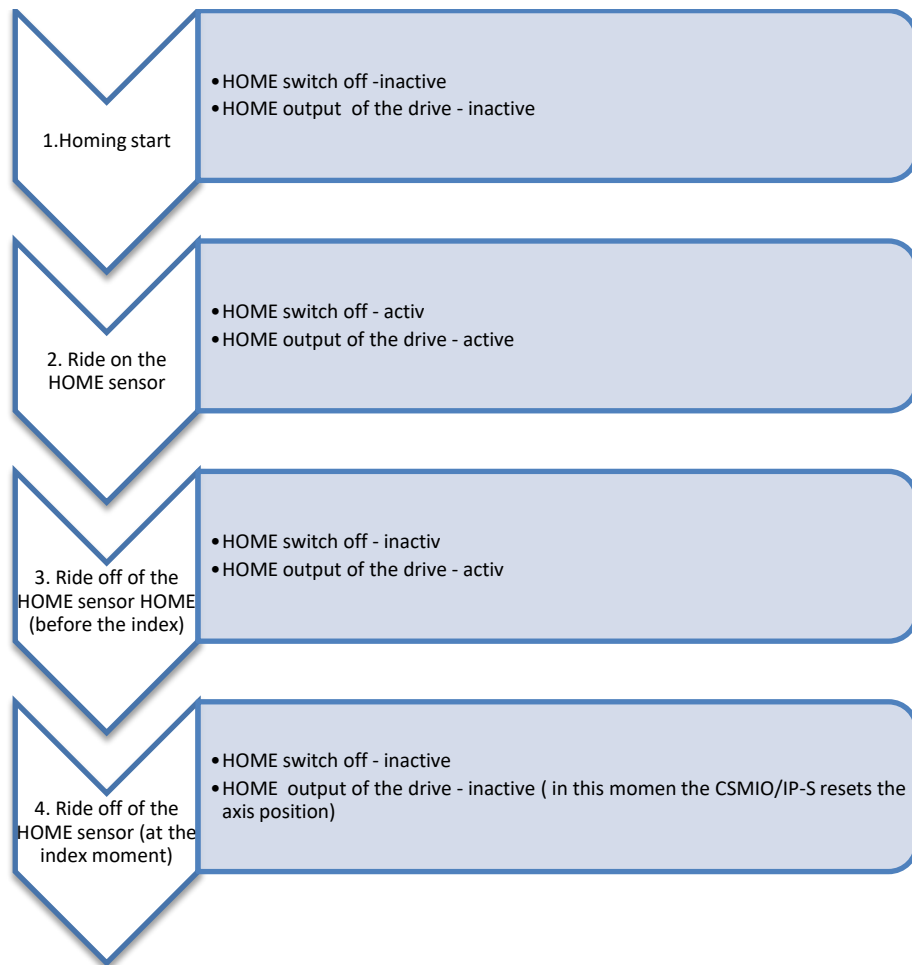

As shown on the diagram above, the drive should extend the active state on the HOME output until it step on the encoder index. During the tests with simDrive the achieved homing accuracy at 2000mm/min speed and encoder's 10000imp/rev - ranged +/-1 imp. of the encoder.

That detailed homing is useful in practice, because after power failure or E-Stop pressing or any other incident that causes that we need to re-home, we are sure that there will be no trace in a place where the process was continued.

i Homing algorithm in the CSMIO/IP-S is made in such way, that the base point does not change even after acceleration and/or speed for the axis changed. It gives the possibility to adjust the acceleration parameter during the process (requires a temporary stop, configuration parameters change and re-homing).

! You should note that at the moment you back off the HOME switch, the rotor should be turned for min. 15° to the index point, because - if the index would be very close to the Home switch travel back off point then homing dispersion may occur. In case the back off point and the index are too close, you have to adjust the HOME switch position. Do not regulate on the encoder!



7. LAN connection and configuration

7.1 Direct connection to PC

CSMIO/IP-S controller can be connected directly to the PC, without any switches or routers. With this connection, you should remember to use the crossover cable. CSMIO/IP set includes the cable. Below – how to perform the wiring.

Plug-in 1	Cable color	Plug-in 2
1	white-orange	3
2	orange	6
3	white-green	1
4	blue	7
5	white-blue	8
6	green	2
7	white-brown	4
8	brown	5

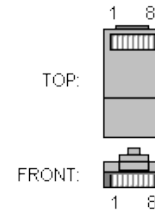

For direct connection, you should set static IP address on your computer: 10.1.1.1 and mask: 255.255.255.0.

7.1.1 Windows®XP configuration.

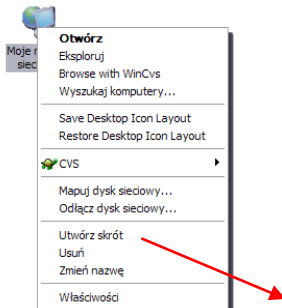

- Click right mouse button on „My Network Places” icon and select „Properties” position from the menu. You will see window with the icons/icon of network connections.

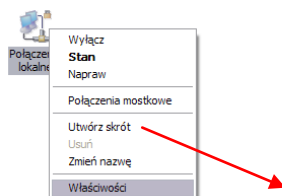

- Click right mouse button on the icon of a connection we want to use to communicate with CSMIO/IP (usually it is “local connection”) – then choose „Properties”.

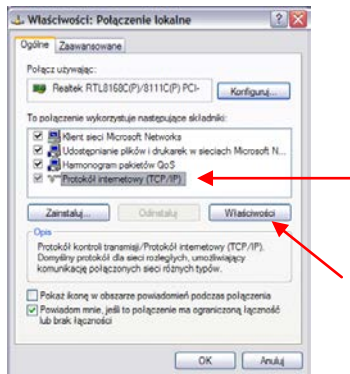

- In this window – select the „Internet protocol (TCP/IP)” position and click left mouse button on the „Properties”.

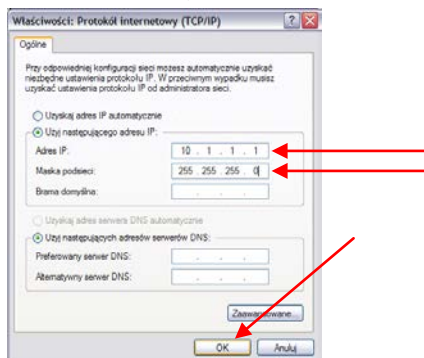

- In this window enter the IP address: 10.1.1.1 and mask: 255.255.255.0. Click “OK”.
- Close the window.
- The network is now set to work with CSMIO/IP.

7.1.2 Windows® 7 configuration.

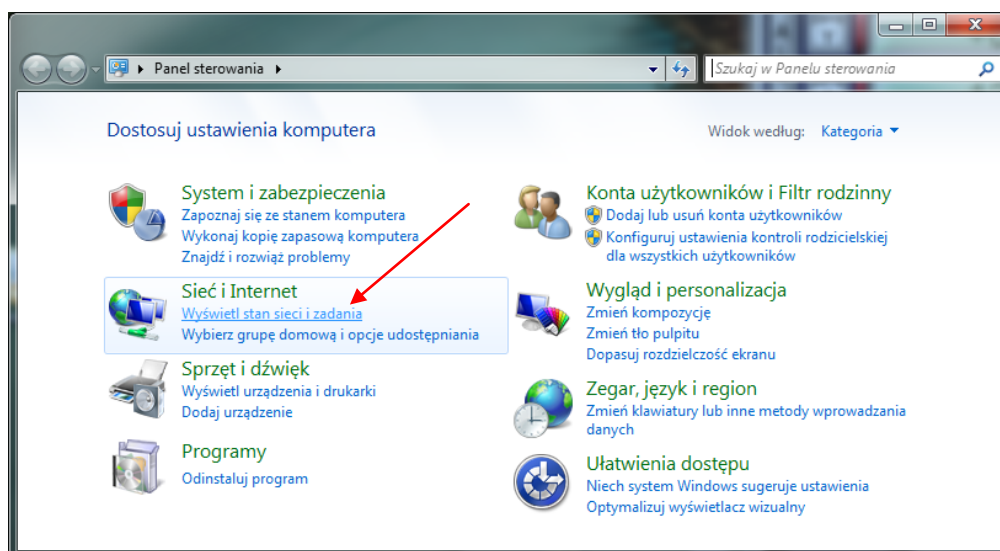

In control panel, we choose „View network status and tasks”

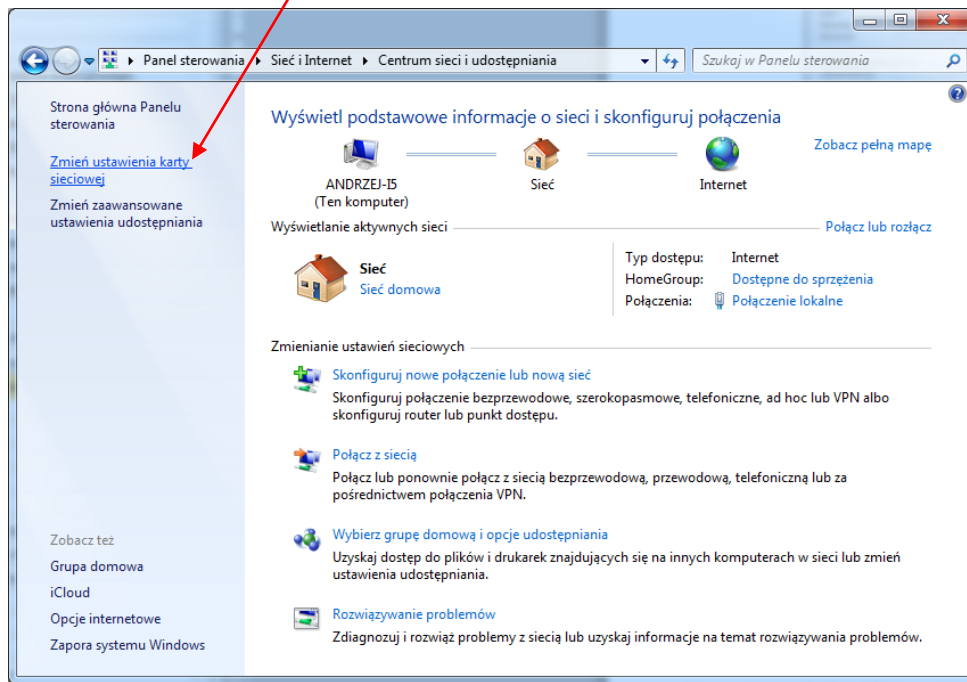

Next - select „Change adapter settings”.

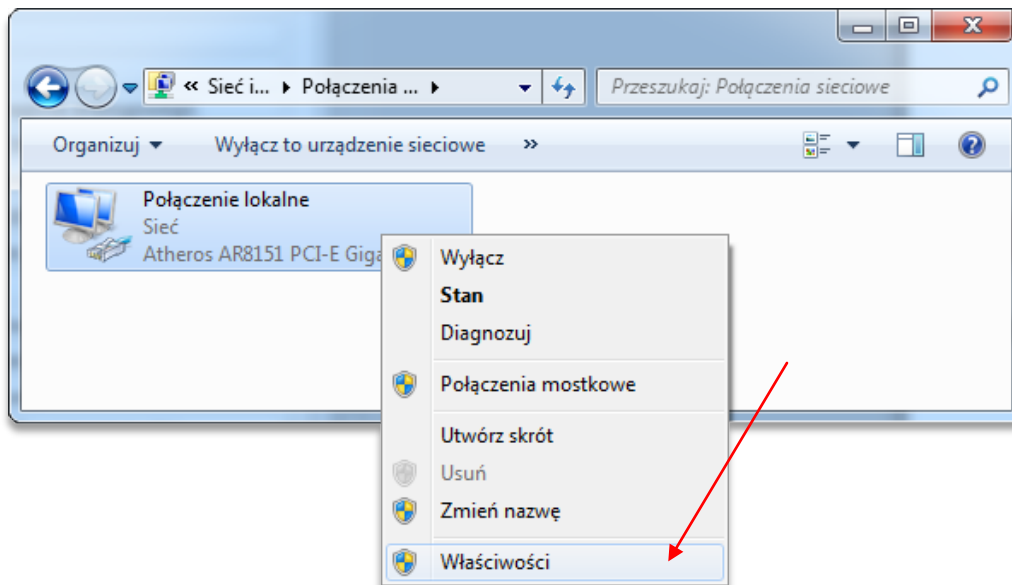

Click with right mouse button and select “Properties” of network connection.

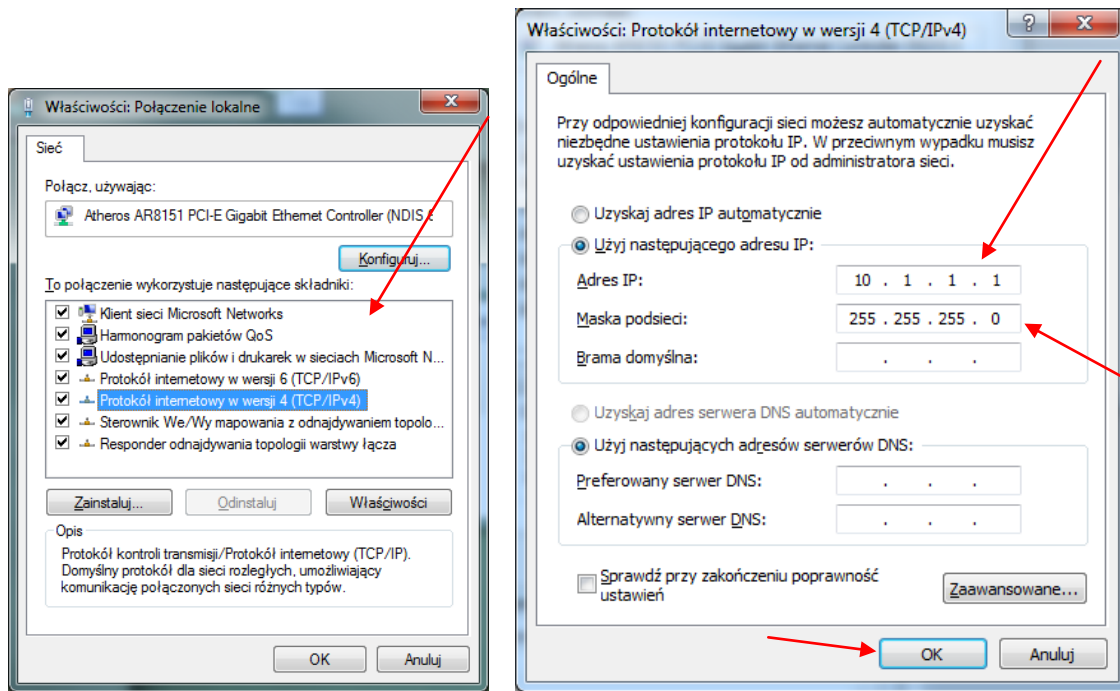

Double click on TCP/IPv4 protocol, and next enter the address IP: 10.1.1.1 and network mask: 255.255.255.0. Confirm with OK.

i After CSMIO/IP- controller initialize it tries to set its IP automatically at first (it sends request to the DHCP server). After three failed attempts, with no response from the server- the default IP address is set to: 10.1.1.2. It does not last longer than 10 sec. but you should remember to wait 10 sec. after switching the power on, to let the controller communicate.

! Even though the ethernet connection is highly resistant to interference - remember to use shielded cables, especially if you use servos or spindles with high power.



7.2 Local network with router and DHCP.

If we plug the CSMIO/IP-S controller in to the computer network where is a router that allocates IP addresses, the device automatically downloads the address and network mask settings.

Usually there is no need to know what IP address was assigned to the device because the plug-in and the application that updates the controller software automatically searches the CSMIO/IP-S in the network. However if you want to know what IP address the controller has, you can find it out from the router's configuration page (the controller is called **CSMIO-IP-xxxx**, where xxxx are the last four figures of MAC's hardware address). Here is an example screenshot of the DHCP server where you can see the CSMIO/IP device in the network.

IP Address	Ethernet	Hostname	Start Date	End Date
192.168.10.145	00:04:a3:13:2c:a1	CSMIO-IP-2CA1	2011/03/08 17:20:05	2011/03/08 19:20:05
192.168.10.130	00:04:a3:13:2d:0c	CSMIO-IP-2D0C	2011/03/08 17:21:59	2011/03/08 19:21:59

When you connect the CSMIO/IP-S controller to a network with router, you should use a non-crossover cable (so called Straight Thru, or 1:1). The wiring way is shown below:

Plug 1	Cable color	Plug 2
1	white-orange	1
2	orange	2
3	white-green	3
4	blue	4
5	white-blue	5
6	green	6
7	White-brown	7
8	brown	8

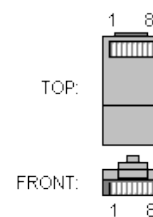

In most cases, the crossover cable attached to the device will also work, because most routers have function of cable type auto-detect, so called AutoMDX. Do not worry. In no case, there will be no damage, even if the router does not have the function mentioned above.



Even though the ethernet connection is highly resistant to interference - remember to use shielded cables, especially if you use servers or spindles with high power.



8. Mach3 software – general information



Mach3 software of ArtSoft® Company has developed over many years and during these years, it gathered many users. For relatively low price (~170USD) we get complete solution for multi-axis CNC machining. Key benefits of the software are:

- Flexibility
 - Ability to create own user interfaces, transparent and suited to specific machine applications. There is a special visual editor where you can create the Mach3 interface design from the beginning or use already existing project. On the internet, there are many ready solutions. Below – one of the most visually attractive interfaces available on www.machmotion.com.



- Ability to self-extend the functionality of the software through macros, written in simple and known by many people - VisualBasic®. It allows you to implement a variety of measurement probes, automatic tool length measurement, automatic storage of tools in many variants etc.
- Plug-ins support, which further extend functions of the software and allows for cooperation with outside motion controllers. Connection with CSMIO/IP-S controller is made by that plug-in, made by our company.
- Easy to use
 - Those, who are already little familiar with CNC machines are able to learn all the general functions and rules of using the Mach3 software – within one day.
 - Configuration of the key parameters is transparent and intuitive, so they can be quickly adjusted to the requirements of a specific machine.
- Dynamic analysis of the trajectory
 - CNC software is analyzed in advance, so it allows for optimal adjustment of motion speed at every point of trajectory. Thus, the software is done quickly, but with full smoothness of the motion.



-  CS-Lab Company is an authorized distributor of Mach3 and Mach4 software in Poland. If you would like to buy the license, please contact us: office@cs-lab.eu.
-  Please note that Mach3 software serves only to operate a machine - it is not possible to design, draw, etc. Indeed, there are functions that allow for CNC code generation for simple operations, but it is better to have a CAM type software, like ArtCam, MasterCam, etc.



8.1 Recommended PC configuration

The Mach3 software does not have any unreasonable requirements about a PC computer, unless tool paths you use take even up to tens of megabytes – then we would recommend a bit faster computer. Even simulation of a runtime with so large paths will follow more efficiently on faster PC computer.

Recommended PC configuration:

- Processor Intel CoreDuo 2GHz
- 2GB RAM
- Graphics card 512MB



On a computer used to control a machine there should not be any other software except Windows® and Mach3 software installed. Designing and all other tasks should be performed on other computer. A computer used to control the machine can be connected to a computer network, but remember about good anti-virus protection.



It is recommended to disable all visual effects in Windows® system, also a screensaver. Set power scheme – “always on”.

If the computer is placed with the rest of control system in a control cabinet – then remember to close the Windows® system before turning off the power. Otherwise, it may be very soon necessary to reinstall the operating system.



9. Software installation

Before we begin our work, we should install the Mach3 software and plugin that ensures proper co-operation of the software and the CSMIO/IP controller on a PC computer.

9.1 Mach3 installation

The latest version of Mach3 software you can download from ArtSoft® website: <http://www.machsupport.com/downloads.php>

After the file is downloaded, you should launch it and follow the screen instructions. Generally, you should just press the „Next” button. In the window with components to install selection – uncheck the „Parallel Port Driver” position. It is a parallel port driver that is unused with CSMIO/IP controller.

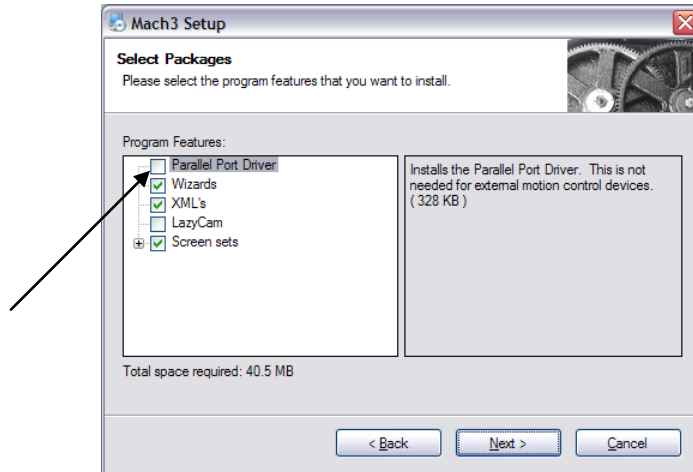

Next, we can create a configuration profile, which we are going use. You can also create the configuration profile later. If we want to do it during the installation, then – click selecting your machine type:

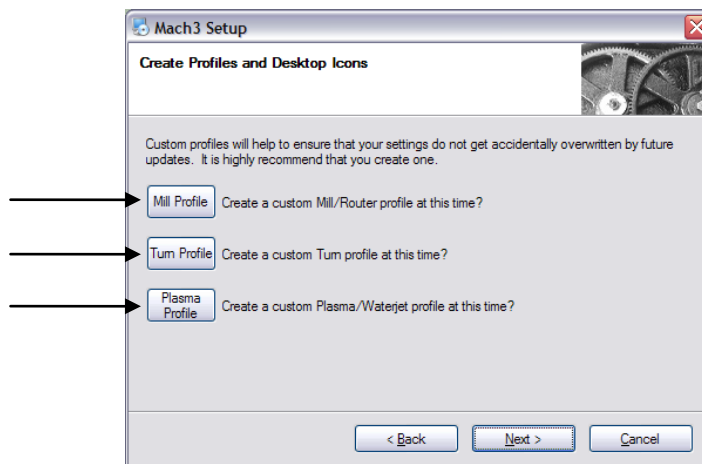

- Mill profile - milling machine
- Turn profile - lathe
- Plasma - plasma or gas cutter



After you click one of the buttons, you will see a window to name your configuration profile, e.g.:
 “MyMillingMachine_400x250_CSMIO_IP”.
 Avoid spaces and special signs (an underscore is allowed).

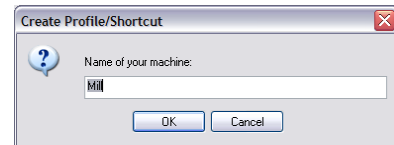

9.2 Microsoft® .Net installation (older operating systems)

If you use OS older than Windows® 7, it may be necessary to install Microsoft® .Net. This software is available on Microsoft® website and on CS-Lab Company website: http://www.cs-lab.eu/artykul-11-CSMIOIPS_Download.html

For proper installation, you have to be connected to the Internet. The installation is automatic, you should only approve next steps and restart your computer when it is finished.

9.3 Installation of CSMIO/IP firmware

CSMIO/IP firmware is provided as a convenient-to-use installer. Setup proces is very fast and does not take even a minute.

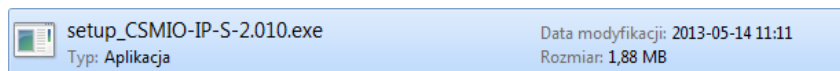

Run setup file

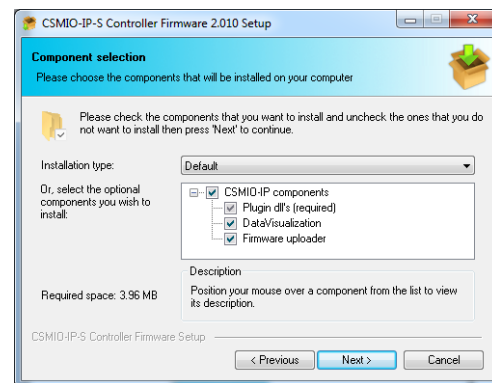
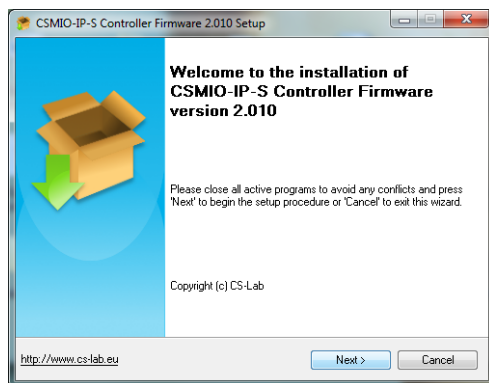

Click „Next” and ... again „Next” – there are no reasons to modify installed components.

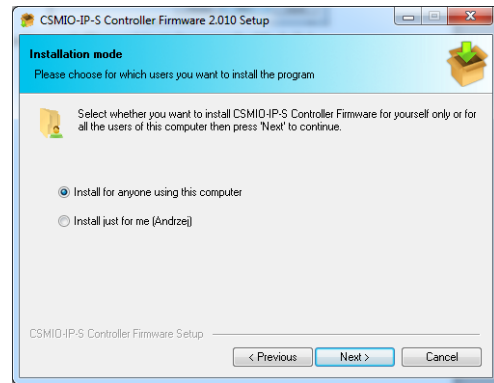
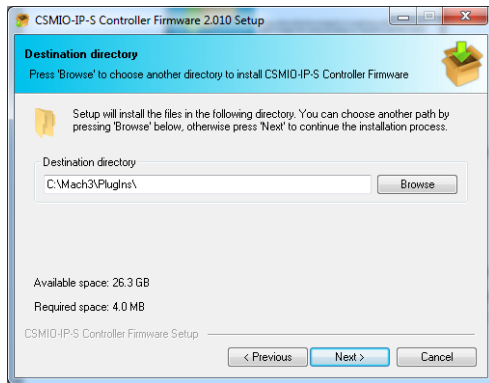

Next, we can choose a path for Mach3 software and decide if it should be installed for all users. Mostly we just leave the default settings and then double-click „Next”.

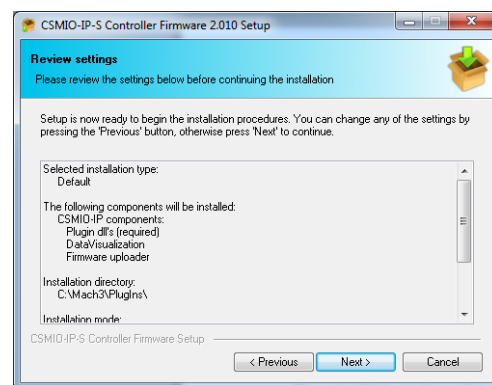
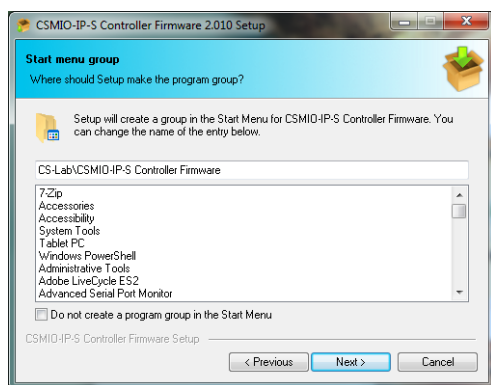

Name selection in start menu - mostly there is no need to change anything here also - click „Next” and again „Next” when you see a summary review.

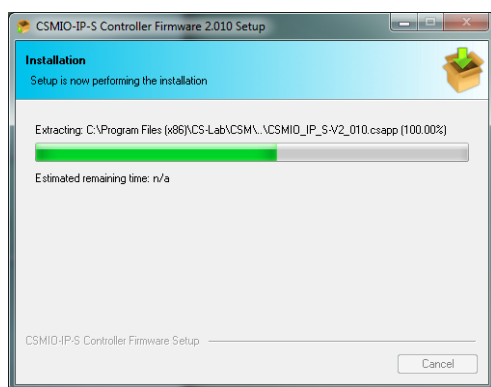

After this lasting few seconds setup another window will show up - with question if you want to launch CSMIO/IP controller firmware that serves to controller updates. If you are not sure if you have the latest version, you can update it now. Update process was described in B Addition.

If you do not want to update now deselect the „Launch CSMIO/IP-S Controller Firmware” option and click „Finish”.



Mach 3 plugin and CSMIO/IP-S firmware must be the same version. Update the controller firmware if needed. The update process is described in the addition section - „CSMIO/IP firmware updating”.



9.4 Administrator rights in Windows® Vista and Windows® 7

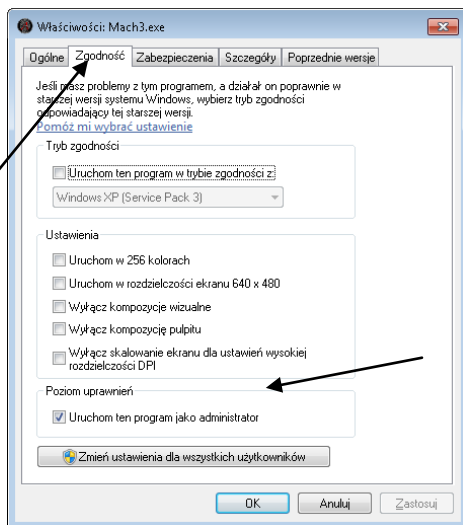

It is recommended to launch Mach3 software in Windows® Vista, Windows® 7 and Windows® 8 operation systems with administrator rights.

Open „C:\Mach3” directory, find Mach3.exe file and click right mouse button. Select “Properties” position from the menu, and next select the „Compatibility” tab.

Next, select the „Launch this software as administrator” and click „OK”.

From now, the Mach3 software will always run with administrator rights.



10. Mach3 software configuration

After software installation, you should configure it all to match the settings and the controlled machine with whole its electrical system.

Elements that should be configured:

- Scale-up of each axis (namely how many pulses per millimeter/inch).
- Speed and acceleration settings for each axis.
- Assignment of in/out signals:
 - Signals of homing sensors – HOME
 - Signals of axis limits – LIMIT
 - Signal of an emergency stop – ESTOP
 - Signal of tool measurement probe/ homing etc.
 - Additional inputs signals e.g. desktop buttons etc.
 - Alarm signals of servo drives – FAULT
 - Drives reset – DRV_RESET
 - Drives voltage enabling– HV_ENABLE
 - Outputs that activate spindle, cooling etc.
- Slave axis configuration (if used).
- VisualBasic® scripts configuration.
- Axis range settings for the SoftLimit function (software limits).
- Homing speed settings
- Software design customization (eventually).

Configuration is an individual matter for each machine; anyway, in the next sections you will find some general rules.

10.1 Configuration profile creation

If during the installation you did not create a configuration profile (Chapter 9), it is worth to create it now. In this profile will all the settings of configured machine tool be saved.

After Mach3 software installation, you should see new icons on your desktop, „Mach3 Loader” icon among them - launch the software clicking on it. A „Session Profile” window will appear. To create a

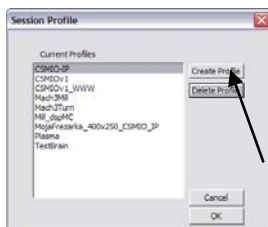

profile click on the „Create Profile” button.

In next window, enter a profile name: e.g. „MyMillingMachine_400x250_CSMIO_IP”
Avoid spaces and special signs (an underscore is allowed). From the „Clone from” list select:

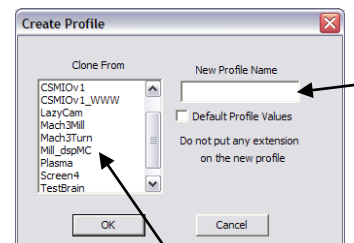

- Mach3Mill, if you are creating milling machine profile.
- Mach3Turn, if you are creating lathe profile.
- Plasma, if you are creating plasma or gas cutter profile.

Next click „OK” – profile was created. In the „Session Profile” window click now „Cancel” – we are going to create a shortcut on the desktop, it will launch the Mach3 software with our configuration. Copy the „Mach3 Loader” icon (CTRL+C, and next CTRL+V on the keyboard). Click this icon with right mouse button and select “Properties”. On “General” tab enter any name e.g. “MyMillingMachine”, go to the „Shortcut” tab and in the „Target element” enter:



C:\Mach3\Mach3.exe /p MyMillingMachine_400x250_CSMIO_IP

Type the special signs „/” and „\” carefully, in correct places. You can type any other name of course instead of "MyMillingMachine..." but it must be identical as your profile name.

After all click „OK” and now, you can launch the software using the shortcut you have just created.

10.2 The first run

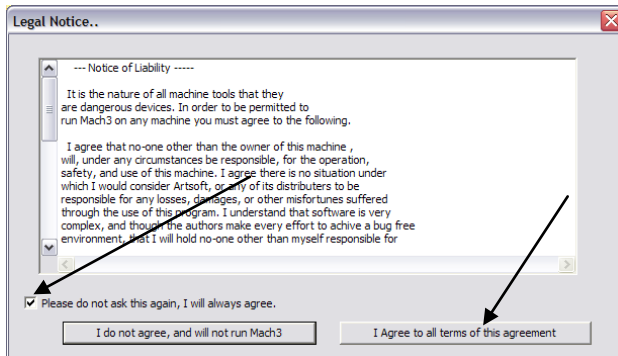

Before that, you should connect Ethernet cable of the controller to a computer or plug it into a computer network. You must switch the controller power ON at least 10 seconds earlier.

After you launch the software for the first time, you will see the window of license approval.

You should fill in the check box and agree by clicking the button as shown in the picture.

If plugin for CSMIO/IP-S was installed properly, as described in the chapter 9 - then there should this window appear:

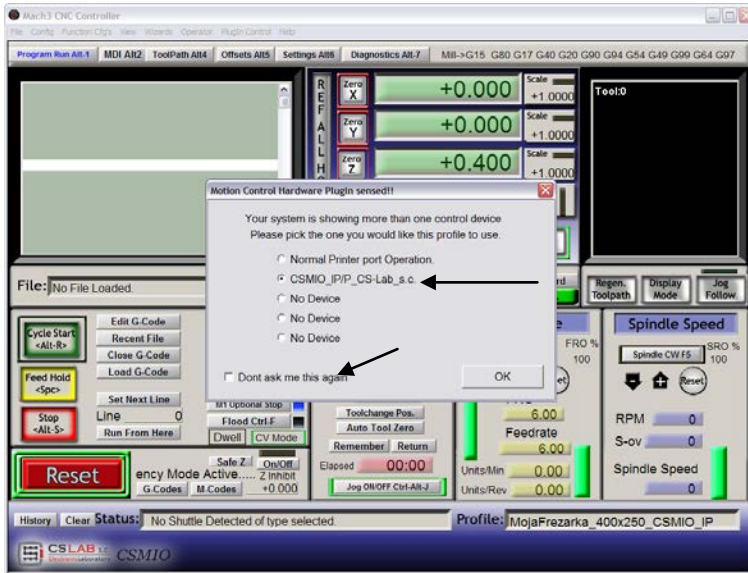

Select motion controller type – „CSMIO_IP/P” and fill in the check box: „Don’t ask me again”, so Mach3 in this configuration profile will always use CSMIO/IP-S controller. Confirm your selection with “OK”.

Before you start other parameters configuration, you can verify if communication with the controller is correct. Click on the „Plugin Control” top menu and select the „ CSMIO_IPplugin” position.

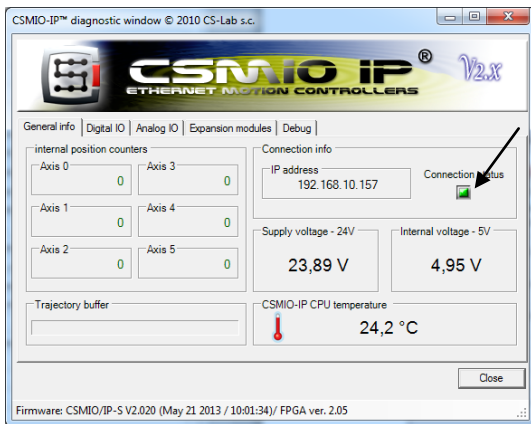

You will see CSMIO/IP diagnostic window. If the "Connection status" light is green it means that the firmware was installed correctly and communication between Mach3 software CSMIO/IP controller is also correct.

If during Mach3 software launching the „CSMIO/IP connection” window will appear and the „Connection status” light in the diagnostic window will flash red, it means that the CSMIO/IP-S was not found in the network. In that case, check some possible reasons:



- The Ethernet cable must be connected to the device before turning the power on. If it was not – quit the Mach3 software and turn the CSMIO/IP-S power off, connect the Ethernet cable, wait 10 seconds and launch the Mach3 software again.
- If CSMIO/IP-S is connected directly to PC, verify if network settings are correct – described in chapter 7. Quit Mach3 software, verify the settings and change if necessary, start the software again.
- If at least 10 seconds have not passed from turning on the device power to Mach3 launching –quit the software and launch it again.
- You can try to use a different network cable.

If these tips did not help and there is still no connection, you should contact your distributor or the CS-Lab company.



10.3 Configuration of axes used in a machine

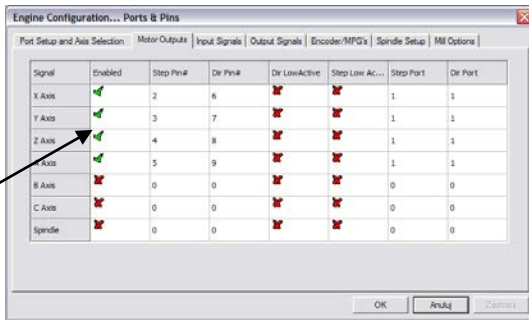

At the beginning, you should activate support of the axes you are going to use. Select the menu position „Config→Ports and Pins” and next „Motor Outputs” tab.

Select axes we are using by clicking „Enabled” - the green ticks will appear next to them. We do not activate slave axes in that window.

- Example 1: 3 axis plotter X, Y, Z.
 - Activate the X, Y, Z-axes.
- Example 2: 3 axis plotter + rotary A axis, Y-axis on two drives (slave axis).
 - Activate the X, Y, Z, A axes (the slave axis should not be activated here).

i In „Motor Outputs” tab if you use Mach3 software and CSMIO/IP controller following options are unused: Step Pin, Dir Pin, Dir Low Active (you change directions in menu „Config→Homing/Limits”), Step Port and Dir Port.

i By default axes are assigned to the following STEP/DIR channels: X→[0] / Y→[1] / etc. Pin numbers entered in Mach3, in „Port&Pins” window, „Motor Outputs” tab do not matter. To assign other STEP/DIR channels to the axes you should do it in plugin’s configuration: menu „Config→Config Plugins→CONFIG”.

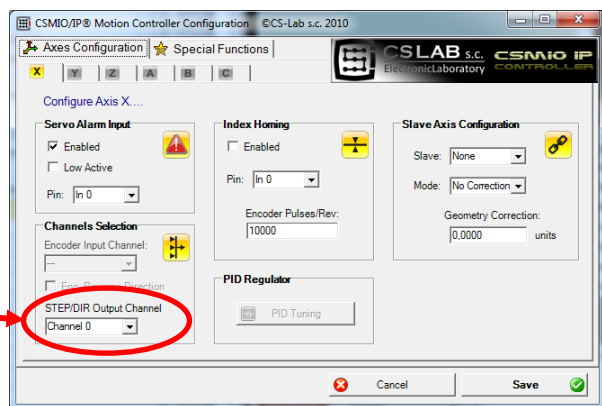



10.4 Configuration of digital input signals

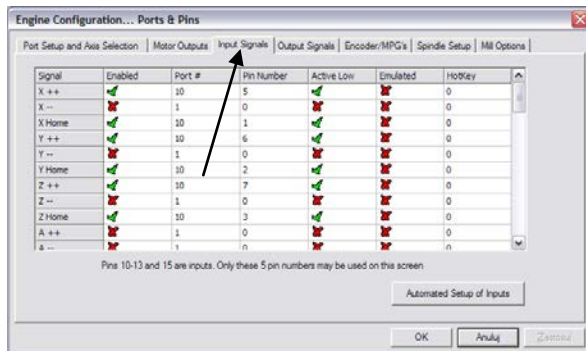

Configuration of the input signals we call from menu „Config→Ports and Pins”, by selecting „Input Signals” tab. A list of standard input signals will appear and you can assign these signals to hardware inputs of CSMIO/IP-S controller.

Columns explanation:

Column name	Description
Enabled	<ul style="list-style-type: none"> Green tick means we are using the signal. Red X cross means that we are not interested in that signal and it should not be used
Port #	Input port number – for CSMIO/IP it is always port no. 10.
Pin Number	Pin number, <u>means the CSMIO/IP input number</u> , e.g. input no. 14 of the controller we put here as a pin no. 14. <u>It does not mean a pin number on CSMIO/IP connector.</u>
Active Low	Signal polarization change, it is a selection whether the signal should be active at 0V or at 24V.
Emulated	Signal emulation with keyboard shortcut. In CSMIO/IP-S controller, only some signals may be emulated: „THC On”, „THC Up”, „THC Dn” and „Probe”.
HotKey	Keyboard shortcut for signal emulation.

Detailed description of the signals is available in ArtSoft® documentation: www.machsupport.com, below we present short description of the most important.

Signal signature	Description
X++, Y++, Z++, A++, B++, C++	Hardware signals of positive limits. A machine stops immediately when one of the signals becomes active.
X--, Y--, Z--, A--, B--, C--	Hardware signals of negative limits. A machine stops immediately when one of the signals becomes active.
X Home, Y Home, Z Home, A Home, B Home, C Home	Signals of axis homing.
INPUT1 – INPUT4	Input signals for general use. They can be used e.g. in VisualBasic® scripts.
Probe	Signals of a measurement probe, e.g. sensor of tool length measurement sensor.
Index	Index from a spindle for rotational/threading speed measurement.
Limit Ovrd	Motion forcing, if one of LIMIT signals is active. It is useful to allow for move back off the limit switch. If we are using Auto Limit Override function – this signal is useless.
EStop	Emergency stop. You should pay special attention to set this signal correctly and test how it is functioning.
THC On	For plasma cutters. During plasma cutting a machine stops automat-



	ically, when this signal becomes inactive.
THC Up	For plasma cutters. Signal of automatic torch high control, an active state causes Z-axis raising.
THC Down	For plasma cutters. Signal of automatic torch high control, an active state causes Z-axis lowering.
OEM Trig 1-15	Using these signals, you can e.g. start software with a button on a machines desktop.
JOG X++, JOG Y++, JOG Z++, JOG A++	Signals that allow for motion of each axis in manual mode (movement in the positive direction).
JOG X--, JOG Y--, JOG Z--, JOG A--	Signals that allow for motion of each axis in manual mode (movement in the negative direction).

i If you are not sure on which input in the CSMIO/IP-S is one of the signals connected, then you can open diagnostic window from the „Plugin Control/CSMIO_IP_P_plugin” menu, go to the „Digital IO” tab and in the „Digital inputs” area there is a preview of all inputs state of our controller. Then you can just e.g. pressing a limit switch manually to look at a screen, and see, which input changed its state. You can also watch the LEDs located on the controller.

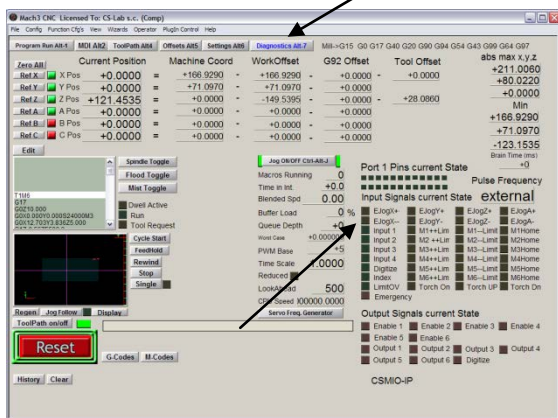
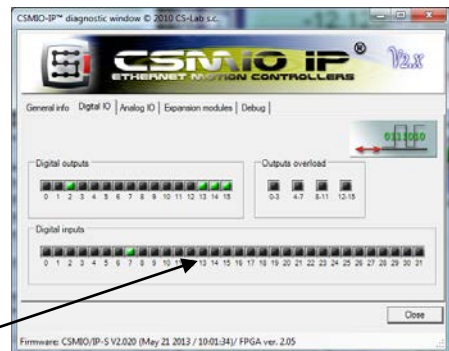

After all input signals configuration it is worth to check, whether it has been done correctly. To do so, close the configuration window, approving with „OK” and then go to the „Diagnostics” screen (top button bar in Mach3 software window).

Under the „Input Signals current State”, there are controls, which show current state of input signals of the Mach3 software. Now you can press the emergency stop button, the „Emergency” LED should start flashing. The same way you can check other signals, e.g. by pressing manually the limit and homing switches etc.

! Check carefully the E-STOP signal functioning before you continue your configuration. It is very important to have possibility to stop the machine immediately, especially during the first run and configuration!

i In the CSMIO/IP controller, there was additionally implemented fault signals support from servo drives. Details in the „Additional configuration functions” chapter.



i Since the CSMIO/IP v1.07 firmware version there is a possibility to give the same input PIN as LIMIT and HOME. You should disable the „Home Sw. Safety“ option in „General Config“ window of Mach3 software. With „Home Sw. Safety“ option disabled, the LIMIT signals are not monitored during homing.

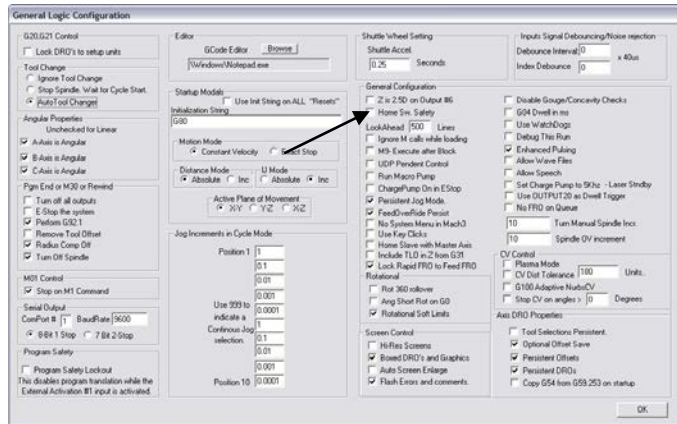

10.5 Configuration of digital output signals

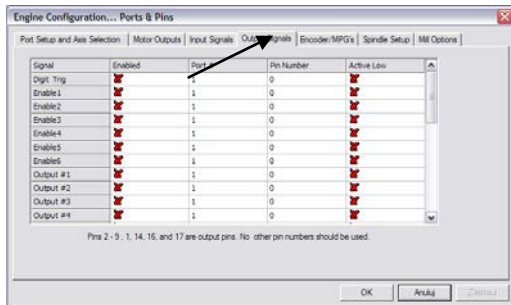

Digital outputs are used for such tasks as e.g. spindle/torch activation, activation/releasing brakes of electromagnetic motors, cooling, solenoids valves activation, etc.

The outputs configuration is almost the same as the inputs configuration.

Columns explanation:

Name of the column	Description
Enabled	<ul style="list-style-type: none"> Green tick means we use the signal. Red X cross means that we do not use the signal and that it should not be used.
Port #	Input port number – for the CSMIO/IP-S it is always port no. 10.
Pin Number	Pin number, means the CSMIO/IP-S output number, e.g. output no. 5 of the controller we put here as pin no. 5. You do not give here PIN number on CSMIO/IP connector.
Active Low	Signal polarization change, it is a selection whether the signal should be active at 0V or at 24V.



Detailed description of the signals is available in ArtSoft® documentation: www.machsupport.com, below we present short description of the most important.

Signal signature	Description
ENABLE1-6	Signals of axis enabling. Can be used e.g. as an enabling signals (Servo ON) in servo drives. For axes in use (section 10.3), the signals pass into active state after pressing RESET on Mach3 screen. If Mach goes into stop state, the signals are disabled.
OUTPUT1-20	Universal outputs. Can be used to control a spindle, cooling as well as from VisualBasic scripts level.
Current Hi/Low	Current limit output for stepper motors. If axes of a machine are in standby mode, there is no need to supply the stepper motors with full current. This signal becomes active, when axes are not moving. Current limit allow for energy consumption reducing and motors heating up – the same lengthening their life. Unfortunately, many controllers of the stepper motors do not have correct input to connect this signal.

i Again, during system startup the diagnostic window from the “PlugIn Control” menu may be helpful. In „Digital IO” tab, you can view current output signals state and assess if any problems result from some wrong configuration or from some incorrect electrical connection.

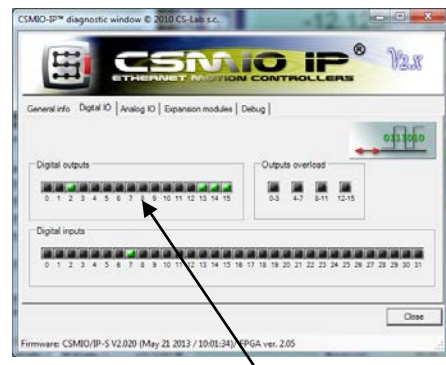



10.6 Configuration of spindle and cooling

First, you must configure output signals. For that you should select „Config/Ports and Pins” from menu and go to „Spindle setup” tab. In „Relay control” group set Mach3 output signals numbers (these are not the numbers of CSMIO/IP outputs, see previous section about output signals configuration). Here you can select the OUTPUT1-6 signals.

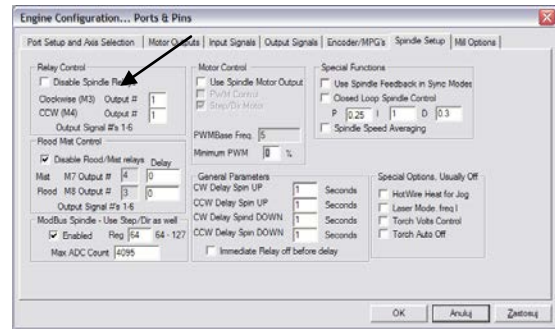

There are two options: for right revs (M3) and left revs (M4). We must uncheck „Disable Spindle Relays” box of course - that means no support for spindle activation.

In „Flood Mist Control” group placed below, we set control of cooling activation just the same way. Here you can also take the OUTPUT1-6 signals. If we want to use the control function of cooling activation, we must deselect the „Disable Flood/Mist Relays” box. There are two possible modes of cooling: water mist (M7) and water stream (M8). For each mode, we give the right output signal. You can also give the same signal for both modes, so then it will be activated with both the M7 and M8 command from the G-Code. Additionally in the „Delay” area, you can also set the delay you want after cooling activation before machining begins.

Time delay for spindle switching on and off is also an important parameter. In particular, the high-revs spindles need a little time after activation to speed up to the required speed. In the „General Parameters” group, we can define independently an acceleration and deceleration time for right and left revs.

CW Delay Spin UP	Acceleration time for right revs
CCW Delay Spin UP	Acceleration time for left revs
CW Delay Spin DOWN	Deceleration time for right revs
CCW Delay Spin DOWN	Deceleration time for left revs

10.6.1 Analog output configuration

The last things we configure in the „Ports and Pins” window are parameters related to the control of a rotational speed through the digital input of CSMIO/IP-S. In the „ModBus Spindle – use step/dir as well” group select the „Enabled” area, in the „Reg” box enter value of 64, and in the „Max ADC count” – 4095. Now you can close the „Port and Pins” configuration window, click „Apply” and „OK.”

For correct control of the revs, you have to specify what range of the revs our spindle has (including the inverter settings and eventual pulleys). Select the „Config/Spindle Pulleys...” menu position. If we use one ratio then enter „Min” and „Max” revs. Approve with „OK.”

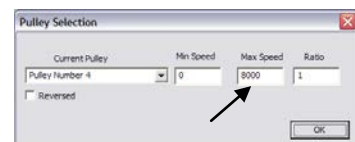



Last thing related to the revs control is a choice of analog output, which will be used.

- select from the menu „Config/Config PlugIns”
- click „CONFIG” next to the „CSMIO/IP”
- go to „Spindle” tab, in the „Spindle DAC” group
- select „Enable”
- on the „Select Analog Output” list select analog output.



i Again, during the startup the diagnostic window may be helpful. In the „Analog IO” tab, you can preview current voltages on analog inputs and outputs. When we configure the spindle, then in a MDI tab you can enter e.g. M3 (enter), S2000 (enter). It should cause spindle activation (right revs) and setting the revs on: 2000 rpm. In the diagnostic window, you can see digital outputs and voltage on analog output activated. Additionally the icon informs us which analog input is configured to control a spindle.

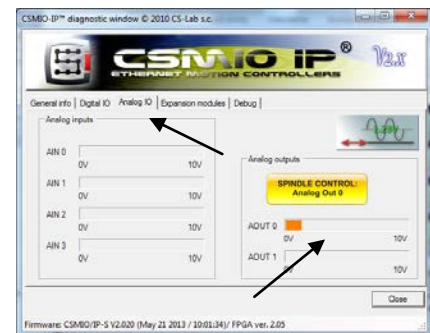

! Check carefully inverter settings before spindle activation, incorrect configuration may cause permanent damage of the spindle, which is not covered by warranty. Pay attention if the left/right revs are activated correctly – machining with incorrect revs direction may cause damage of a tool or a work piece.

10.6.2 Problematic PWM Control function

A frequent reason of problems with analog inputs is „PWM Control” option set in Mach3. On first sight, sometimes we do not see this position is marked, especially when „Use Spindle Motor Output” position is not active. Below you can see correct and incorrect settings.

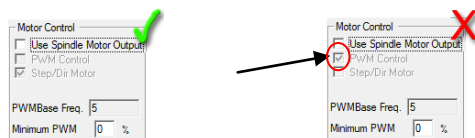

If „PWM Control” is check-marked but inactive you must first mark “Use Spindle Motor Output”, then click „Step/Dir Motor”, and again uncheck the „Use Spindle Motor Output”. Selecting „Step/Dir Motor” in this place does not mean that spindle will be controlled by STEP/DIR signals. Configuration of a spindle as an axis you will perform in plugin. It is described later in this guide, chapter: “Additional configuration functions in plugin’s window”.

The „PWM Control” option should be unchecked because it is incompatible with CSMIO/IP and leads to errors during spindle revs control.



10.7 Configuration of resolution, speed and acceleration

Before we start working, it is absolutely necessary to set resolution (so-called scaling) of axes correctly and to set their max. speed and acceleration -in the Mach3 software - „Config/Motor Tuning” menu. In the window, first select an axis you want to configure, next enter parameters and click „SAVE AXIS SETTINGS”. Now you can select and set the next axis.

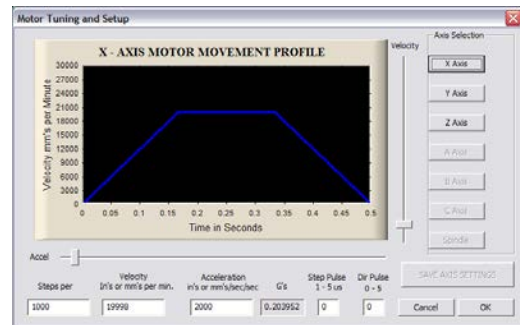

If we forget to click on „SAVE AXIS SETTINGS” all the changes will not be saved.

For correct axis scaling you must know how many steps falls on a unit (millimeter, inch or degree). To understand how to calculate it, look at the example below:

- A linear axis is powered by servomotor with 10000 rpm encoder.
- A servo drive is configured without a multiplier and a pulley, so the 10000 STEP pulses cause a 1 rev of the motor.
- To transfer the drive there was a ball screw used - pitch 10mm.
- No ratio between motor and a screw.

$$\text{StepsPer} = \frac{\text{steps number per motor rev}}{\text{feed per motor rev}}$$

So there are 10000 pulses per motor rev and 10mm feed rate. Dividing these values 10000p/10mm we get 1000p/mm value, which we enter into „Steps Per” box in configuration window.

In „Velocity” area, we set an axis speed. If we are using millimeters as an unit then speed is shown in mm/min, if we use degrees - degree/min, if inch - inch/min. Max. speed value is very individual and depends on what motors, drives etc. were used. For the first tests, we recommend to enter relatively small value e.g. 2000mm/min, in case something went wrong, we will always have enough time to press an emergency button E-STOP.

In „Acceleration” area, we define acceleration for an axis. At the beginning, we recommend to enter something about 400mm/s². Later you can set this parameter experimentally by assessing the machine working.



Remember to click „SAVE AXIS SETTINGS” for each axis after finished edition. Perform the configuration as follows:

Open „Motor Tuning” window → Select axis („Axis Selection”) → Enter the parameters → „SAVE AXIS SETTINGS” → Select the next axis → etc. Click „OK” and close the window.



„Step pulse” and „dir pulse” areas do not matter for CSMIO/IP. They are used to control via LPT port and they define width and STEP/DIR pulse time. The CSMIO/IP-S controller provides the signal with the 50% duty cycle, which is the most optimal variant.



-  Due to connection of STEP/DIR signals to the drive (both servo and stepper drives) pay attention which STEP edge is active.

The example:

While connecting the controller– e.g. for the M542 stepper motor you should connect the PUL+ signal to STEP+ and PUL- output to STEP signal of CSMIO/IP. This way – switching on the optocoupler in the M542 will be followed at proper edge of the CSMIO/IP-S STEP signal. If the connection is incorrect, 1 step will be lost during every direction change. After a long work, it may accumulate large position error.

-  If needed (e.g. if there are position errors) STEP signal polarization may be changed by software, individually for each axis It is set in menu „Config→Ports and Pins“, „Motor Outputs“ tab, „Step Low Active“ column.

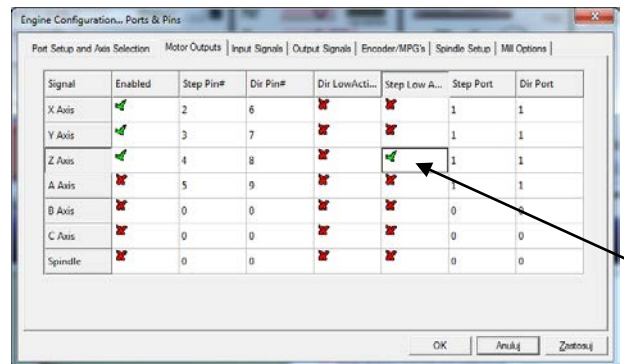



10.8 Configuration of directions, homing and software limits.

When axes are scaled and their speed is configured, it is important to set directions correctly. Useful function is possibility to indicate software limits - the machine working range.

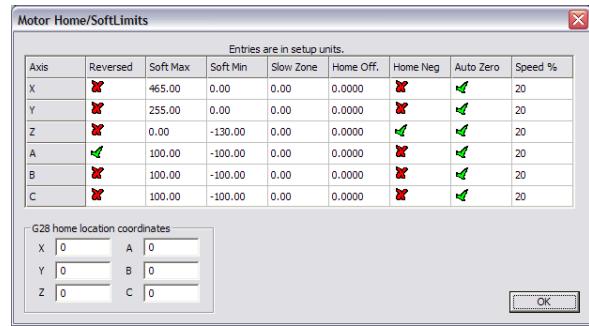

Select in the menu „Config→Homing/Limits” position. In the window, we have configuration parameters for each axis:

Column name	Description
Reversed	Switching this field, you change direction of an axis motion.
Soft Max	Maximum range of motion in positive direction
Soft Min	Maximum range of motion in negative direction
Slow Zone	In the CSMIO/IP-S, this field is not used. In LPT, it is used to define a section for braking near to the end of working range. CSMIO/IP-S controller automatically calculates the braking distance including acceleration defined for the axis. The best way is to enter 0 in this box.
Home Off.	Starting v1.07 version firmware - in this field we can define a distance of going off from HOME sensor after homing. If we enter e.g. 5mm, then the controller will home the axis on a HOME sensor and after that, it will go off with 5mm and reset axis position. You can also enter a negative value - in some cases it is very useful.
Home Neg	As a standard an axis homing goes into negative direction. However, we usually home the Z-axis upwards and the down motion is a negative direction. Therefore, we have to do Z-axis homing in a positive direction. Home Neg is to select homing direction.
Auto Zero	This area is not used on the CSMIO/IP-S controller. After homing – the axis is always zeroed.
Speed %	Homing speed. It is shown as a percent of maximum speed defined in „Motor Tuning”. For the first tests we recommend 10%.

! Attention! – you can enable and disable software limits. If they are enable, the software cannot control an overrun of working area. The only protections are hardware LIMIT switches.

i When software limits option is active („Soft Limit” on a Mach3 main screen), the CSMIO/IP-S controller does not let for any move if axes of a machine are not homed. Current status of the function is shown by the green light around „Soft Limit” button.

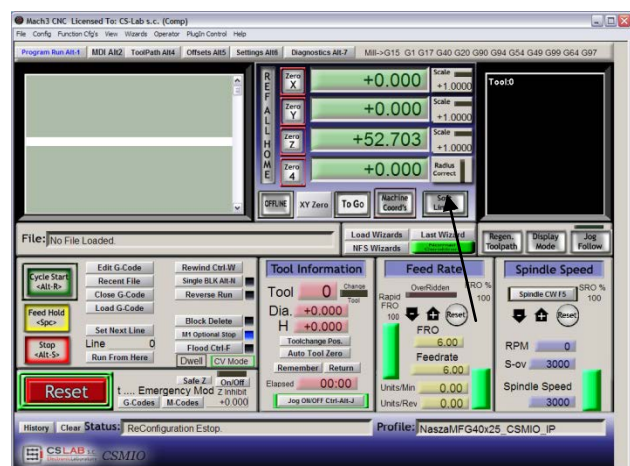



10.9 Configuration functions in a plug-in window

The configuration window of plugin is activated by „Config→Config Plugins” menu position, click „CONFIG” next to the CSMIO/IP name.

If there were different types of CSMIO/IP controllers installed then click “Config” next to the controller that will be used.

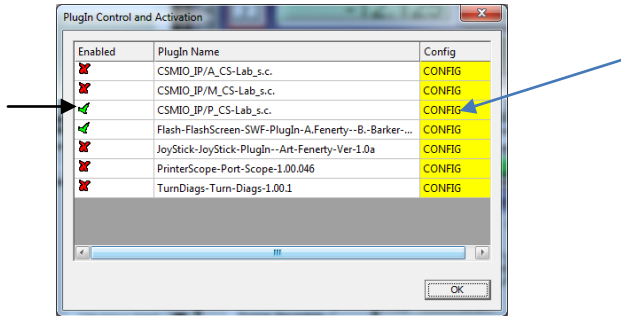

10.9.1 Axes special functions

Axis configuration is divided into the following groups:

- Servo Alarm Input
- Channels Selection
- Index Homing
- PID Regulator
- Slave Axis Configuration

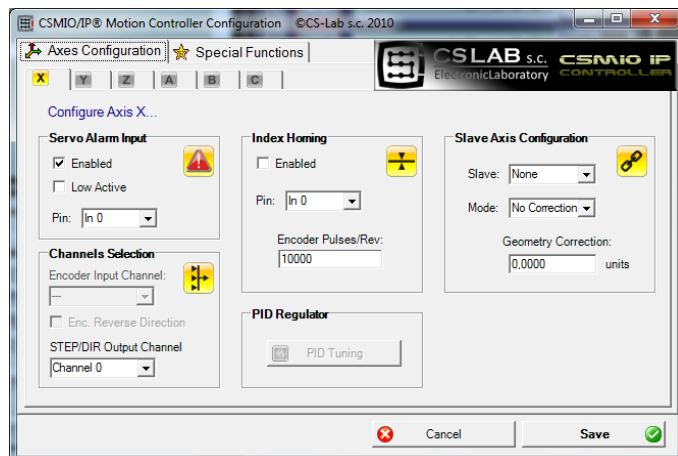

10.9.1.1 Servo Alarm Input - an alarm input in servo drives

The CSMIO/IP- controller has a possibility of autonomous reaction to fault signals from servo drives. A drive may generate a fault e.g. in case of overload. If the fault signal appears the CSMIO/IP stops all axis within 0,1ms. It is worth to configure in servo drives a dynamic brake function, which will reduce distance that an axis moves with the power of inertia.

Enabled	Function enable/disable
Low Active	Active signal in a Low state
Pin	Input number on CSMIO/IP-S controller

10.9.1.2 STEP/DIR Channels Selection

CSMIO/IP-S controller has 6 STEP/DIR output channels. For X axis, by default, there is assigned 0 channel, for Y – 1 channel, Z – 2 channel... etc.

For each axis there can be any channel assigned. We made the choice from the „STEP/DIR Output Channel” list.



10.9.1.3 Index Homing

If we connected INDEX signal from servo drive to the controller, then we can enable precise homing function with INDEX signal use. It greatly improves homing repeatability, even when homing switches have quite large spread.

Enabled	<i>Turning function on and off</i>
Pin	<i>CSMIO/IP input number</i>
Encoder Pulses/Rev	<i>Pulses number per encoder rev (with all edges)</i>

10.9.1.4 A PID controller

This group is only for CSMIO/IP-A controller. In IP-S model is not active.

10.9.1.5 Slave Axis configuration.

In large machines there are often two motors used to support single axis – one on each side. Even though in Mach3 software - „Config” menu there is a position to configure slave axes, we provide here autonomous support for the function, to increase reliability level.

Some users implement a slave axis by linking the STEP/Dir signals of two drives and connecting them to one channel of a controller or they use the slave axis function, which is available in some servo drives.

The slave axis implementation through the CSMIO/IP-S has one significant advantage –function of machine geometry correction available (e.g. gantry perpendicularity). It is more specifically described in the addition „Slave axis configuration example”. In brief – for each X, Y, Z-axis you can define one slave axis. The slave axes can be A, B and C.

Configuration parameters:

Slave	<i>Axis selection, which one will be slave for the currently selected one</i>
Mode	<i>Slave axis working mode</i>
Geometry Correction	<i>Geometry correction value of a machine tool</i>

Slave axis working mode:

No Correction	<i>Mode without correction – Master and Slave axes work just like “glued” together.</i>
Read Difference	<i>Homing position difference readout between Master and Slave axes. After homing, the value will be entered in „Geometry Correction” area.</i>
Sl. Correction	<i>After homing, Slave axis is “freed” for a while and geometry correction motion is done. It allows for e.g. perpendicularity settings in gentry machines.</i>



In „A” addition you can find slave axis configuration example described.

If you want to use slave axis function – read the addition „Slave axis configuration example”.



CS-Lab Company has made every effort to ensure reliability of the CSMIO/IP-S controller. However, the company does not take any responsibility for any mechanics damage because of wrong configuration and any eventual failure or errors of CSMIO/IP-S controller.



We strongly discourage using slave axis function with stepper motors. Stepper motors don't have feedback and it's easy to damage mechanics in a machine, e.g. when one of the motors brakes and the other one still works.



10.9.2 Spindle configuration

CSMIO/IP controller has many additional functions according to a spindle. The options were divided into following groups:

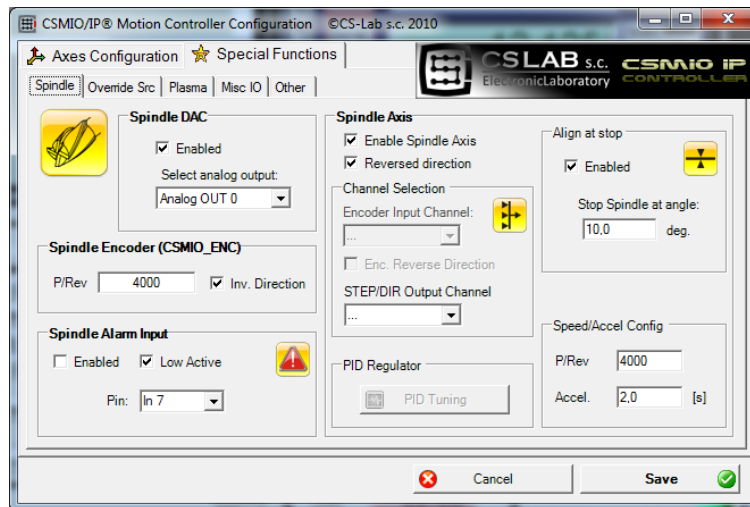

Spindle DAC	Selection of analog output for spindle revs control
Spindle Encoder (CSMIO_ENC)	CSMIO-ENC module configuration
Spindle Alarm Input	Spindle drive alarm signal input configuration
Spindle Axis	Spindle operation through axis channel (STEP/DIR) options

10.9.2.1 Spindle DAC – revs control output

Enabled	Enabling revs control on analog 0-10V output
Select Analog Output	Analog output selection

10.9.2.2 Spindle Encoder – spindle encoder module

P/Rev	Pulses number per spindle rev (with all edges)
Inv. Direction	Analog output number selection

10.9.2.3 Spindle Axis – axis channel spindle control

Enable Spindle Axis	Function enable
Reversed Direction	Revs direction change
Channel Selection	STEP/DIR output channel selection for spindle operation (it's important to remember that for “common” axis operation there are only 5 channels left so it's impossible to use 6 axes)
PID Regulator	Only for CSMIO/IP-A – PID regulator tuning
Align at stop	Automatic spindle setting in demanded angle always after turning off. This function is especially useful when spindle axis, for tool change, must be set in a defined position. „Enabled” activates the function and below you can enter the angle for spindle setting.
Speed/Accel Config	Configuration of pulses per spindle drive motor rev and acceleration. The acceleration value entered here is a time in which the spindle gets max. revs (defined in Spindle Pulleys).



10.9.3 Override sources – feed speed and spindle revs corrections source selection

Mach3 software allows for feed speed and spindle speed change during work. As a standard, it is adjusted using two sliders and a main screen. If machine tool were equipped with additional panel with buttons, it would be easier to adjust the speed using knobs placed on it. With CSMIO/IP-S, we can also control feed speed and spindle revs using potentiometers connected to analog inputs.

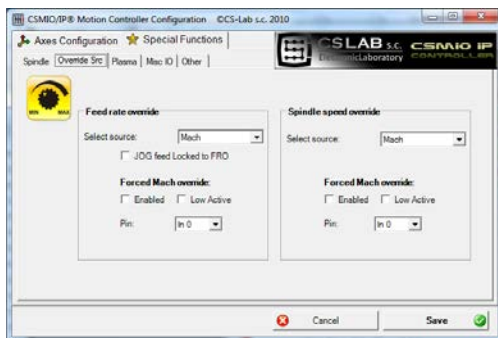
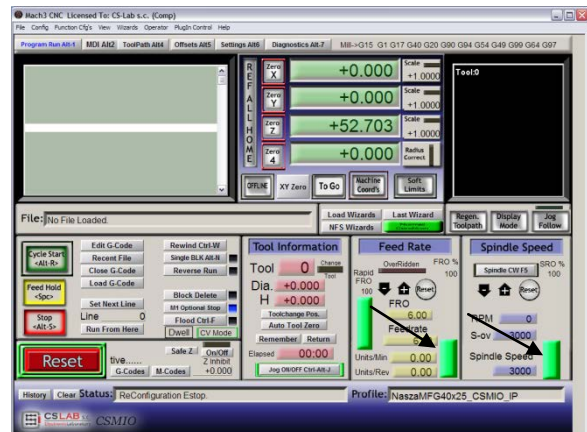

In „Override sources” tab you can set whether the speed adjustment should be done through Mach3 screen, analog inputs or additional MPG encoder axes, etc. „Feed rate override” applies to feed speed and „Spindle speed override” to spindle revs.

The following options are available:

Mach	Regulation via PC (slider on a Mach’s screen)
CSMIO/IP AIN 0/1/2/3	Analog inputs of CSMIO/IP controller
MPG AIN 0/1	Analog inputs of CSMIO-MPG module
MPG AXIS 4/5/6	4, 5 or 6 axis of MPG encoder jog (pendant)

For both feed speed and spindle revs speed control we can define digital input of CSMIO/IP, which will force control from Mach3 screen – „Forced Mach override”. Thanks to this, you can easily and quickly switch the source of speed defining– e.g. using a switcher placed on a machine’s panel.



10.9.4 Plasma – additional functions for plasma cutters

In current software version, we have one option available – torch high control via analog input.

Configuration is only about to enable the function, select polarization, and to select analog input.

The function, with normal polarization, works the way that for 0V on analog input there is correction entered in THC min, and for 10V - THC max configured in Mach3 screen. With reversed polarization – for 0V there is THC max, and for 10V - THC min.

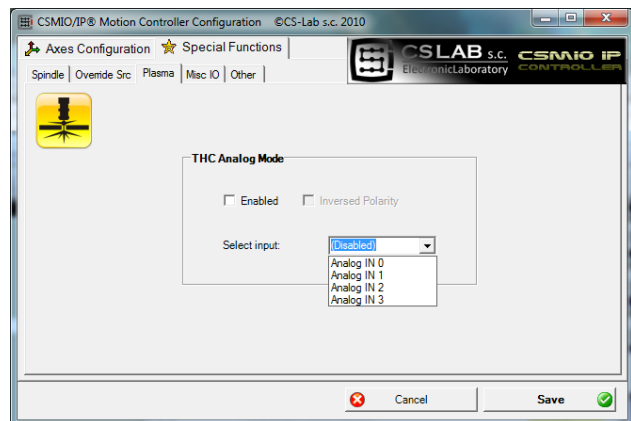

Enabled	Function enable/disable
Inversed Polarity	Polarization reverse
Select input	Selection of analog input for torch high control



Attention! – Plasma generators are dangerous because of high voltage on electrodes. To analog inputs of CSMIO/IP you should connect only galvanically isolated signal and well filtered (it is good to place RC filter in the connector). Incompetent connection of signals of a plasma generator to CSMIO/IP controller may cause its damage.

10.9.5 Misc IO – Special functions related to I/O

10.9.5.1 Servo drive RESET

Any CSMIO/IP controller output can be assigned as a RESET signal for servo drives. On the output, there will be a short pulse every time when in Mach3 the RESET function will be called.

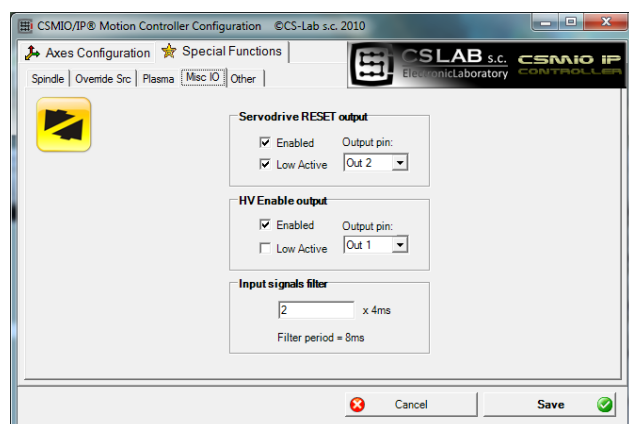

10.9.5.2 HV Enable

In this place you can – for any CSMIO/IP controller output – assign a function of main voltage activation (e.g. for servo drives). In many alarm situations like e.g. E-STOP signal activation, additionally main supply disconnection it may increase security level.

Output defined as „HV Enable” will be active during normal work of CSMIO/IP controller, in case of any alarm situations such as limit switch or E-Stop touch, the signal will become inactive.



10.9.5.3 Input signals filter

Sometimes happens that on a large machine tool, electromagnetic noises level is so high that standard hardware limits, mounted in CSMIO/IP are not enough and so there appear false signals e.g. LIMIT, E-STOP etc., causing machine work brake.

In such situations, the input signals filtering function may be very helpful. We define here filtering time. I do not recommend using high values because of the fact that later there may some delays occur in reaction to digital inputs.

If values of 1-15 (4ms – 60ms) do not solve the problem, then a hardware and machine tool wiring quality may be the cause.



Long filtration time may delay reaction on alarm signals even up to 0,4s. The delay will also be visible during HOMING or tool measurement (PROBING), causing that machine's axis will go through a longer distance after sensor activation.

As mentioned above, there is rather no sense to give filtration time higher than 60ms, and so small delays are practically unnoticeable.

10.9.6 Other plugin functions

10.9.6.1 MPG multipliers

If you use CSMIO-MPG module and an external jog encoder (handwheel), you can switch the multiplier between three values. In this place, we can select what values it will be. Lower range gives better precision and safeness – because in this case turning the encoder we will not speed up the machine to high speeds.

Higher range will be better for large-size plotters to move the axes quickly over long distances.

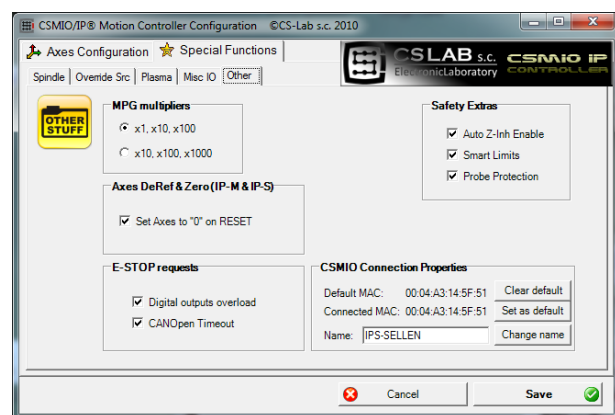

10.9.6.2 Axes DeRef & Zero – axis reset after emergency stop

CSMIO/IP-S and CSMIO/IP-M controllers reset axis position by default and require reference after emergency stop. This solution is safe because often, after emergency stop, real machine's axis position is unknown. Position and reference reset gives a clear information to operator to do homing again, to check material position etc. However sometimes automatic reset may be burdensome or in some cases even not recommended. Deselecting „Set Axes to '0' on RESET option, we can disable automatic position resetting.

10.9.6.3 E-STOP requests – alarm events

In this place, we can disable machine stopping in following situations:

- Digital outputs overload
- CANOpen Timeout

Deselecting this option causes that such situation will not cause that machine stops.



10.9.6.4 Safety Extras

In CSMIO/IP firmware few additional functions were implemented, which increase safety and comfort of work.

Auto Z-Inh Enable	Automatic Z-axis move limitation. Enables protection against worktable of a machine damage. More details in chapter 14.1 – Automatic Tool Length Measurement.
Smart Limits	Movement blocking when hardware limit signal is active. It works the way that e.g. when X++ signal is active, then we can move X-axis only in „-„ direction.
Probe protection	Tool length sensor protection. When Probe signal is active then Z-axis manual jog in „-„ (down) direction is blocked. If Probe signal goes active during treatment, a machine will be stopped just like in situation when E-Stop is pressed on.

10.9.6.5 CSMIO Connection Properties – additional connection options

Default MAC	Default MAC address for a connection. It is useful if in our local network, there are few CSMIO/IP controllers and we do not want to select a controller we want to connect with at every Mach3 start. It is set by „Set as Default” button and reset using „Clear Default”.
Connected MAC	Information about MAC address of currently connected CSMIO/IP controller.
Name	Currently connected controller name. You can name it by yourself. The name will also be displayed in controller's selection window if in local network there is more than one CSMIO/IP controller. To give your name you must enter it and click „Change Name”.
Clear Default	Default MAC address deletion.
Set as Default	Default MAC address setting.
Change Name	Private name setting for connected CSMIO/IP controller. It can be any name. However, it cannot contain spaces or special characters - e.g. „Lathe01”.



10.10 Selection of inch/mm units

Selection of units by which the axes in „Motor Tuning” are scaled is set in „Config→Select Native Units” menu position. Select unit in the window and close „OK”. Selection of units for a treatment is done by G20 (inch) and G21 (mm) commands.



10.11 Some parameters in the General Config window.

In the „Config→General Config” menu, you find basic configuration parameters of Mach3. Many of them do not need any modifications, but it is worth to change some of them. In the picture below, you can see a table with the most important parameters and a short description of each one.

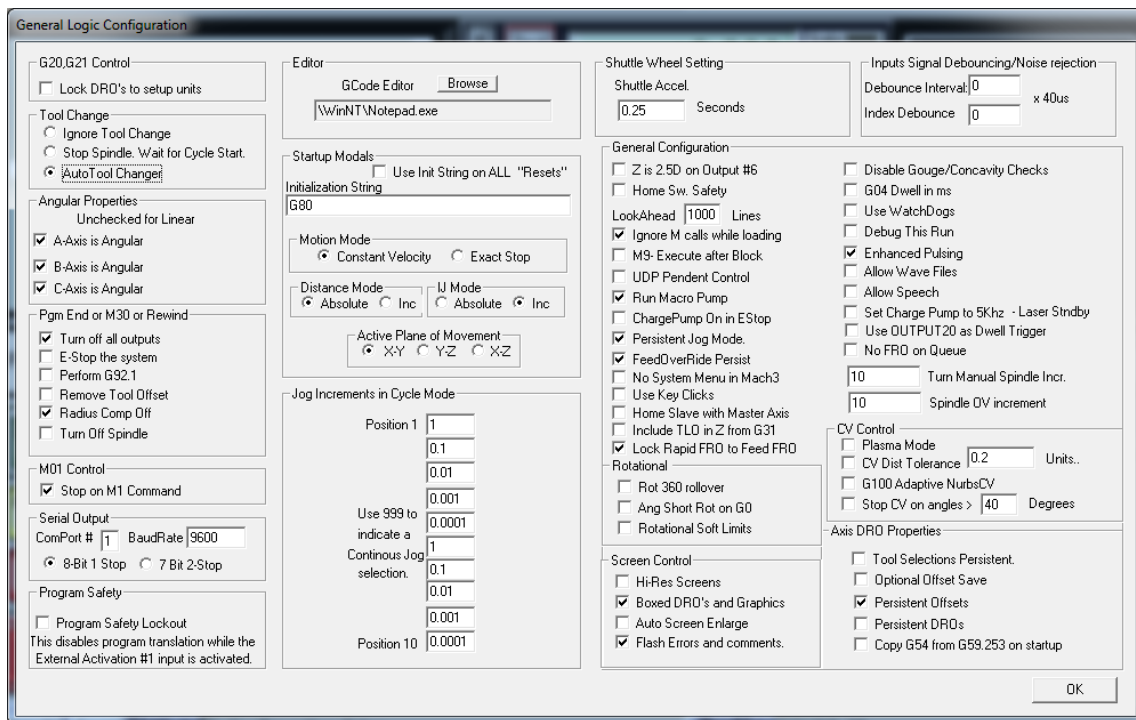

Parameter/group name	Description
Tool Change	Configuration of an automatic tool changer. An important issue: even if we do not have an automatic tool changer but we use a tool measurement sensor - the Auto Tool Changer should be selected. Otherwise, Mach3 will not take tool length into account.
Angular Properties	Checking the box, we select, if A, B, or C axis works as angular. Unchecked box means that the axis works as linear.
Pgm end or M30 or Rewind	It is about behavior at the end of a program, M30 or REWIND command.
Motion Mode	Motion mode selection: Constant Velocity or stop at every trajectory section (Exact Stop). The Exact Stop mode may be more precise in some cases but much more slowly. Constant Velocity mode is used in 99% of cases.
IJ Mode	Data format for circular interpolation. Usually "Inc" should be selected. After loading the trajectory, generated with CAM software, if there are problems with circular interpolation (like large circles in a 3D preview), you can try to switch to „Absolute” and then load G-Code again.



Active Plane of Movement	Default plane for circular interpolation G2/G3. Usually X-Y for milling machines, X-Z for lathes.
Jog increments In cycle mode	Default feed values for stepper work.
Home Sw. Safety	Homing mode. When this mode is disabled, the homing process is less restrictive. It allows for e.g. homing start when an axis is already on the HOME switch. When homing also LIMIT signals are not taken into account. With this option selected so-called safe homing is performed, LIMITs are all the time taken into account, also you cannot start homing when an axis is on a HOME sensor.
Ignore M calls while loading	Macros ignoring („M” commands) from g-code file when loading. This option should be <u>activated</u> . Without it when file is loading, a machine may start performing macros by itself.
Look Ahead	Mach3 performs dynamic trajectory analysis in advance, to adjust motion speed in every trajectory place. In the „Look Ahead” area, you can enter number of G-Code lines, which should be analyzed in advance. Usually 1000 value is enough to get motion smoothness even when dynamic and fast softwares are made.
Run Macro Pump	When this option is selected in a catalogue with VisualBasic scripts you can create a macropump.m1s file, it contains macro, which will be called cyclically several times per second.
Home slave with master axis	The intention of Mach3 authors is an option, which enable/disable slave axis and master axis homing together. In CSMIO/IP-S controller, a slave axis is always homed with master axis.
G04 Dwell in ms	With this option selected a delay parameter for G04 is counted in milliseconds. It is useful when you need precise, short time delay e.g. in plasma cutters.
Use watchdogs	Do not use – this function should theoretically „watch” various modules of the software and in case it should switch an emergency STOP. In practice, it does not work properly and may cause problems. In CSMIO/IP-S software, there are special algorithms, which autonomously monitor communication and whole control system work.
CV Control	Parameters for a Constant Velocity work mode. By default, all fields should be unselected. However sometimes CV settings modification is necessary. E.g. if machine acceleration is low and treatment goes with high speeds then CV mode may cause that path corners will be rounded. We can set CV mode toleration by selecting „CV Dist Tolerance” option and entering max. deviation from demanded shape.
Rotational	Parameters in this group relate to angular axes (rotary). „Rot 360 rollover” determines if there should be rollover after crossing 360 degrees. „Ang short rot. On G0” causes that at inverted G0 move, a rev may be shortened. So when an axis has at the moment e.g. 320° and should go to 0°, it will not go back with 320° but it go right with 40°. „Rotational soft limit” parameter determines if for rotary axes soft limit switches should be taken into account.
Enhanced pulsing	This parameter does not matter with CSMIO/IP-S.
Screen control	In this group, selection of „Hi-Res screens” and „Auto screen enlarge” parameters causes Mach3 screen enlarges to fit its size to screen resolution. However very often an interface is in effect disproportionately stretched and it is better to disable the functions mentioned above.



11. First tests

11.1 Checking the input signals

Before starting the tests in motion, you should first verify the main input signals, such as:

- Homing sensors – HOME
- Limit switches – LIMIT
- Emergency stop – ESTOP

After running Mach3, go to „Diagnostics” tab.

In „Input signals current state” area there are shown light indicators of the input signals. During the test, any of axes should not be on a limit switch or homing sensor. You should

manually, sequentially activate the HOME sensors and verify if correct indicators light up. There are axes at the input signals indicators marked as M1, M2, M3, M4, M5, M6 what corresponds in order to X, Y, Z, A, B, C. After HOME switches verifying you should check LIMIT switches. Again - manually activate the LIMITs on each axis and check on a screen, if correct indicators light up. If the light indicators or indicator light up constantly and they turn off after manual LIMIT switch deactivation - it means wrong polarization – you must change configuration in „Ports and pins” window (see previous sections).

If on all axes the HOME and LIMIT sensors work fine, it is time to verify an emergency stop signal (here Emergency) again. After the E-Stop pressing – the indicator should flash red light. When you release it - it should turn off.

If everything works correctly, press RESET on the screen and go to the next section.

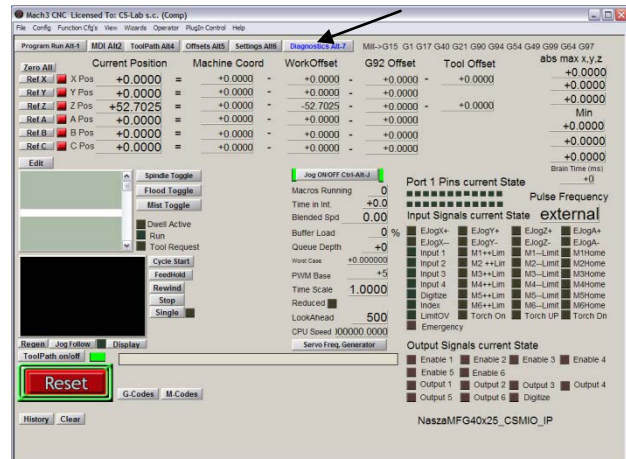



i If there is no response for any signals, you should check if software communicates with the CSMIO/IP-S controller correctly. In the diagnostics window (in „PlugIn Control→CSMIO_IP_Plugin” menu) you can check the connection status. If the control light is red, you can try to quit and run Mach3 again. If it does not help see again the sections about configuration and installation.





11.2 Verification of axes scaling and motion directions

First motion control should be made at low speed. After pressing Tab key on a keyboard – manual feed rate panel should open. In „Slow Jog Rate” enter e.g. 10%. It means that the motion will have 10% of maximum speed, defined in Motor Tuning.

SoftLimit switches should be disabled for these tests. Find the  button on Mach3 main screen – if there is a green light around it, then click this button to switch it off. If necessary press  on the main screen, Mach3 software will be in standby mode. There should be green light around the button.

You can control XY-axes by arrow keys on a keyboard, Z-axis by „Page Down” and „Page Up”. You can also use the buttons from manual feed rate window.

You should check each axis if:

- Motion direction is changing. If not, it may mean incorrect connection of DIR Signal to a drive.
- Directions are not changed. If so, you should change an axis direction in „Config→Homing/Limits” menu.



When all axes have their motion directions configured correctly – you can specify homing directions (sides). For 3-axis machine XYZ - most common configuration is homing of XY-axes in negative direction and Z- axis in positive direction. In „Config/Home/Limits” for Z axis there should be „Home Neg” selected.

Before further tests, you should check axes scaling. The best is to use dial gauge or other precise measurement tool.

In manual feed rate panel set the Jog Mode and 1mm step size. „Slow Jog Rate” does not apply to motion in positional mode (step motion) so speed is set on the main screen in „Feedrate” area. For this test, you should enter low value e.g. 100mm/min. Now, after pressing e.g. right arrow on the keyboard the X-axis goes 1mm right. You should go this way at least 10mm (each axis), verifying with dial gauge the distance actually made by the axis. The dial gauge should be reset after 1mm. If you see clear difference between the positions (requested and actual), it means that that the „Steps Per” parameter in the Motor Tuning window is set incorrectly. You should go back to the sections about configuration and verify your settings.

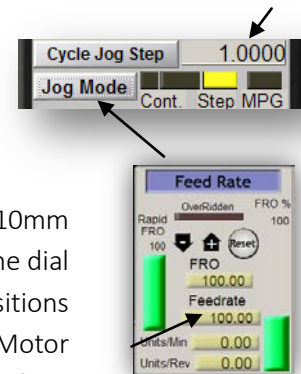

Always approve your settings on Mach screen by pressing ENTER. Otherwise, the value will not be saved.



11.3 HOMING and software limit switches test

11.3.1 First homing

When axes are scaled correctly and motion directions are correct – it is time for first homing. During normal work, most comfortable is to use a button for all axes homing („Ref All Home” on the main screen). During the tests, it is better to home the axes individually from the Mach Diagnostic screen.

On the Diagnostic screen of Mach3 you will see group of buttons for each axis homing. Before you press one, be prepared for emergency stop by EStop pressing or  on Mach screen.

Every time you press Ref... verify homing of each axis used. After correct homing – the light indicator next to the button should light green. If motion when homing is wrong, you can change the configuration in „Config→Homing/Limits”.





 If axes homing is correct, you can experiment with increasing homing speed in „Config→Homing/Limits”.



11.3.2 SoftLimit switches

If axes homing is correct then you can set, switch and check software limit switches. Click on „Jog Mode” in the manual feed rate panel and set „Cont.”. „Slow Jog Rate” set on e.g. 40%. It is worth to turn on preview of machine directions by pressing  on the Mach’s main screen. Then, in manual mode go e.g. with X-axis- on 5mm before hardware switch limit and write down on paper - the X coordinate from the screen. Repeat this action for all axes.

Open „Config→Homing/Limits” window and enter correct values into SoftMax and SoftMin. For X and Y axes it is usually SoftMin=0. You should remember that Z-axis usually works in negative direction, so the SoftMax will be equal to zero, and min. limitation enter in SoftMin.

Close „Homing/Limits”, press  and run homing again. Click on , to see the green light around. You can try and go each axis to reach coordinates that are specified in the SoftMax/SoftMin. The machine should smoothly brake and should not cross any limits of a working area.

After test is successfully finished you can turn the coordinates off by pressing .

 After some parameters change – the controller may automatically go into emergency stop mode, it is absolutely normal. In that case, you should press  and run all axes homing by pressing „Ref All Home” on the Mach’s main screen.



11.4 Test of spindle and cooling.

At this stage, almost all major elements of the system were set and a machine is almost ready to work. One important issue left – spindle test. Treatment with non-rotating spindle is generally not a good idea.

Mach should be in active mode. The quickest way to test the spindle is MDI mode. In the top bar press MDI. This mode lets you to enter G-Code commands manually:

- Enter S command, with requested spindle revs e.g. „S2000” – that is 2000 rpm speed. Approve with <enter>.
- Enter M3 command (right revs) and approve with <enter>. The spindle should start rotate right with requested speed.
- Enter M5 command (stopping) and approve with <enter>. The spindle should stop.
- Enter M4 command (left revs) and approve with <enter>. The spindle should start rotate left with requested speed.
- Stop with M5 command.
- Turn on cooling with M7, turn off - M30.
- Turn on cooling M8, turn off - M30.

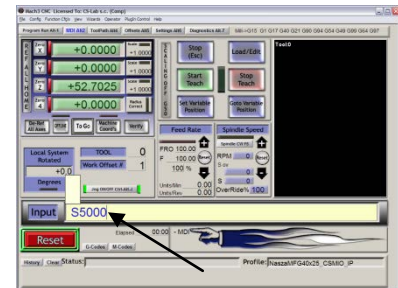

It is good to check various revs values and revs change from maximal revs to very low. If you do not use a braking resistor at inverter it may turn out that, when braking at high revs speed – the inverter will report an error. Then you have to get yourself a resistor or lengthen the braking time.

In case of any problems, check again configuration settings and eventually the inverter settings. Usually the inverters have various control modes. Without proper configuration, the inverter will not respond to outside signals.



Before spindle activation make sure if there is no loose collet. When braking at high revs speed the tightening nut may unscrew and rotating collet may cause injury risk.



12. Sample treatment step by step

To look closer at rules of using a machine equipped with CSMIO/IP-S control system – here is an example of a simple work.

An example includes area planning and logo milling in 30.6x30.6x48mm size cube made of hard aluminum alloy.

Project design and G-Code file generating will be done with popular software - ArtCam®. Logo file has AI format, which is very good for data transmission between different software.

Aims:

- Planned area will be on 0,2mm depth cylindrical cutter with an 8mm diameter.
- To set a base we will use a roller made of carbide with 6mm diameter, filed on half of diameter.
- The logo will be milled by engraving cutter 20 degree/0.6mm – on 0,3mm depth.

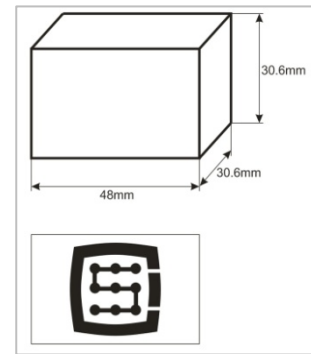

12.1 Project and G-Code files preparing

We create a new project in ArtCam software. Enter dimension of the cube. In this example, the resolution is not very important so you can set it low.

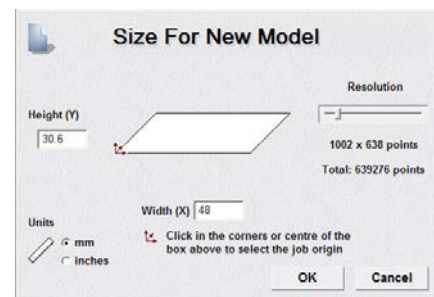

Select Import Vector Data command in Art Cam and in the window that pops up – option that will set our logo in the middle of defined area.

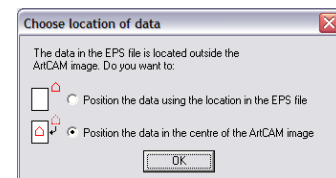

Next, we draw an object, which we use to plan the area. It would be good if the object were larger than our cube, so that the cylindrical cutter will go during the work with its whole diameter out of the material. First, select an icon from the Vector tab, draw a rectangle with the same size like our cube. In the Width and Height boxes enter 48 and 30.6 size. Next click „Create” and „Close”.

Now you need to set the object position. Press right mouse button on it and select „Transform Vectors”.

Select the lower left corner of the object and enter 0,0 position. Press „Apply” and „Close”.

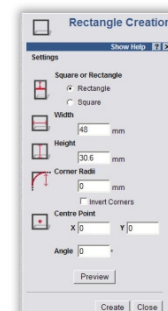
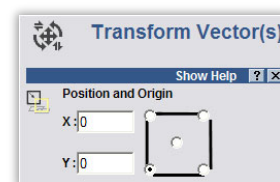



The newly created object with its position and size exactly coincides with the working area. Now you should add the additional enlargement that was mentioned, so that the milling cutter will go with its whole diameter out of the material – thus we get a better surface.

We click on our object and select „Vectors/Offset” menu position. The milling cutter diameter is 8mm - we should give it a small reserve by entering as an Offset Distance the 8.5mm value. We are giving the Offset Direction as Outwards – that is the outside. Offset corners – irrelevant here. Select - Delete original vectors, because we do not need to save the original object.

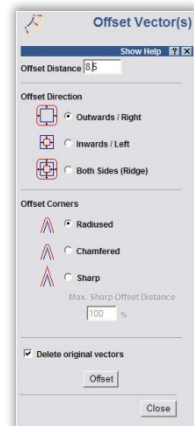

At this stage, our project looks like this:

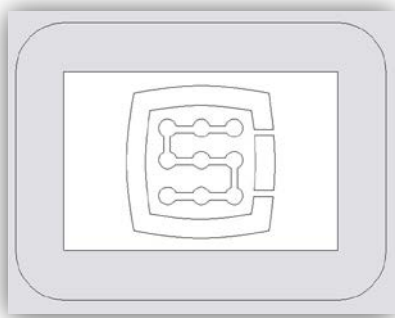

You can now generate trajectories for tools.

First, a tool path for planning the surface.

Select the object we have created and select Area Clearance  icon from Toolpath tab.

In Finish Depth box, enter treatment depth - 0.2mm in this case. In toleration area, enter 0,01mm. As practice shows, it is not worth to overdo with toleration value. Of course, if you have a high-class mechanics, granite construction, all is thermally stabilized, and you execute precise jobs – you can set the toleration more detailed. Safe Z parameter you can set at 5mm, Home Position at [0, 0, 10]. You can also select „Add Ramping Moves” on default parameters, the result is smoother entry into the material.

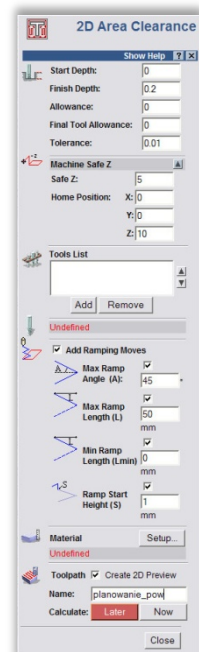



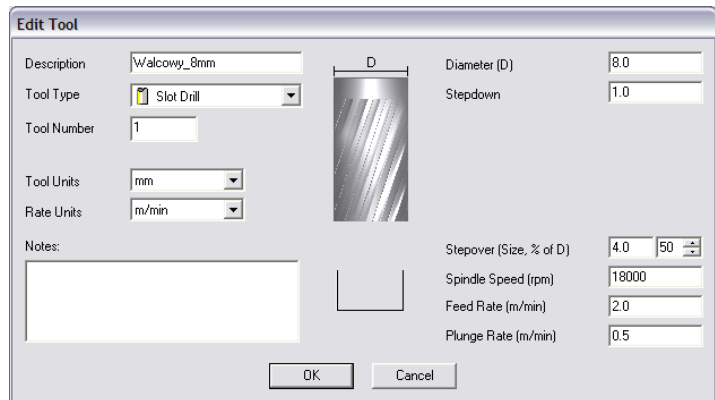

You should inform the software what kind of tool you use. Below the Tool List click the Add button. In the tool-base window, click Add Tool, to add a new tool. Enter parameters as the picture shows. Some parameters like description or diameter are obvious. Step-down is a maximum depth the tool gets. Stepover is a working density. The bigger the density, the generally better surface, but here it is also not worth to overdo because you can only unnecessarily make the treatment last longer. Feed Rate is a feed on XY surface, and Plunge Rate means speed with which the tool will get into the material. Tool Type is a tool shape type. Here the drawing, displayed after shape type selection, is helpful.

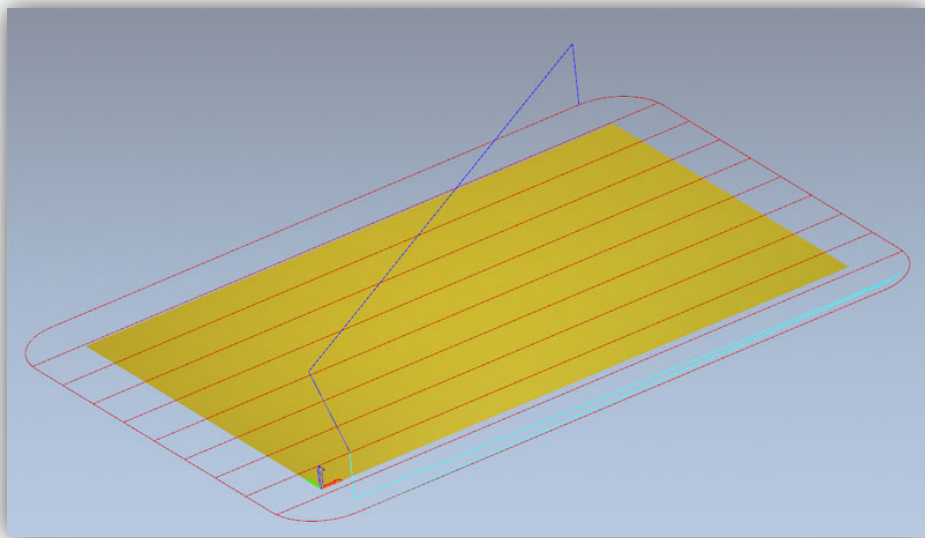

In the end press „OK”, choose our tool from list and click Select.

In Tool List box, in the Area Clearance configuration panel there should our tool appear, now only press Calculate: Now in the bottom of the panel, in the preview of working area there should the calculated tool trajectory appear. We can switch to a 3D view to look closer. It should look something like this:



Now we record the trajectory, go to the Toolpaths tab and click the  icon.

In the record window, select so-called postprocessor, to define output data format suitable for our control system. In ArtCam we recommend „G-Code Arcs (mm) (*.tap)”. It is basic G-Code format suitable for Mach3 software. When you select the format pres „Save” and save our trajectory as e.g. „planning.tap”.

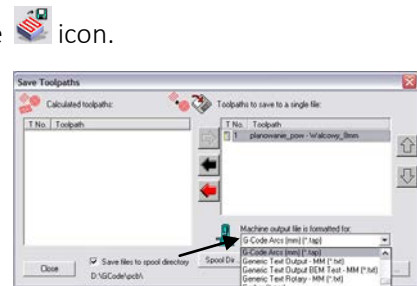





Next, generate tool trajectory for our logo.

Go back to 2D preview, and in the Toolpaths tab panel, next to the last generated path – deselect Show In 2D|3D. Previous trajectory disappears so it will not disrupt our view.

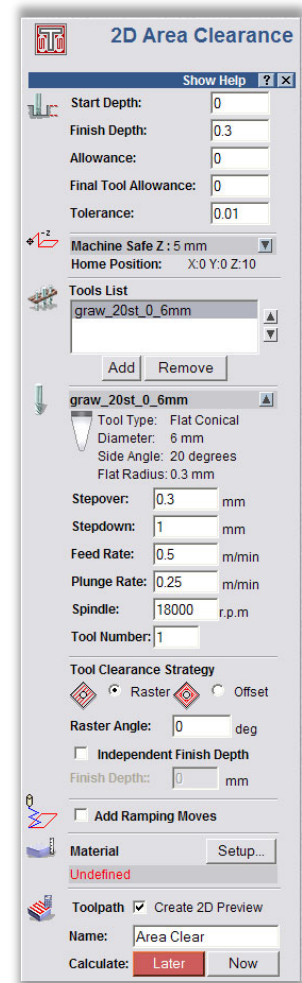
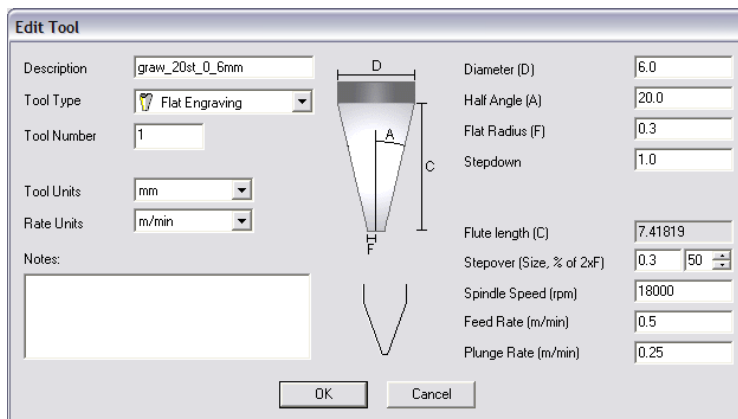
Now select our logo and again click the Area Clearance  icon. We enter the parameters almost the same like before, only the depth is 0.3mm and we deselect „Add Ramping Moves” – it will not be needed in this case, we also need to define other tool. We proceed like before. Press Add - below the tool list - and Add Tool in the tool base window. The parameters in this case look like this:



You should note that, in ArtCam software a handle size is given as diameter, and a dimension of tip of the tool (F) is as radius. Speed values in here are quite low but it is only example, and not “high performance ride”, which makes sense only for mass production for larger number of units. With so simple, single treatments it takes more time to prepare the project, place the material and set the machine than the treatment itself.

When our tool is entered, you can click Calculate: Now and record the path by clicking on the  icon. Postprocessor should stay the same. Name it e.g. „graw_logo.tap”. 3D preview should look like this:

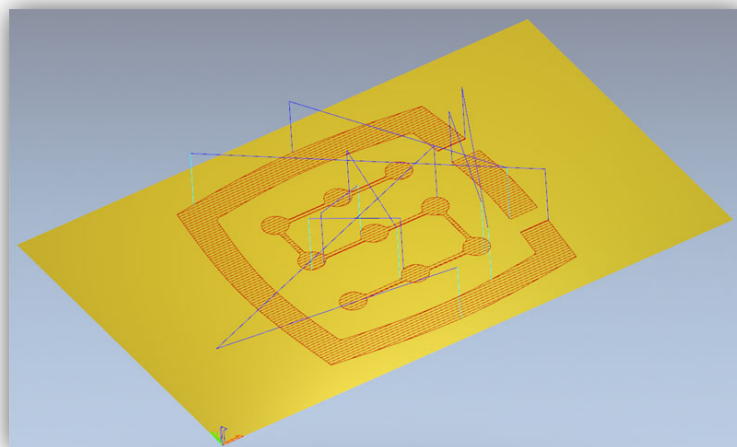



12.2 Preparing machine and Mach3 software

When files are ready, you only need to place and home the material. First, start Mach3 software and reference all the axes pressing „Ref All Home” button on the main screen. Place the material securely, to avoid a risk of its shifting or breaking during the treatment.



As it was mentioned at the beginning – to set the material base we are going to use the carbide roller, filed precisely on half of diameter. If we use tool length measurement, then enter the tool number “1” in a „Tool” box in Mach3 software and start the measurement by pressing „Auto Tool Zero” button.

In the manual feed rate panel set continuous ride mode and 25% speed. At the same time in a Feed rate box, you can enter stepper work feeds, which we will use in a moment -1000 mm/min.

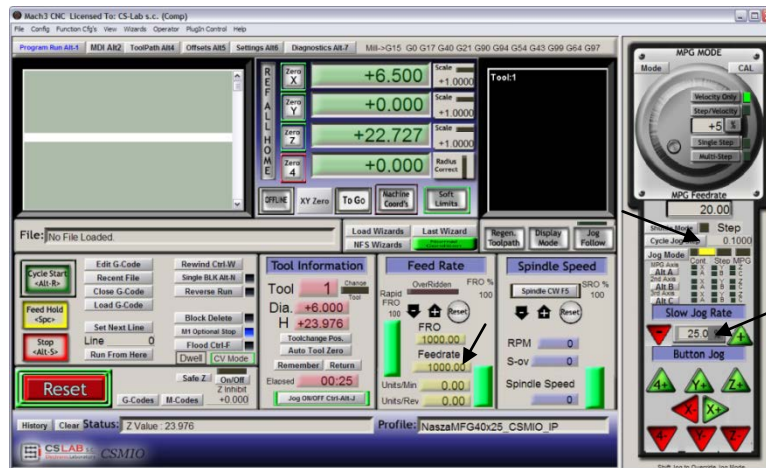

Now use arrow keys or keys on a machine desktop, reach left edge of the material. Z-axis is a little below the material level.



Next, change the feed mode for stepper mode and set the step on 0.1mm. Working with 0.1mm step we get close to the material and then switch to 0.025mm step – enter that value in a text box and press <enter>. Make the half of the filed roller to contact with side surface of the material. If we will try to move the spindle with a finger to any side – we will be able to do that only to a small extent. The roller edges will not let us more. Go by step with another 0.025mm until you will not be able to move the spindle at all – it means that the material surfaces and the filed roller adhere to each other.





At this point, we can set the material base in X-axis by clicking „Zero X” button on the Mach screen. Coordinate X on the screen will be reset.

Switch the feed rate mode on continuous one, „Slow Jog Rate” speed – e.g. 2% because we are very close to the material and the same way we set the Y base on the lower edge of the cube. This way of homing seems to be a little troublesome but with a little practice this can be done very quickly, besides it is quite precise.

When the position is set on the lower edge of the material then click „Zero Y”, to reset the Y coordinate at this point.

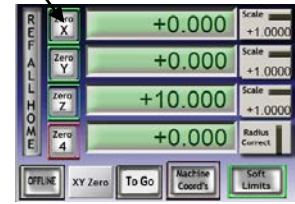

If we do not use the automatic tool length measurement, setting a Z base at this point makes no sense. You should set it only if we place

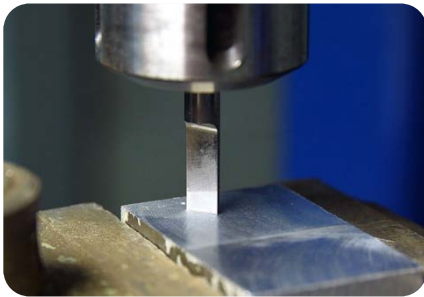

the right tool. However, I assume that such a sensor is installed in the machine.

For Z-axis, we set the base much like XY, raising the axis a little higher above the material level, next lowering it in stepper mode until the lower roller surface touches the material.

Now click the „Zero Z” to reset the Z coordinate at this point.

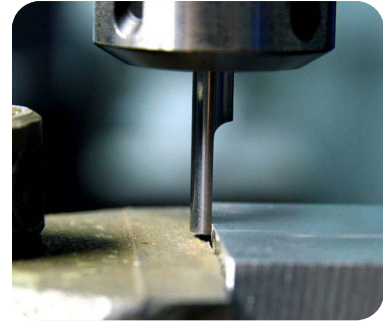

The material base is already set so you can place the correct milling cutter – to plan the surface measure it and load the trajectory file.

After we placed the tool, we measure it clicking „Auto Tool Zero” button.



Automatic tool length measurement is not a standard Mach3 function. Description of this function activation and configuration you can find in chapter 14.1 – „Automatic tool length measurement”.



12.3 We begin the treatment

In Mach software, we select „File/Load G-Code” menu position or we click „Load G-Code” button on the main screen. Select the file we created earlier: „planing.tap”. When the file is loaded, we can initially set the machine over the material and enter on the MDI screen.

- G0G53 Z0 <enter>
- G0 X0 Y0 <enter>

The first command causes the Z-axis rises maximum high, the second one is to set the machines tool XY axes in the defined earlier zero point of the material.

Go to the main screen again and click „Cycle Start” button – the treatment start.

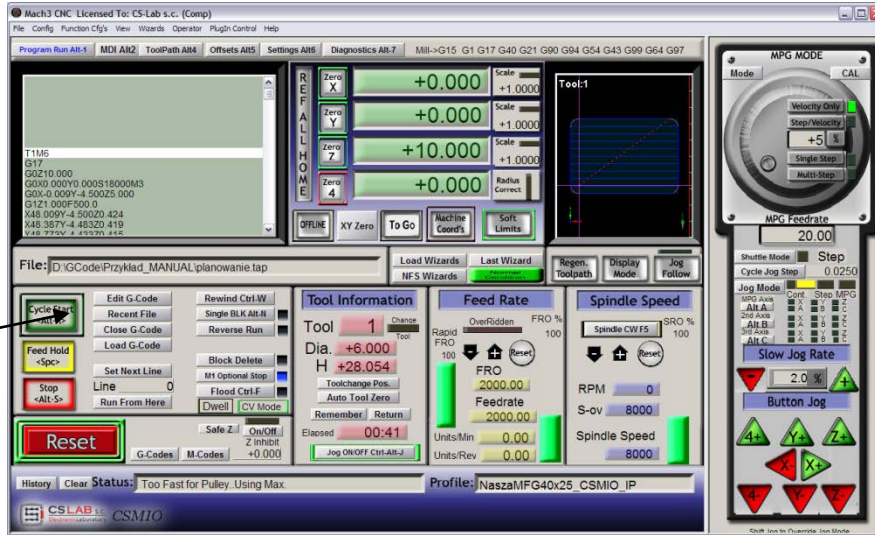

Below a photo taken during the work:



You can change the tool for an engraving cutter and load the second, previously generated trajectory. Before processing, there is one important detail. When planning the surface we lowered its level, the engraving logo would be 0.1mm depth, and not 0.3mm like the one we had assumed. “This can be easily remedied by reducing the zero point level about 0.2mm (planned depth). Click on the text box that displays current Z position and type on your keyboard "0.2 <enter>".





After this operation, we can start work from the second file not forgetting about the measurement after tool change („Auto Tool Zero” button).

When the file is loaded, and the tool is measured we can set the axes again over the material with the MDI like before.

Press „Cycle Start” and start the treatment.

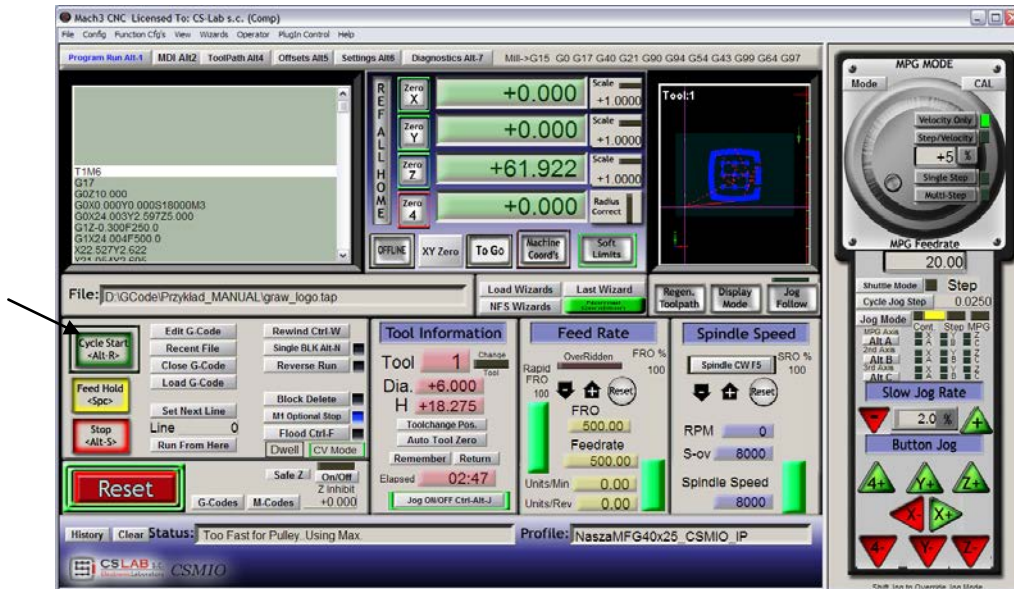



13.A few practical notes about Mach3 software and CSMIO/IP-S

Here you can find few tips that can help users unfamiliar with Mach3 software.

1. Computer keyboard.
 - a. Do not use a wireless keyboard, sometimes this keyboard record keystroke, but does not notice releasing it, which can be very dangerous while controlling the machine.
 - b. In addition – an USB keyboard can behave in unpredictable ways. The USB port is not resistant to interference therefore, especially on machines with servo drives and higher power spindles. We definitely not recommend the USB keyboard.
 - c. The most reliable solution is PS2 keyboard or connection of industrial buttons to CSMIO/IP-S digital inputs and defining them correctly in Mach3 software.
2. Remember that writing down the value in any text boxes on the Mach screen - must always be confirmed by pressing ENTER.
3. If you are doing CNC program at high speeds and sometimes the movement loses its smoothness, check the „LookAhead” parameter in "Config / General config". It is responsible for sections of the trajectory analyzed in advance. Set this parameter to 999.
4. If you are doing CNC program at high speeds and you notice some distortions related to rounded corners then switch on and experiment with "CV Dist. Tolerance" parameter in „Config→General Config”. At the beginning, you can set the value on 0,5 - it will correspond to 0,5mm corner tolerance.
5. Mach3 software as a decimal separator (to separate the fractional part) uses a dot „ . ”. Keep it in mind entering the values.
6. 3D trajectory preview on Mach screen can significantly burden the computer when the files are large. While the machine runs, do not do operations such as zooming, rotation, etc. For very large files, we recommend to turn of the 3D preview - Diagnostics screen, click "Toolpath on / off."
7. If a machine has touched a hardware LIMIT switch, you can back of the switch by "OveRride Limits" button activation on Settings screen. It is also convenience to activate "Auto LimitOverRide" - this will cause that when we touch the limit switch a machine will stop, but you can click RESET and back of the limit switches without any additional operations. Additionally the "Smart Limits" function activated will protect you against motion in wrong direction, which can be cause by e.g. accidentally wrong button pressed.
8. Manual control (JOG).
 - a. Do not forget that pressing TAB key causes that additional side panel appears where you can set speed, continuous or step mode – it makes that controlling the axes and precise setting of material base is easier.
 - b. By pressing the combination of feed rate key (e.g. right arrow) and SHIFT key, the movement is in continuous mode with 100% speed - regardless of the current settings.
 - c. By pressing the combination of the feed rate key and CTRL key – the movement is always in step mode with speed set in FEEDRATE area.
9. Mach3 always starts with tool „0” chosen, if you use a tools changer and some tool left in a handle when you turn off, then after Mach restart, you must enter this tool number (Tool Information group on the main screen, the "Tool").



- a. If you do not use a tool changer but you have an automatic tool-length measurement sensor, then after starting Mach software always enter „1” <enter> into the “Tool”. Similarly, when generating the g-code file in CAM software also always set the tool 1.
10. STOP button on Mach3 screen stops a machine instantly. With stepper motors, it may cause that motor will fall out from the position, with servo drives, the motor controllers may report an overload error or overstaying error and you will need to re-home the machine. Recommended way to stop the work is pressing pause first („Feed Hold”), and after it stopped – the STOP key.
11. To restart CNC program from specified location - set in G-code window desired position (line), then press "Run From Here" and then "Cycle Start".
12. It is worth to know the basic commands of G-Code. In many situations the MDI Mach screen, where you can manually type the commands that are executed immediately is a very useful tool.
13. If you have a tool magazine and/or automatic tool-length measurement sensor, remember that any manipulation/repositioning or disassembly of HOME switches can cause machines absolute zero position shift and then recalibration of magazine and tool length measurement sensor position is necessary.
14. If you set the zero point (material base) and you use an automatic tool measurement – always make the tool measurement first, and then set the zero point. Setting the zero point with unmeasured tool causes that the level of processing shifts when we place another tool and call the measurement.
15. A PC computer you use to control the machine should be treated like an integral part of the control system and should not be used to any other tasks. It means that, this computer should only have operation system, Mach3 software and nothing else (eventually text editor and file manager such as Total Commander®). For any other tasks such as designing, you should use some other computer.
16. On the computer you use to control you should disable all visual effects of your desktop, screen saver, and turn power profile on “always on”.



14. VisualBasic® macros

On our website: www.cs-lab.eu you can download standard scripts for automatic tool-length measurement and for automatic tool change. These are usually the most desirable functions and make work easier. We encourage advanced users to learn more about macros, which provide great opportunities for self-expanding functionality of Mach3 software.

14.1 Automatic tool-length measurement

Automatic tool-length measurement is one of the most implemented function, e.g. because mechanically it is very easy to do. If high measurement accuracy is required, the sensor must be good quality. In CSMIO/IP-S controller – specially for G31 command (used during the measurement) – we implemented completely autonomous movement operation and ultra-fast logic to assure measurement precision at the highest level.



The measurement is made through the following stages:

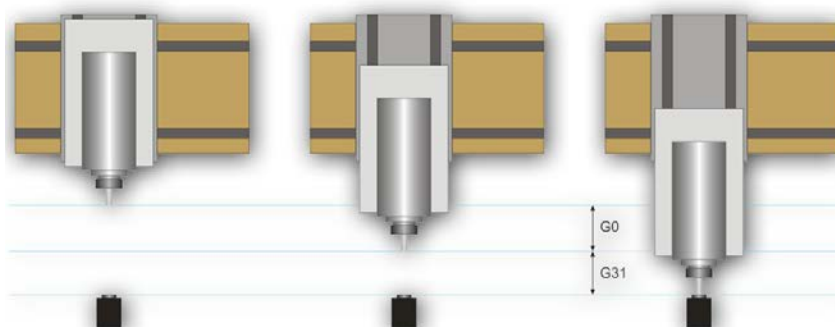

- Raising Z axis at the maximum high (absolute zero)
- Going in a fast mode (G0) at XY sensor position.
- Quick exit (G0) by Z-axis to so-called - safe Z
- Going down in the measurement mode (G31) at "1" speed until signal receiving from the sensor.
- Raising Z-axis with small value (preparing to measurement that is more accurate).
- Going down in the measurement mode (G31) at "2" speed, until signal receiving from the sensor.
- After measurement is finished– raising Z-axis maximally.





14.1.1 Configuration

Before we start the script configuration, you should follow these steps:

1. Check the sensor and inputs signals settings – go to Diagnostics tab and while pushing the sensor with hand observe the  Digitize light indicators on the screen. The light should light up at the moment of pushing the sensor and light should go out after releasing it. In case of any problems go to 10.4 chapter (input signals). The sensor signal in the configuration window is called "Probe".
2. Make reference move of all axes.
3. On the main screen switch the coordinates display mode for machine display (absolute) – icon .
4. Secure the tool in the spindle holder (for the firsts test – the cheapest is the best).
5. In manual feed mode move to the center of the sensor measuring surface. Note XY coordinates.
6. In stepper mode slowly lower the Z axis until the signal from the sensor appears and note the Z coordinate.
7. Go with Z-axis up to the level you consider as safe. A small explanation here - as written above, while measurement there is rapid slide down to some level by G0 command first. You have to assess to what Z-axis level it can slide down quickly. It depends on maximum length of tools that will be measured. You can also enter "0" as a safe Z and then measurement starts from the top position.
8. Move the XY axes to place yourself somewhere above the worktable.
9. Using the stepper mode, slowly slide the tool down to the worktable surface and note the Z coordinate.
10. Turn off the absolute coordinates mode by clicking  icon.

When you have noted all necessary data, open the downloaded toollength.m1s file in any text editor (e.g. notepad). Then select all using mouse or by pressing "CTRL + A" and copy to clipboard - "CTRL + C".

In Mach standard graphical interface, on the main screen there is an "Auto Tool Zero" button. This button is defined by default as calling a macro, so there is no need to add a new button in the graphical editor.

To connect the mentioned above button to our macro, select in the menu: "The operator / Edit Button Script". The "Auto Tool Zero" button and several others should start to blink. Click on it and open Mach3 text editor.

Sometimes there is a single text line, if so - you must delete it, and then press CTRL + V to paste our macro.

Now just enter a few parameters based on the coordinates, which we noted earlier. All configuration data can be found under "Configuration parameters" line.

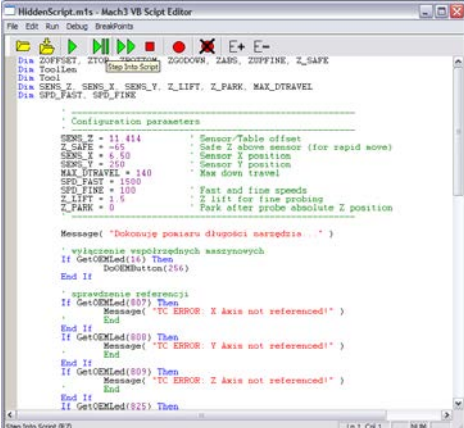

```

HiddenScript.m1s - Mach3 VB Script Editor
File Edit Run Debug Breakpoint
Dim ZOFFSET, ZTO, ZG0DOWN, ZABS, ZOFFLINE, Z_SAFE
Dim ToolLen
Dim Tool
Dim SENS_Z, SENS_Y, SENS_V, Z_LIFT, Z_PARK, MAX_DTRAVEL
Dim SPD_FAST, SPD_FINE

Configuration parameters
SENS_Z = 11414          * Sensor/Table offset
Z_SAFE = -65           * Safe Z above sensor (for rapid move)
SENS_Y = 450           * Sensor Y position
SENS_V = 250           * Sensor Y position
MAX_DTRAVEL = 140      * Max down travel
SPD_FAST = 1000        * Fast end feed speeds
SPD_FINE = 100         * Z lift for fine probing
Z_LIFT = 1             * Park after probe absolute Z position
Z_PARK = 0

Message( "Robocnicz pokazuj dlugosci narzedzia. " )
* wyliczenie wspolrzadnych asszynowych.
If GetOEMled(16) Then
  DoOEMButton(256)
End If

* sprawdzanie referencji
If GetOEMled(807) Then
  Message( "TC ERROR: X axis not referenced!" )
End If
If GetOEMled(808) Then
  Message( "TC ERROR: Y axis not referenced!" )
End If
If GetOEMled(809) Then
  Message( "TC ERROR: Z axis not referenced!" )
End If
If GetOEMled(825) Then
  Message( "TC ERROR: Z axis not referenced!" )
End If

```



Parameter	Details
SENS_Z	[Z coordinate of sensor activation] – [Z coordinate of table level]. If you e.g. when reaching the table Z=-122.070mm, and sensor gave an active signal at Z=-110.656mm – the entered value should be 11.414.
Z_SAFE	It is parameter that describes at what height the Z-axis can slide down fast (G0). If we have doubts how long tools will be measured it is safer to enter „0“.
SENS_X/SENS_Y	X and Y position of the sensor in a machine tool working area.
MAX_DTRAVEL	Maximum distance the axis travels down in the measurement mode. If in measurement mode the Z-axis run this distance, and the sensor signal does not appear – the measurement failed. With this parameter, you can protect yourself from a situation when the measurement was called while the tool was not clamped.
SPD_FAST	First measurement speed (mm/min).
SPD_FINE	Second precise measurement speed (mm/min).
Z_LIFT	Determines how much the Z-axis should be raised before the second measurement. The value should be large enough to change the sensor inactive again while rising.
Z_PARK	Z-level, on which the axis was set before the measurement and after the measurement is finished. Usually – “0”.

Macro should be saved in „File→Save” menu, close the window. After the operation you should also close and restart Mach3 software to make sure that the settings were saved.

That is all. Just click the „Auto Tool Zero” button, and the tool will be automatically measured. Why the table level was checked? It is because adding data the way we showed above – after correct measurement - zero of Z-axis is set on the worktable level. Now if we want to define the zero point of the work piece, and its thickness is e.g. 10.150mm we can enter this value directly into the „Offsets”. In short, the treatment offset in Z-axis is counted from worktable level. Moreover, if we switch „Auto Z Inh” and „Z Inhibit” functions in plugin’s configuration then on Mach3 screen – the controller will activate protection so the tool will not go below working table area. For both JOG movements and g-code making. This way we protect ourselves against worktable damage.

14.2 Automatic tool change macro

On our website <http://www.cs-lab.eu> you can find sample macro that supports automatic tool change (m6Start.m1s). Unfortunately, because of the fact it is more complicated and that very often spindles from different manufacturers have different information signals logistic – it is often required to adjust such a macro strictly to a concrete machine tool.

CS-Lab S.C. Company provides also services for launching, configuration and adaptation of control system to specific requirements.

We also offer complete solutions - the entire control box, launching, configuration and preparation of the macro for specialized tasks, etc.

If you are interested in our offer - please contact with our office: office@cs-lab.eu , +48 52 374 74 34.



Addition A – Slave axis configuration example

With bigger machines you often need to use so called – slave axis. It is about that the physical axis of the machine is powered by two motors.

We implemented in CSMIO/IP-S device the slave axes function with additional option to adjust geometry of a machine. Geometry regulation is very useful if you want to set perpendicular axes precisely.

To understand the rule of slave axis configuration we will use a very common example

- XYZ 3 axis plotter
- Transmission of a drive - toothed bars
- X-axis (gantry) controlled by two motors both sides with pulleys.
- Used phrases: master axis (main) and slave axis (slave).

Defining axes used in Mach3 software

In „Config→Ports and Pins” menu, enable the X, Y and Z-axes. Slave axes are A, B or C. We do not enable the slave axes here. CSMIO/IP-S controller supports slave axis autonomously and activating it as a normal axis may cause conflicts.

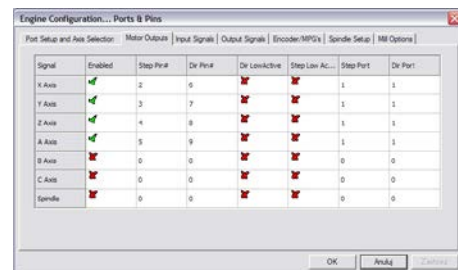

Axis scaling and configuration

We assume that the machine is properly configured as it was described in chapter 10. In „Config→Motor tuning” menu we only configure the Y-axis (master), slave axis is configured automatically. It is important that master and slave axes have the same steps number per millimeter, so you cannot use motors with different encoders or different pulleys.

Activation and choice of *slave* axis

Slave axis function is set in plugin configuration window – „Config→Config Plugins” menu by clicking on „config” next to CSMIO-IP position.

In the example the axis that has two drives is X axis and its assigned slave axis is B axis (A-axis is free, if we would need a rotary axis in the future).

In „ Slave Axis Configuration” group we choose B as „Slave”, set the mode for now to „No correction” and „Geometry Correction” to 0.

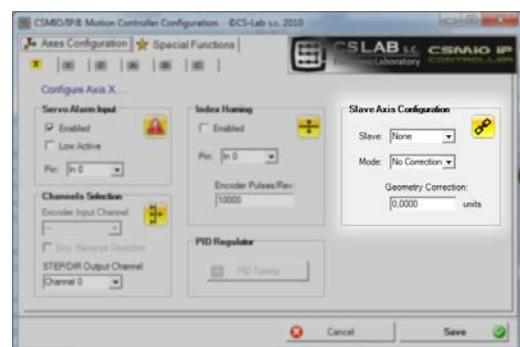



LIMIT and HOMING switches

On both – slave and master axes side – there should be separate LIMIT and HOME switches. The signals should be properly set in Mach3 software („Config→Ports and Pins”).



Before next steps it is necessary to verify if the signals are correctly configured (DIAGNOSTICS tab) Pay special attention whether HOMING switches are not replaced. Pressing by hand the HOME switch on „X” motor side the M1HOME should light up, presing HOME switch on „B” motor side - the M5HOME should light up.

Axis direction settings

One of the most important issues is correct setting of movement directions for master and slave axes. In our example, drive is transmitted by toothed bars. In this case, usually there is need to change slave axis direction. We can do it in „Config→Homing/Limits” by setting „Reversed” at „B” axis. The direction can be also changed in servo drive.

Manual feed test

When all the steps described above are already done, you can attempt to test the axis working in the manual feed. A small note: At the beginning, the best is to set very low speed - even 0.5%. You should first verify whether the motors are working on both sides and whether the feed goes in good directions.

Automatic reading of HOME switches position difference

Before we activate the mode slave axis with geometry correction, you should know what is the position difference of HOME switches on master (“X”) and slave (“B”) side. Homing with geometry correction is about that master axis always finishes homing at the moment it goes back off its HOME switch, and slave axis goes to: [HOME switch back off position - correction]. If we gave zero correction initially and HOME switches position on both sides differs by e.g. 10 mm - then there would be issues with gantry during homing.

To avoid this situation there is additional mode created - for HOME switches position difference measurement.

In plugin configuration window for “X” axis in “Slave Axis Configuration” group enable the „Read Difference” mode and start homing. After homing is finished, open the plugin configuration window again and in „Geometry correction” area there should be the value from the measurement.

Geometry correction mode activation

After correct measurement of HOME switches position difference, in the configuration window you can activate „Sl. correction” mode for „X” axis. Since now on, we can adjust the perpendicularity by modifying "Geometry correction" value. For perpendicularity measurement, we recommend Renishaw® Ballbar system.



You should not use stepper motors for slave axis. Lack of position feedback causes a risk of mechanics of machine damage. With servo-drives, you should always have alarm signals configured correctly.



CS-Lab Company made every effort to ensure reliability of CSMIO/IP-S controller. However, our company does not take any responsibility for any mechanics damage because of wrong configuration and any eventual failure or software errors of CSMIO/IP-S controller.



Addition B – CSMIO/IP-S firmware update

We invite you to visit our website: <http://www.cs-lab.eu> for CSMIO/IP-S firmware updates in a „download” section. The controller updates includes corrections and often enrich the device with new features so it is worth to update the controller regularly.

How to check current firmware version

You can check the controller current firmware version in the diagnostics window from „PlugIn Control→CSMIO_IP_plugin” menu.

The current version is shown on the bottom bar.

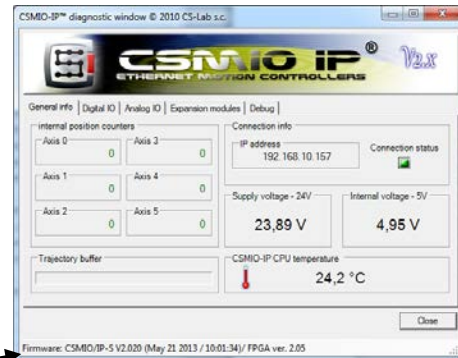

Update application (uploader)

After installer file download – „setup_CSMIO-IP-S-x.xxx.zip” double click and start setup_CSMIO-IP-S-x.xxx file (x.xxx is a firmware version). Installation process was described in chapter „9.3 – Installation of CSMIO/IP firmware”.

At the end of installation leave „Launch CSMIO/IP-S Controller Firmware” option selected and click „Finish”. The application will be launched automatically, thanks to it we update CSMIO/IP firmware. Below you can see the application window and sequence of actions that should be done.

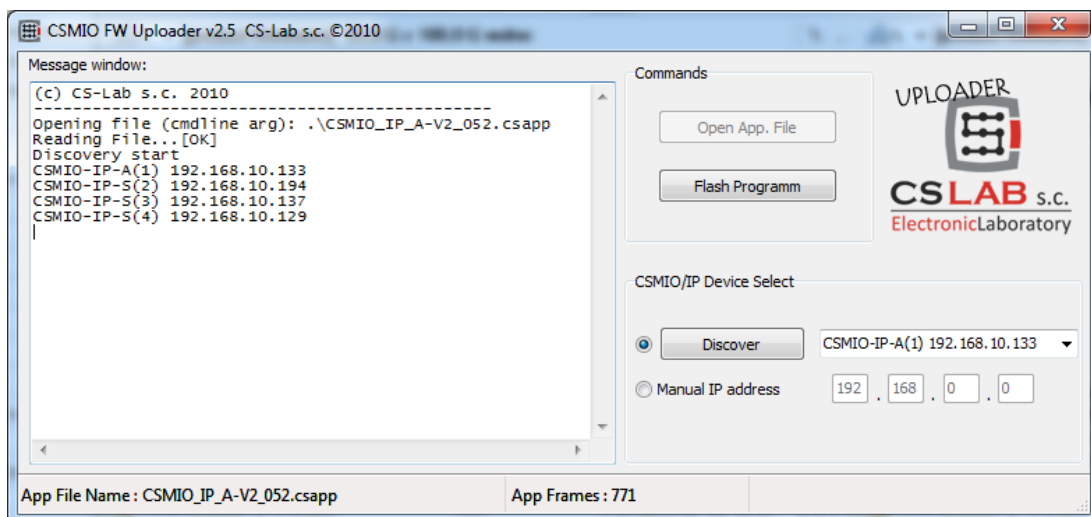

If you run the update application from installer file it means that correct file with the firmware was already loaded and „Open App. File” button is not active. If there is only one CSMIO/IP controller in network - the application asks to start the update automatically. If there are more controllers then you should chose one IP address from a list to update the controller you want and click „Flash Programm”.



CSMIO/IP-S controller is protected if update fails. There is always a possibility to try again



Before update – close Mach3 software.



If you install new firmware version but you do not update with uploader application then Mach3 software during start will inform you about incompatibility between versions and communication will be interrupted.

Plugin file update

Plugin is updated automatically during CSMIO/IP firmware installation.

Update verification

After firmware update is finished, you can start Mach3 again and open diagnostics window. In the bottom bar, you should see your update firmware version.