

Handbook for Disc Springs



Please refer any questions to:

Schnorr Corporation
4355 Varsity Drive Suite A
Ann Arbor, MI 48108
Phone 734-677-2683
Fax 734-975-0408
eMail: sales@schnorr.com
Internet: <http://www.schnorr.com>

© Adolf Schnorr GmbH + Co. KG 2003

All rights reserved.

Reprinting, in full or part, is only possible with express permission and acknowledgement of the source.

Compiled by Dipl.-Ing. (FH) Eberhard Fromm and Ing. (grad.) Wolfgang Kleiner.

We reserve the right to make technical changes without notice. All information is published to the best of our knowledge and has been checked with great care. However, we can accept no responsibility for errors or omissions. We reserve the right to supply features other than those specified.

Art.-No. 900 507 / 04.03

Production: Hela Werbung, Heilbronn

Theoretical basis

This part contains the theoretical basis for the calculation and design of disc springs. You only need to consult chapter 1–2 if you yourself are specifying a special spring size or wish to analyse an existing spring with regard to load and stress.

Practical use of disc springs

This part answers questions resulting from the practical use of disc springs. It is best to select a disc spring by consulting the tables in chapter 9.

Firm grip for bolts

by SCHNORR®-Serrated Safety Washers (Rib washers) and SCHNORR HDS Load Washers

Introduction	p. 5	
Basic Calculation with Examples	p. 13	1
Design and Operation Limits	p. 29	2
Possible Combinations	p. 35	3
Manufacture	p. 41	4
Tolerances	p. 49	5
Application	p. 55	6
Materials	p. 65	7
Special Types	p. 77	8
Dimensional Tables	p. 81	9
Security Elements for Bolted Connections	p. 137	10
Supplement	p. 149	

SCHNORR has now manufactured Disc Springs for over 60 years. This period has been marked by extraordinary technical developments and Disc Springs have found many new and important applications due to their special characteristics and advantages.

In order to meet customer requirements, SCHNORR has constantly raised the quality of its products and researched solutions to customer problems. Looking back, the development of the SCHNORR® Handbook for Disc Springs, which had its origin in the 1930s, is a mirror of SCHNORR's endeavours. The 1942 issue, 60 years ago, already contained characteristic diagrams for 21 standard springs as well as application and installation standards and instructions for empirically based spring calculations. Each new issue revised the technical content to conform to the state of the art.

SCHNORR would like to acknowledge and thank all of its colleagues at the Technical Universities of Braunschweig and Darmstadt for their suggestions and developments in the field of disc springs. Their continued collaboration will ensure that the SCHNORR® Handbook continues to be the source of technical advice on Disc Springs, as it has been for many decades.



A handwritten signature in blue ink that reads "D. Jentsch". The signature is fluid and cursive, with the first letter 'D' being particularly large and stylized.

Dieter Jentsch, Manager
Adolf Schnorr GmbH + Co. KG

In the meantime, the disc spring had been introduced into numerous areas of technology. Starting with applications in the construction of cutting and presswork tools, where the disc spring is especially advantageous because of the large number of variations possible with the same spring size, new applications were quickly found in machine, engine and motor vehicle manufacture.

Technological development is often advanced rapidly in time of war. The disc spring was no exception and its spreading was strongly promoted by the Second World War. For example, its excellent damping characteristics with multiple parallel layers were utilised for the suspension of artillery breeches. Calculation methods and material technology were further developed. After the war the conditions were created for the introduction of the disc spring into all areas of technology.

Adolf Schnorr, who had founded a mechanical workshop in 1908, already began to experiment with the disc spring in the 1920s. He needed high-quality springs for precision tools, with which he had made himself a name, and had come across the disc spring after a long search. As he was unable to procure them anywhere, he went about producing these springs himself. Initially he produced only for his own needs, but the demand had already increased so greatly by the early 1930s that he decided to give up toolmaking for customers and devote himself entirely to the manufacture of the "SCHNORR Spring". From that time on SCHNORR has manufactured disc springs and continually opened up new applications with its many domestic and foreign customers.

Features of the Disc Spring

Compared with other types of springs, the disc spring has a number of advantageous properties, of which the following should be named:

1. Very large loads can be supported with a small installation space.
2. Depending on the dimensional relationships, its spring characteristic can be designed to be linear or regressive and with a suitable arrangement also progressive.
3. Due to the nearly unlimited number of possible combinations of individual disc springs, the characteristic curve and the column length can be further varied within additional limits.
4. High service life under dynamic load if the spring is properly dimensioned.
5. Provided the permissible stress is not exceeded, no impermissible relaxation occurs.
6. With suitable arrangement, a large damping effect may be achieved.
7. Stock keeping is minimised, as the individual spring sizes can be combined universally.
8. Because the springs are of an annular shape, force transmission is absolutely concentric.

On the basis of these excellent properties, the disc spring has been adopted in nearly all areas of technology during the last several decades.

Checklist for disc spring design

Due to the relatively simple geometrical shape the complexity of disc springs in production and application is very often underrated. There are possibilities for mistakes in outlining a disc spring solution, which inevitably cause faulty design or even failures later on. Then it is very difficult to find better substitutes, because most of the times the installation space is fixed.

With a correct design these problems are easy to avoid. The main difficulty is to realize these in the design stage to get an optimum disc spring solution.

Since for most of the designers the disc spring is not daily bread and to many the rules for disc spring design are little known, the most important aspects are summarized here.

Spring force

The calculation of the force of a disc spring is based on a model by Almen and László. Its accuracy in the usable range of the character line of the spring is very good. Yet there is a slow rise at the beginning of the measured load/deflection curve, because disc springs never are perfectly symmetrical. They so to speak have to be pressed even. Also the spring force rises in the last part of the load/deflection curve more than calculated, when the spring is loaded in between two parallel planes, since the leverage changes due to the never ideally even surfaces (see chapter 1.7).

Static loading

In the design of a new disc spring a certain stress level should not be surpassed for static loading. The maximum allowable limit is given by the reference stress σ_{om} . Its value should not exceed the value of the tensile strength R_m of the material to avoid plastic deformations of the spring, i.e. setting losses (chapter 2.1).

Dynamic loading

Most of the disc springs only can bear a limited dynamic load. The life time depends on the load span as well as on the load level (chapter 2.2). The number of cycles, which is to be expected under a certain load condition, can be estimated from fatigue diagrams (chapter 2.2 and chapter „diagrams“). It is also necessary to preload disc springs in a dynamic application to at least 15% to 20% of their maximum deflection, to avoid compression-tension alternating stresses in the beginning of the deflection range of the spring (chapter 2.2).

Stacking

Disc springs can be stacked „face to face“ (series arrangement), which means their deflections add up, or they can be stacked in the same sense (parallel arrangement), then their forces add up (chapter 3). The latter induces increased friction and a stronger hysteresis effect (chapter 6.5). Thus the force in loading direction is higher and in unloading direction lower than the calculated force. Applying suitable lubrication (MoS2 containig grease) can reduce the hysteresis effect. The various possibilities of stacking disc springs can be combined in a stack. Different types of stacking in one spring stack can be used to generate a progressive character line. It is necessary to pay attention to the weaker parts in a combined stacking though, because these normally are pressed flat quite fast, which is not allowed in dynamic loading. If necessary a deflection limitation has to be provided.

Guide

The surface of guide elements in dynamic disc spring applications always has to be harder than the disc springs themselves. A minimum of 55 HRC is advisable, otherwise

the surfaces can be damaged. This again causes uneven movement during the deflection of the spring. The characteristics will be changed and even fatigue cracks can occur (chapter 6.4). Wrong guide clearance also can change the dynamics of loading in a detrimental way (chapter 6.3).

Stack length

Friction and other influences make a spring stack move unevenly. It deflects more on the side of the loading. This effect usually can be neglected for a „normal“ spring stack, but not for long stacks. Therefore the length of a spring stack should not exceed three times the value of the outer diameter. If it is longer, the stack can be stabilized by dividing it with guide washers, which as a rule of thumb should have a thickness of at least one and a half times the guide diameter (chapter 6.1).

Material

The best material for disc springs is standard spring steel. It is always used as long as there are no particular circumstances, which may necessitate a special material. In general special materials have a lower tensile strength and most of the times a different Young's modulus compared to the standard spring steels. Therefore springs out of these materials generally cannot be designed with the same free height, which means that the spring forces are lower (chapter 7).

Temperature

The different materials have different temperature ranges (see table chapter 7.4). Too high temperatures may have a tempering offset, which again results in a loss of force and, in extreme cases, in plastic deformation (setting losses).

Corrosion

Disc springs can be protected against corrosion either by suitable coatings or by using corrosion resistant materials. Such materials are only available in a limited variety of

thicknesses (table chapter 7.4). Also almost all high alloy steels may show stress corrosion cracking at high working stresses.

Hydrogen embrittlement

During the application of certain chemical or electrochemical processes (such as galvanic coating) hydrogen can get into the material and can cause delayed brittle fractures. This cannot be avoided entirely by thermal treatment. Thus processes, which do not bear this risk, are to be preferred.

Standards for Disc Springs

For disc springs the following 2 standards are applicable:

- **DIN 2092 Disc Springs, calculation and**
- **DIN 2093 Disc Springs, dimensions and quality specifications.**

New editions of both of these appeared in January 1992. These standards are governing our production and are also basic for the present SCHNORR® Handbook for Disc Springs.

DIN 2092 covers the standard calculations based on a paper by J.O. Almen and

A. László ^[2] which has been proven in practice for many years. It has been modified in the last few years to include disc springs with contact flats.

DIN 2093 contains 3 dimensional series for disc springs differentiated by outer diameter, thickness and h_0/t ratio. It also contains comprehensive quality requirements for type, dimensions, material, permissible stress, permissible set, guide clearance and the testing of disc springs. Details of these requirements can be found in chapter 2 and 4 – 7.



Disk Springs from the SCHNORR Product Range

The SCHNORR® Production Programme

In addition to springs as per the dimensions contained in DIN 2093, we manufacture many more spring sizes in accordance with our works standard, for which we also apply the quality regulations of DIN 2093. These also include the springs of the "Z" series with dimensions in inches and the "K" series intended for the special purpose of preload-

ing ball bearings. The technical data for all these springs of standard spring steel can be found in the tables in chapter 9.

Besides these, we also supply many disc springs in special sizes from 3.0 mm to 1000.0 mm in diameter and up to a thickness of 80.0 mm of spring steel and all technically possible special materials. Such springs of-

fer the advantage of being optimally adapted to the respective requirements. However, in each individual case the practicality of production must be examined, and the final decision always remains ours.

We recommend you contact our Technical Consulting Service in the design stage, when we will gladly offer our knowledge, experience and resources in the calculation and design of disc springs.

From section “Features of the Disc Spring” it can also be seen that the characteristics of the disc spring are also excellently suited for locking screw. We have developed our Original SCHNORR® Serrated Safety Washers for this purpose. These are detailed in chapter 10 together with Load Washers as per DIN 6796.

Diagram of a Disc Spring

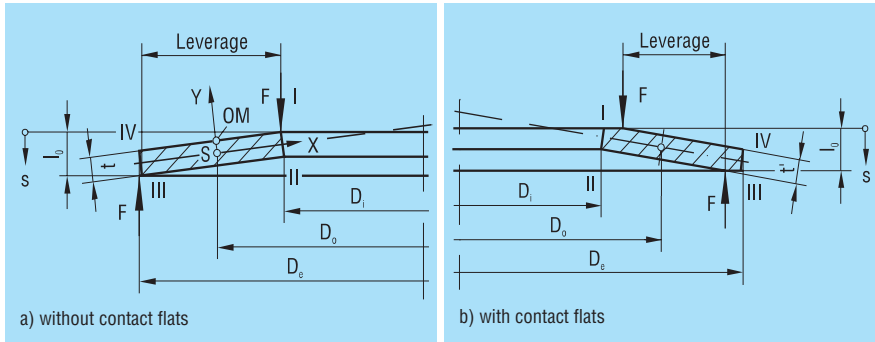

Figure 1
Single spring, cross-section and position of reference points

Symbols and Units

Symbols	Unit	Designation
D_e	mm	Outside diameter
D_i	mm	Inside diameter
D_w	mm	Diameter at the root of slots in a disc spring
D_o	mm	Diameter of centre of rotation
E	N/mm ²	Young's modulus
F	N	Spring force of a single spring
F_1, F_2, F_3	N	Spring force for deflections s_1, s_2, s_3
F_c	N	Calculated spring force of a single spring when flat
F_{ges}	N	Spring force of a spring set or stack
ΔF	N	Force lost in setting
K_1, K_2, K_3, K_4		Constants for calculations (see chapter 1)
L_0	mm	Unloaded length of the spring stack or spring sets
L_1, L_2, L_3	mm	Length of the loaded spring stack or spring set for forces F_1, F_2, F_3
L_c	mm	Calculated length of the spring stack or set when springs are flat
N		Number of cycles to failure
R	N/mm	Spring rate
W	Nmm	Spring work

Symbols	Unit	Designation
h_0	mm	Cone height of an unloaded single spring (calculated $h_0 = l_0 - t$)
h_0'	mm	Cone height of an unloaded spring with reduced thickness t' (and contact flats, calculated $h_0' = l_0 - t'$)
i		No. of single springs or sets in series in a stack
l_0	mm	Height of an unloaded single spring
n		No. of parallel springs in a set
s	mm	Deflection of a single spring
s_1, s_2, s_3	mm	Deflections relative to loads F_1, F_2, F_3
s_{ges}	mm	Deflection of a spring set or stack
t	mm	Thickness of individual
t'	mm	Reduced spring thickness for springs with contact flats (group 3)
w_M, w_R		Friction factors
$\delta = D_g/D_i$		Diameter ratio
μ		Poisson's ratio (for spring steel = 0.3)
σ	N/mm ²	Calculated stress
$\sigma_{OM}, \sigma_I, \sigma_{II}, \sigma_{III}, \sigma_{IV}$	N/mm ²	Calculated stress at points OM, I, II, III and IV as per figure 1
σ_0	N/mm ²	Calculated maximum stress for springs with dynamic loads
σ_u	N/mm ²	Calculated minimum stress for springs with dynamic loads
σ_h	N/mm ²	Stress range for the working stroke of dynamically loaded springs
σ_0	N/mm ²	Maximum stress for fatigue resistance
σ_u	N/mm ²	Minimum stress for fatigue resistance
$\sigma_H = \sigma_0 - \sigma_u$	N/mm ²	Permissible stress range for fatigue resistance

Basic Calculation

Chapter 1

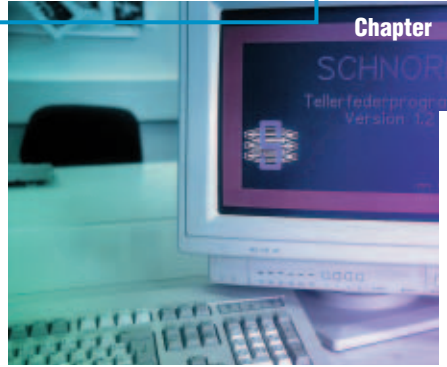

1.1 Calculation for a Single Spring	15
1.2 Equations for Calculations	15
Characteristics	15
Spring Force	16
Stress Calculations	17
Spring Rate	17
Spring Work	18
1.3 Disc Springs without Contact Flats	18
1.4 Disc Springs with Contact Flats and Reduced Thickness	19
1.5 Disc Springs of Special Materials	21
1.6 Spring Parameters for Dimensions and Calculation	21
1.7 Characteristics of a Single Spring	22
1.8 Calculation Examples	24

1.1 Calculation for a Single Spring

The calculations of Almen and László assume that a spring flank rotates around a centre of rotation during deflection, placed in the centre of the spring flank at diameter D_0 .

Formula 1

$$D_0 = \frac{D_e - D_i}{\ln D_e / D_i}$$

The rotation of the cross section is the reason for the various stresses and the spring effect.

The calculations assume that Young's modulus 'E' remains linear for the material, the spring cross-section is rectangular with sharp corners and the spring remains in one plane during deflection. The load is applied at points I and III. There is residual stress in the spring after being manufactured and heat treated and can be ignored.

Although today there are more accurate methods of calculation ^{[10][12][13]}, there is no reason to abandon the simple and convenient formulas of DIN 2092. For standard dimensions they produce values which correspond well to the measured results.

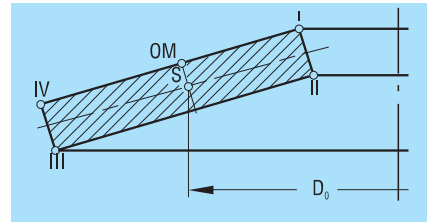

Figure 2
Position of the centre of rotation and point OM

1.2 Equations for Calculations

These are valid for all disc springs:

Characteristics

Formula 2

$$\delta = D_e / D_i$$

Formula 3

$$K_1 = \frac{1}{\pi} \cdot \frac{\left(\frac{\delta - 1}{\delta}\right)^2}{\frac{\delta + 1}{\delta - 1} - \frac{2}{\ln \delta}}$$

Formula 4

$$K_2 = \frac{6}{\pi} \cdot \frac{\frac{\delta - 1}{\ln \delta} - 1}{\ln \delta}$$

Formula 5

$$K_3 = \frac{3}{\pi} \cdot \frac{\delta - 1}{\ln \delta}$$

Formula 6

$$K_4 = \sqrt{-\frac{C_1}{2} + \sqrt{\left(\frac{C_1}{2}\right)^2 + C_2}}$$

$$\text{with } C_1 = \frac{\left(\frac{t'}{t}\right)^2}{\left(\frac{1}{4} \cdot \frac{l_0}{t} - \frac{t'}{t} + \frac{3}{4}\right) \left(\frac{5}{8} \cdot \frac{l_0}{t} - \frac{t'}{t} + \frac{3}{8}\right)}$$

$$\text{and } C_2 = \frac{C_1}{\left(\frac{t'}{t}\right)^3} \left[\frac{5}{32} \left(\frac{l_0}{t} - 1\right)^2 + 1 \right]$$

Spring Force

Formula 7

$$F = \frac{4E}{1-\mu^2} \cdot \frac{t^4}{K_1 \cdot D_e^2} \cdot K_4^2 \cdot \frac{s}{t} \left[K_4^2 \cdot \left(\frac{h_0 - s}{t} \right) \left(\frac{h_0 - s}{t} - \frac{s}{2t} \right) + 1 \right]$$

For disc springs manufactured to group 1 and 2 (chapter 4) $K_4 = 1$:

Formula 8a

$$F = \frac{4E}{1-\mu^2} \cdot \frac{t^4}{K_1 \cdot D_e^2} \cdot \frac{s}{t} \left[\left(\frac{h_0 - s}{t} \right) \left(\frac{h_0 - s}{t} - \frac{s}{2t} \right) + 1 \right]$$

For disc springs manufactured to group 3 with contact flats and reduced thickness, t' and h_0' must be used ($h_0' = l_0 - t'$):

Formula 8b

$$F = \frac{4E}{1-\mu^2} \cdot \frac{t'^4}{K_1 \cdot D_e^2} \cdot K_4^2 \cdot \frac{s}{t'} \left[K_4^2 \left(\frac{h_0'}{t'} - \frac{s}{t'} \right) \left(\frac{h_0'}{t'} - \frac{s}{2t'} \right) + 1 \right]$$

Young's modulus 'E' is virtually independent of the heat treatment condition and tensile strength of the material.

For steel springs with dimensions in accordance with DIN 2093, formula 7 provides values which correspond closely to the measured values. The limitations and extent of this are explained in greater detail in chapter 1.

The force of a disc spring does not increase linearly with the deflection, but is always regressively curved. Its pitch, i.e. the rate, decreases with increasing stroke. The rate of curvature is determined exclusively by the ratio h_0/t , as can be seen in figure 3. See also chapter 1.

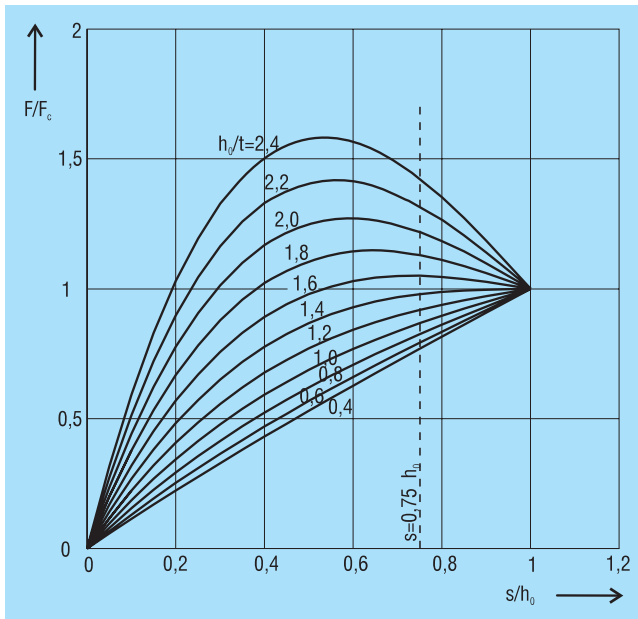

Figure 3
Spring characteristic curve with respect to h_0/t and s/h_0

Stress Calculations

Formula 9

$$\sigma_{0M} = -\frac{4E}{1-\mu^2} \cdot \frac{t^2}{K_1 \cdot D_e^2} \cdot K_4 \cdot \frac{s}{t} \cdot \frac{3}{\pi}$$

Formula 10

$$\sigma_I = -\frac{4E}{1-\mu^2} \cdot \frac{t^2}{K_1 \cdot D_e^2} \cdot K_4 \cdot \frac{s}{t} \left[K_4 \cdot K_2 \left(\frac{h_0}{t} - \frac{s}{2t} \right) + K_3 \right]$$

Formula 11

$$\sigma_{II} = -\frac{4E}{1-\mu^2} \cdot \frac{t^2}{K_1 \cdot D_e^2} \cdot K_4 \cdot \frac{s}{t} \left[K_4 \cdot K_2 \left(\frac{h_0}{t} - \frac{s}{2t} \right) - K_3 \right]$$

Formula 12

$$\sigma_{III} = -\frac{4E}{1-\mu^2} \cdot \frac{t^2}{K_1 \cdot D_e^2} \cdot K_4 \cdot \frac{1}{\delta} \cdot \frac{s}{t} \left[K_4 \cdot (K_2 - 2K_3) \cdot \left(\frac{h_0}{t} - \frac{s}{2t} \right) - K_3 \right]$$

Formula 13

$$\sigma_{IV} = -\frac{4E}{1-\mu^2} \cdot \frac{t^2}{K_1 \cdot D_e^2} \cdot K_4 \cdot \frac{1}{\delta} \cdot \frac{s}{t} \left[K_4 \cdot (K_2 - 2K_3) \cdot \left(\frac{h_0}{t} + \frac{s}{2t} \right) + K_3 \right]$$

Here

$$\frac{4E}{1-\mu^2} = 905\,495 \text{ N/mm}^2$$

also applies to spring steel. Positive values are tensile stress and negative values are compressive stress. It is important to re-

member that this the calculated stress is a nominal value and that the actual stress is considerably lower, as it is considerably influenced by the ever-present internal stress.

Spring Rate

Through differentiation of the spring load F in accordance with the deflection s , the following formula is obtained for spring rate R :

Formula 14

$$R = \frac{dF}{ds} = \frac{4E}{1-\mu^2} \cdot \frac{t^3}{K_1 \cdot D_e^2} \cdot K_4^2 \cdot \left[K_4^2 \left\{ \left(\frac{h_0}{t} \right)^2 - 3 \cdot \frac{h_0}{t} \cdot \frac{s}{t} + \frac{3}{2} \left(\frac{s}{t} \right)^2 \right\} + 1 \right]$$

The spring rate between any two adjacent points, F_1, s_1 and F_2, s_2 can be approximated by means of the following simple formula:

Formula 15

$$R = \frac{F_2 - F_1}{s_2 - s_1}$$

Spring Work

The work done by a disc spring can be obtained by integrating formula 7 for the load F according to the deflection s :

Formula 16

$$W = \int_0^s F \cdot ds = \frac{2E}{1-\mu^2} \cdot \frac{t^5}{K_1 \cdot D_e^2} \cdot K_4^2 \cdot \left(\frac{s}{t}\right)^2 \cdot \left[K_4^2 \cdot \left(\frac{h_0}{t} - \frac{s}{2t}\right)^2 + 1 \right]$$

For a limited area of application it can be integrated between the two deflections s_1 and s_2 .

1.3 Disc Springs without Contact Flats

For disc springs without contact flats $K_4 = 1$ and $h_0 = l_0 - t$. This applies to all disc springs in production groups 1 and 2 (see chapter 2), i.e. with a thickness of up to 6.0 mm.

Because of the rectangular cross-section with rounded corners, as is specified for springs in groups 1 and 2, the application of load in practice always takes place via slightly shortened lever arms (figure 4). Due to the h/H tolerance for the outer and inner diameters, the lever arms are shortened even further. This results in an increase in the spring

load by the factor $\frac{D_e - D_i}{D_e' - D_i'}$

in virtually all springs compared to the values calculated with formula 7.

This conditions takes the standard DIN 2093 into consideration in that the thickness tolerances toward the minus side are clearly larger than toward the plus side. Therefore, we manufacture all springs with a slightly reduced disc thickness. This reduction in the lever arm length is also an explanation for the fact that the permissible deviations for the spring loads for groups 1 and 2 are considerably larger toward the plus than the minus side.

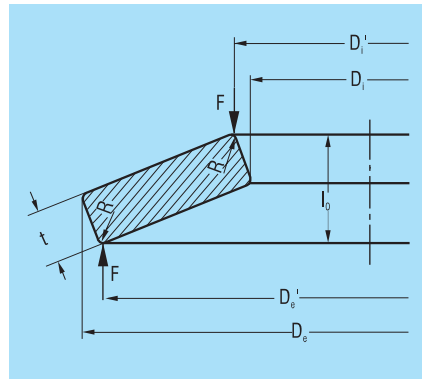

Figure 4
Cross-section of a disc spring in group 2

1.4 Disc Springs with Contact Flats and Reduced Thickness

For disc springs with a thickness of more than 6.0 mm, DIN 2093 specifies small contact surfaces at points I and III in addition to the rounded corners. Figure 5 shows a schematic cross-section of a spring in group 3 as per DIN 2093. The corresponding springs of our factory standard are also manufactured in the same manner.

These contact flats improve definition of the point of load application and, particularly for spring stacks, reduce friction at the guide rod. The result is a considerable reduction in the lever arm length and a corresponding increase in the spring load. This is in turn compensated for by a reduction in the spring thickness from t to t' .

When calculating disc springs with contact flats and reduced thickness, the factor K_4 must be calculated using formula 6, and t replaced with t' and h_0 with $h_0' = l_0 - t'$ in the equations 7 to 16.

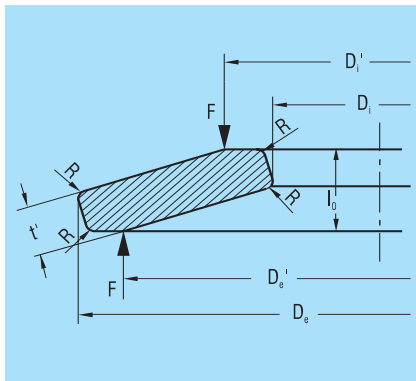

Figure 5
Cross-section of a disc spring in group 3

The reduced thickness t' is specified in accordance with the following conditions:

- The overall height l_0 remains unaltered.
- The width of the contact flats is to be approximately 1/150 of the outside diameter.
- The spring load for a reduced-thickness spring must be the same at $s = 0.75 h_0$ as for an unreduced spring.

The dimension t' is specified for those disc springs contained in DIN 2093. The mean factor t'/t is:

Series	A	B	C
t'/t	0.94	0.94	0.96

For other springs the factor for t'/t is dependent on the dimensional ratio δ and h_0/t from figure 6. The curves were calculated for disc springs with $\sigma_{OM} = -1600 \text{ N/mm}^2$. For springs with different stress s_{OM} , we would ask you to contact our Technical department.

As the overall height is not reduced, springs with reduced thickness inevitably have an increased flank angle and a greater cone height h_0' than springs of the same nominal dimension without reduced thickness. Therefore, the characteristic curve is altered and becomes more curved. Figure 7 shows the characteristic curves for springs of the series A, B and C as per DIN 2093 with and without contact flats and reduced thickness.

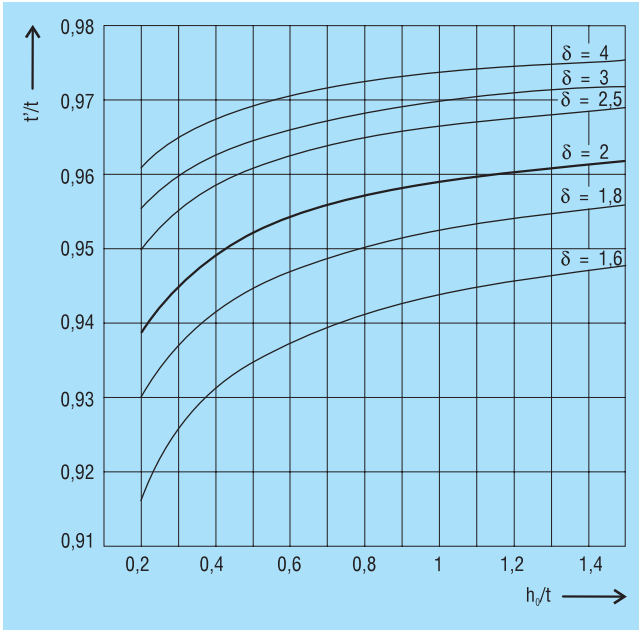

Figure 6
Factor t'/t for disc springs
with
 $s_{DM} = -1600 \text{ N/mm}^2$

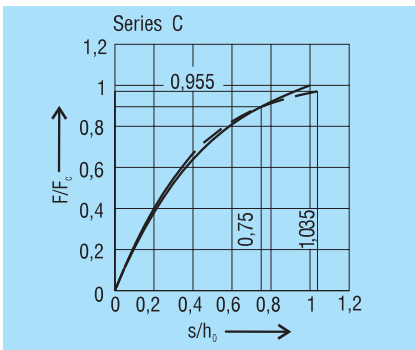
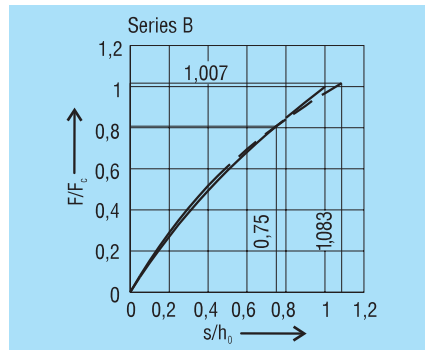
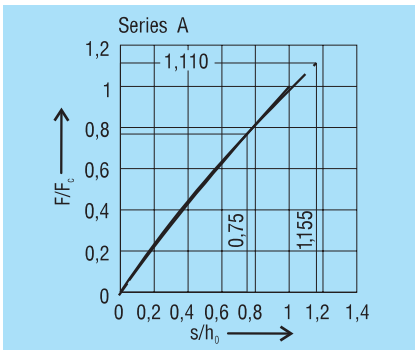

Figure 7
Calculated characteristics for disc springs with and without contact flats. F_c is valid for springs without contact flats (continuous line).

1.5 Disc Springs of Special Materials

When special materials are used with different 'E' moduli and Poisson's ratio μ , it is recommended that the corresponding 'E' modulus is used, but that the value of 0.91 for $1-\mu^2$ be retained. This is justified with the fact that formula 7 for steel with

$E = 206\,000\text{ N/mm}^2$ and $\mu = 0.3$ provides loads $8-9\%$ higher, however this is more or less balanced out again by radii and cross-section-related shortening of the lever arm.

1.6 Spring Parameters for Dimensions and Calculation

Disc springs are determined essentially by the following three parameters:

$$\delta = \frac{\text{Outside diameter } D_e}{\text{Innendurchmesser } D_i}$$

$$h_o/t = \frac{\text{Cone height } l_o - t}{\text{Disc thickness } t}$$

$$D_e/t = \frac{\text{Outside diameter } D_e}{\text{Disc thickness } t}$$

If at all possible, the parameters above should be within the following values:

$$\delta = 1.75 \dots 2.5$$

$$h_o/t = 0.4 \dots 1.3$$

$$D_e/t = 16 \dots 40$$

For smaller values δ , smaller values of h_o/t and D_e/t also apply and vice-versa.

For steel springs with dimensions within these limits, formula 7 can be used without restriction. For very thin disc springs ($D_e/t > 50$) the formula results in spring forces which are too high.

For very narrow disc washers with a ratio of diameters of $D_e/D_i < 1.75$, the shortening of the lever arm must be considered when calculating the force. This is brought about by the rectangular cross-section and by the rounded edges (chapter 1) and results in the calculation of too low a load. In all such cases please consult us.

1.7 Characteristics of a Single Spring

The value h_0/t determines the amount of curvature of the spring characteristic (figure 3). For $h_0/t < 0.4$, the characteristic is almost linear, as the value h_0/t increases, the curve becomes more regressive. At $h_0/t = \sqrt{2}$ the curve has a nearly horizontal segment (at $s = h_0$ it has a horizontal tangent). This means that springs can be developed with an almost horizontal characteristic, which gives very little load increase with deflection. However, this type of spring with $h_0/t > 1.3$ is not suitable for long spring stacks, as individual springs within the stack may move unevenly and be overloaded. As a result, such springs should only be used alone.

From the dependence of the characteristic curvature from the ratio h_0/t , follows that

the characteristic curve of disc springs of the same dimensions changes when they are formed to a different height. Conversely, at the same height h_0 , a thinner disc will have a more regressive characteristic curve than a thicker disc (figure 8).

On the other hand, the force of the flattened disc spring increases linearly. If, for example, a spring calculation cannot predict this in a satisfactory manner, then a first step in the form of a change in the free height may already produce the desired load/deflection diagram. Here, however, the permissible stress must be observed, as these increase with increasing cone height h_0 .

Figure 8
Characteristic of a single disc with different height h_0

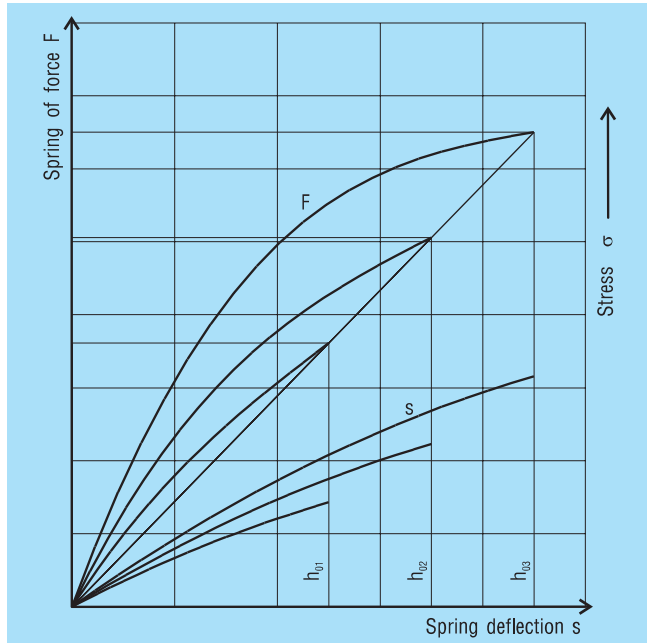

At $h_0/t > \sqrt{2}$, the spring force reaches a maximum and then decreases again. In some cases the decreasing segment of the curve is utilised. Under certain conditions the spring must be loaded beyond the flat position, for which certain design conditions must be given (figure 9).

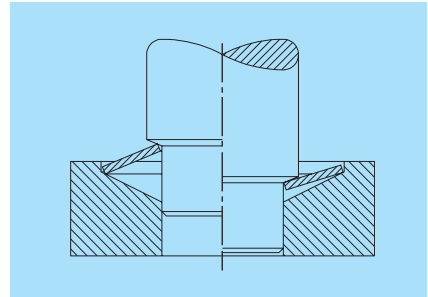

Figure 9
Spring loaded beyond the flat position

For the normal arrangement of disc springs a progressive increase in the spring force occurs at deflections of $s > 0.75 h_0$ which deviates from the calculated value. This results from the shift in the load points to smaller lever arms, because the disc springs

roll on each other or on the abutments. Therefore, it is recommended that only approx. 75 to 80 % of the spring deflection is utilised. For this reason, the spring force is only indicated at $s \approx 0.75 h_0$ in DIN 2093 (figure 10).

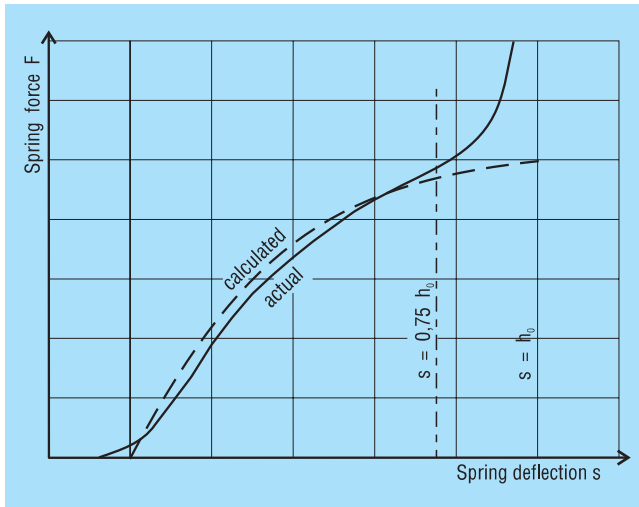

Figure 10
Calculated and actual characteristic

1.8 Calculation Examples

The section "Diagrams" contains the characteristics for all springs in our standard range. The "life lines" also allow the fatigue life to be estimated for various working strokes. In

spite of this we show several examples of the calculation and checking of disc springs below.

Example 1: Checking Fatigue Life of a Disc Spring

Given:

- Spring 45 x 22.4 x 1.75; $l_0 = 3.05$ mm
- Preload $F_1 = 1580$ N
- Final load $F_2 = 2670$ N
- Frequency $f = 1000$ /min

To be determined:

- Is the stress within the acceptable range
- what is the estimated fatigue life.

Solution:

From the tables of section 9.2 we can obtain the following data:

s/h_0	s [mm]	F [N]	s [N/mm ²]
0.25	0.325	1524	433
0.5	0.650	2701	814
0.75	0.980	3659	1148
1.0	1.300	4475	1421

With the help of these four points the load and stress relative to the deflection may be drawn.

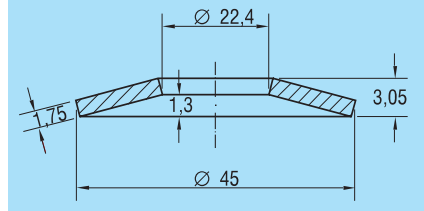

Figure 11
Disc spring 45 x 22.4 x 1.75; $l_0 = 3.05$ mm

The following values may be obtained from the diagram (figure 12):

- $s_1 = 0.34$ mm, $s_2 = 0.64$ mm
- $\sigma_u = 450$ N/mm²
- $\sigma_o = 804$ N/mm²

From the fatigue diagram for group 2 springs figure 19, we obtain $\sigma_u = 450$ N/mm² with a maximum stress of $\sigma_o = 920$ N/mm². Therefore the spring is fatigue resistant as $\sigma_o < \sigma_u$.

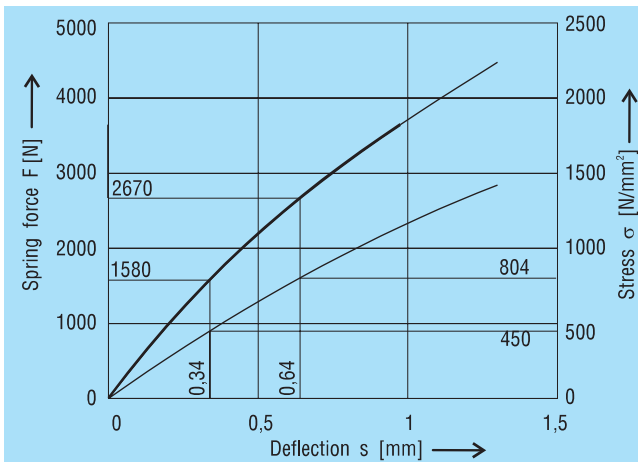

Figure 12
Diagram for spring
45 x 22.4 x 1.75 mm,
 $l_0 = 3.05$ mm

Example 2: Disc Springs with a high h_0/t Ratio

Given:

- Guide diameter 30 mm
- Installed length $l_1 = 4,9$ mm
- Preload $F_1 = 2000$ N min.
- Working defl. $s_2 - s_1 = 1.05$ mm
- Spring load $F_2 = 2500$ N max.

Required:

Suitable Disc Spring Dimensions

Solution:

- Spring inside diameter $D_i = 30.5$ mm
- Spring outside diameter $D_e = 60$ mm (selected because of the favourable D_e/D_i ratio).
- Because of the very small load range and the small installed length only a spring with a high h_0/t ratio is suitable.

Selected:

- Disc spring 60 x 30.5 x 1.5 mm;
- $l_0 = 3.5$ mm $h_0/t = 1.333$; $\delta = 1.967$

Calculation:

First the factors are calculated using formula 3, 4 and 5:

- $K_1 = 0.688$
- $K_2 = 1.212$
- $K_3 = 1.365$

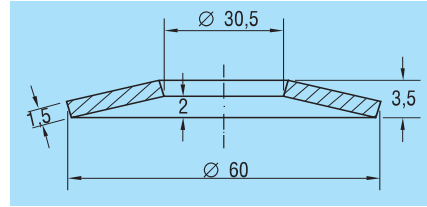

Figure 13
Disc spring 60 x 30.5 x 1.5 mm

The stress σ_{OM} can be checked using formula 9:

$$\sigma_{OM} = -1048 \text{ N/mm}^2$$

This value lies well under the limit of -1600 N/mm², the spring will therefore not set.

Now the spring loads can be calculated to formula 8a, preferably for the 4 deflections $s = 0.25h_0$, $s = 0.5 h_0$, $s = 0.75h_0$ and $s = h_0$.

One obtains the following values:

s/h_0	s [mm]	F [N]
0.25	0.5	1338
0.5	1.0	2058
0.75	1.5	2367
1.0	2.0	2469

With these 4 points the spring diagram can be drawn.

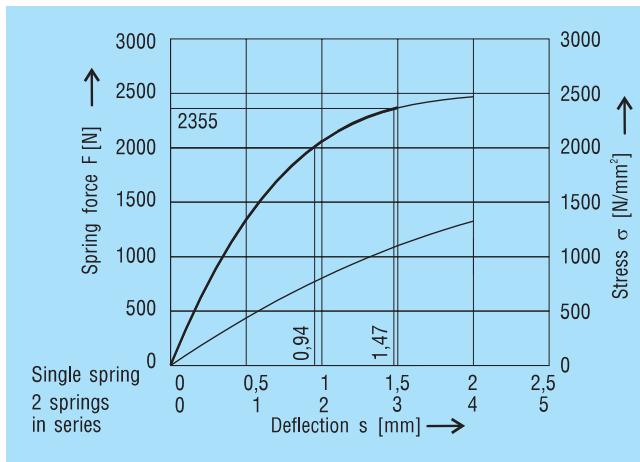

Figure 14
Diagram for spring
60 x 30.5 x 1.5 mm,
 $l_0 = 3.5$ mm

One can read $F_1 = 2100 \text{ N}$ $s_1 = 1.05 \text{ mm}$
 and for $F_2 = 2400 \text{ N}$ $s_2 = 1.61 \text{ mm}$
 Deflection $s_2 - s_1 = 0.56 \text{ mm}$

The deflection of a single spring is not sufficient, therefore two in series must be used.

This arrangement gives:

Unloaded length: $L_0 = 7.0 \text{ mm}$
 Preloaded length: $L_1 = 4.90 \text{ mm}$
 Preloaded deflection: $s_1 = 2.1 \text{ mm}$
 Preload: $F_1 = 2100 \text{ N}$
 Deflection $s_2 = s_1 + 1.05 = 3.15 \text{ mm}$
 Final load $F_2 = 2390 \text{ N}$

To check the fatigue life we must use the stresses at $s_1 = 1.05$ and $s_2 = 1.575 \text{ mm}$. Figure 17 shows that point III is the dominant one, this gives:

$$s_1: \sigma_u = 843 \text{ N/mm}^2$$

$$s_2: \sigma_o = 1147 \text{ N/mm}^2$$

By utilising the fatigue life diagram in figure 19 we can see that the expected life will be in the order of 1,000,000 cycles.

Example 3: Calculation of a Disc Spring with Contact Flats

Given:

Disc spring $200 \times 82 \times 12 \text{ mm}$; $l_0 = 16.6 \text{ mm}$
 $h_0 = 4.6 \text{ mm}$; $\delta = 2.439$; $h_0/t = 0.383$

Required:

The spring characteristic and the stresses σ_{II} and σ_{III}

Although this spring is to our works standard we show below how the calculations are made and results can be checked in the tables section 9.2.

From the formula 3 to 5 we first calculate the constants K_1 to K_3 :

$$K_1 = 0.755$$

$$K_2 = 1.315$$

$$K_3 = 1.541$$

The static design can be checked by the calculation of σ_{OM} , the reduced thickness is not considered and we use the values of t and h_0 . This gives:

$$\sigma_{OM} = -1579 \text{ N/mm}^2$$

As the acceptable value for σ_{OM} is 1600 N/mm^2 , the spring is correct. From figure 6 and considering d and h_0/t the reduction factor t'/t can be obtained:

$$t'/t = 0.958$$

Therefore $t' = 11.5 \text{ mm}$ and $h_0' = 5.1 \text{ mm}$.

Constant K_4 can be calculated from formula 6:
 $K_4 = 1.0537$

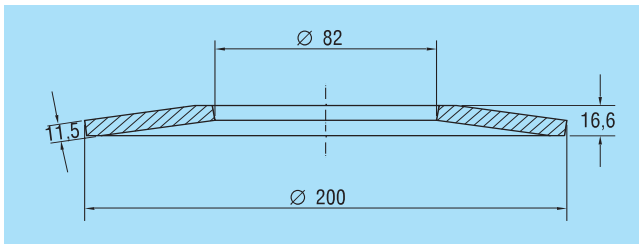

Figure 15
 Disc spring
 $200 \times 82 \times 12 \text{ mm}$

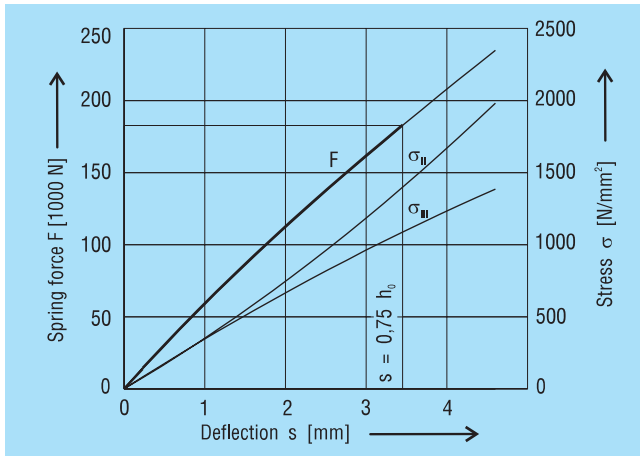

Figure 16
Spring force and stresses
for spring 200 x 82 x
12 mm,
 $t' = 11.5$ $l_0 = 6.6$ mm

Now from formula 8b, 11 and 12 the spring force and both stresses can be calculated:

s/h_0	s [mm]	F [N]	σ_{II} [N/mm ²]	σ_{III} [N/mm ²]
0.25	1.15	66924	416	389
0.5	2.3	127191	890	747
0.75	3.45	182737	1421	1072
1.0	4.6	235503	2011	1366

With this spring the greater values of stress are on the inner diameter which should be used. Finally the value of the stress σ_{OM} for the reduced thickness can be checked:

$$\sigma_{OM}' = \sigma_{OM} \cdot K_4 \cdot t'/t$$

$$\sigma_{OM}' = -1595 \text{ N/mm}^2$$

Design and Operation Limits

Chapter 2



2.1 Allowable Stress for Static or Quasistatic Loads	31
Static Design	31
Permissible Stress	31
2.2 Permissible Stress for Dynamic Loads	31
Critical Stress Affecting Dynamic Failure.....	32
Minimum Preload to Prevent Superficial Cracks	32
Permissible Stress	33

2.1 Allowable Stress for Static or Quasistatic Loads

Static Design

- Static or rarely changing loads exist when:
- Disc springs carry only static, non-changing loads
 - Disc springs are subject to occasional load changes at greater time intervals and less than 10,000 load cycles during the planned service life.

Disc springs are normally designed with an overall height l_0 , so that they can be flattened under static or rarely changing loads without the overall height l_0 reducing by more than the permissible tolerance. The stress σ_{OM} at point OM defined in formula 9 applies here.

Permissible Stress

Plastic deformations occur, when the stresses in certain areas exceed the yield strength. Reference stress is σ_{OM} . Its value should not exceed the tensile strength R_m of the material used. For spring steel as per DIN EN 10132-4 and DIN 17221 the tensile strength is $R_m \approx 1600 \text{ N/mm}^2$. For other materials, the respective applicable yield point values must be used. Disc springs as per DIN 2093 and our factory standards listed in the tables in

chapter 9 were designed according to an earlier method using the stress at point I.

For this reason, some of these springs exceed the permissible stress at the point OM. As these springs have been manufactured for years with this overall height l_0 , we have not changed the height. With these types of springs there is the possibility of slight setting in use.

2.2 Permissible Stress for Dynamic Loads

Dynamic loads occur in disc springs when the load continuously changes between a preload deflection s_1 and a deflection s_2 . Under the influence of a change in stress of σ_n , dynamically loaded disc springs can be divided into two groups by service life (see also DIN 50100):

- Disc springs with longer life. These disc springs are intended to withstand load cycles of at least $2 \cdot 10^6$ and more without

breaking. If a considerably longer life is required, please consult us. It may be that only an endurance test can provide exact information.

- Disc springs with a limited service life. These disc springs are intended to achieve a limited number of load cycles in the range between $10^4 \leq N < 2 \cdot 10^6$ before failure.

Critical Stress Affecting Dynamic Failure

For disc springs carrying dynamic loading, the calculated tensile stress on the underside of the spring are the determining factors, as fatigue cracks always start here. In dependency on the dimensional ratios $\delta = D_o/D_i$ and h_o/t and the relative deflection s/h_o , the

largest stress range σ_h may occur at both point II and point III. Whether point II or point III is decisive can be derived figure 17 for springs with and without contact flats.

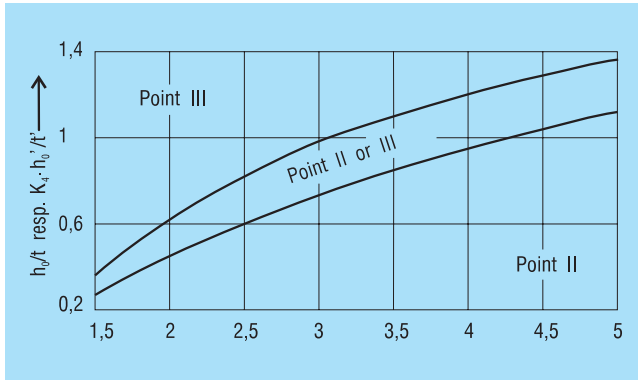

Figure 17
Decisive point of cross-section to be used to determine fatigue life

We recommend calculating the stress for both points using formulas 11 and 12. Use the larger value to determine fatigue life using the

applicable diagrams (figure 18 – 20).

Minimum Preload to Prevent Superficial Cracks

After heat treatment all disc springs are going to be scragged or prestressed, which causes a plastic deformation in the region of cross-sectional point I (see section 4.4). This results in residual tensile stress at this point in the unloaded spring. When loaded there is then a change from tensile to compressive stress

which can result in the formation of cracks during dynamic loading. To avoid these the tensile stress must be balanced out by applying a suitable prestress. Therefore, dynamically loaded disc springs should be preloaded to at least $s = 0.15$ to $0.20 h_o$.

Permissible Stress

The stress calculated for the working range of the spring is compared with the fatigue diagrams in figure 18 – 20. These provide standard values of the permissible stress range σ_H for $N \geq 2 \cdot 10^6$, $N = 5 \cdot 10^5$ and $N = 10^5$ load cycles in dependency on the minimum stress σ_U for dynamically loaded, non-shot-peened disc springs. Intermediate values for other load cycles can be estimated.

A fatigue diagram is indicated for each of the 3 manufacturing groups as per DIN 2093. These groups are divided by the disc thickness as follows:

- Group 1: t less than 1.25 mm
- Group 2: $t = 1.25$ to 6 mm
- Group 3: t over 6 to 14 mm

These diagrams were developed from laboratory tests on test machines with an even sinusoidal load by means of statistical evaluation, whereby a survival rate of 99% was assumed. This means that for a large enough sample a failure rate of 1% can be expected due to fatigue.

The diagrams are applicable to single springs and spring stacks with up to 10 single springs stacked in series, operating at room temperature with hardened and perfectly finished inner or outer guides and minimum preload deflection of $s_1 = 0.15$ to $0.20 h_0$ (page 32).

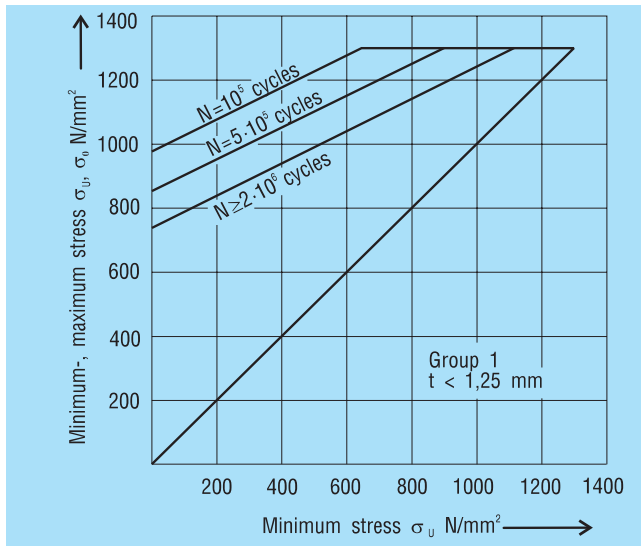

Figure 18
Fatigue resistance diagram for group 1

It should be noted that in practice the type of loads applied in many cases deviates from a nearly sinusoidal frequency. In the case of an impact-type load cycle and as the result of natural frequencies, the actual material load-

ing is considerably greater than the calculated value. The values of the diagrams may only be used for these types of loading under inclusion of the appropriate safety factors.

Design and Operation Limits

For disc springs of materials others than those specified in DIN 2093, for spring stacks with more than 10 or with multiply parallel-stacked individual springs, and in the case of other unfavourable influences of a chemical

or thermal nature, sufficient data to predict fatigue are not yet available. In such cases additional safety factors must also be applied and we recommend that you consult us.

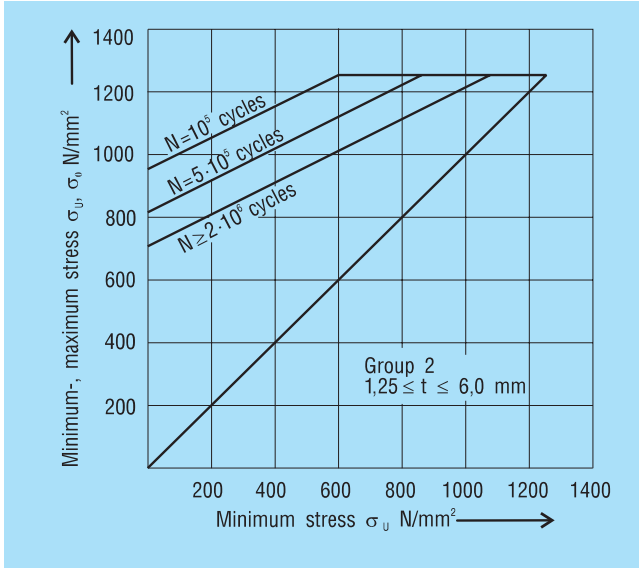

Figure 19
Fatigue resistance
diagram for group 2

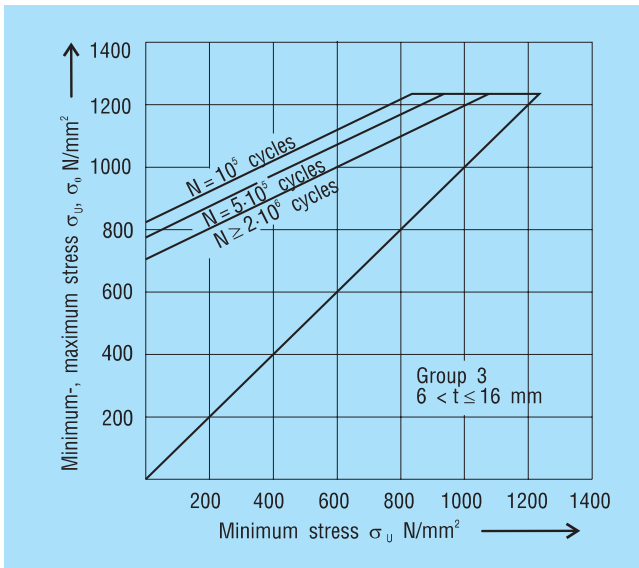

Figure 20
Fatigue resistance
diagram for group 3

Possible Combinations

Chapter 3



Possible Combinations

3.1 Possible Combinations of Single Springs	37
3.2 Stacks in Series	37
3.3 Stacks in Parallel	38
3.4 Stacks from Spring Sets	38
3.5 Progressive Spring Characteristics	39

3.1 Possible Combinations of Single Springs

The shape of the disc spring as a conical disc allows single springs to be combined in different ways. As a result, the characteristic of a spring combination can be varied in almost any way desired and adapted to the requirements. In principle the following possibilities exist (figure 21):

- Single-series spring stack (series stacking)
- Parallel springs in spring sets (parallel stacking)
- Spring stack of parallel sets in series

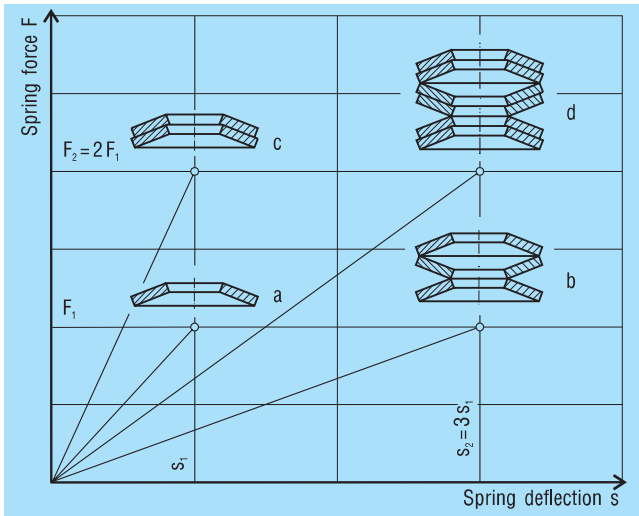

Figure 21 Schematic representation of characteristic lines possible with springs of the same size in different combinations

The determination of the characteristic for assembled disc spring stack is based on the

characteristic of the single spring (figure 21, chart a).

3.2 Stacks in Series

A stack of “i” springs in single series (figure 21, chart b) results in the following without considering friction:

Only the deflection is multiplied by the number of springs in series, not the load.

Spring Load:

Formula 17

$$F_{ges} = F$$

Spring Deflection:

Formula 18

$$s_{ges} = i \cdot s$$

Unloaded Stack Length:

Formula 19

$$L_0 = i \cdot l_0$$

3.3 Stacks in Parallel

A set of “n” single springs in parallel (figure 21, chart c) results in the following without considering friction

Spring Load:

Formula 20

$$F_{ges} = n \cdot F$$

Spring Deflection:

Formula 21

$$s_{ges} = s$$

Unloaded Set Height:

Formula 22

$$L_0 = l_0 + (n - 1) \cdot t$$

In this case the spring load must be multiplied by the number of springs in parallel, where as the deflection remains as for a single spring. For springs in Group 3 with contact flats and reduced disc thickness, t must be replaced with t' in formula 22.

3.4 Stacks from Spring Sets

This is the combination of parallel sets in series (figure 21, chart d). For “i” sets in series and “n” springs in parallel following results without considering friction:

Spring Load:

Formula 23

$$F_{ges} = n \cdot F$$

Spring Deflection:

Formula 24

$$s_{ges} = i \cdot s$$

Unloaded Stack Length:

Formula 25

$$L_0 = i \cdot [l_0 + (n - 1) \cdot t]$$

With this arrangement the spring load is proportional to the number of disc springs in parallel, while the deflection is proportional to the number of sets. In formula 25 t must be replaced with t' if necessary.

3.5 Progressive Spring Characteristics

In many cases it is a requirement that the spring load increases progressively as the deflection increases, i.e. the rate of the characteristic increases instead of (as it is typical for disc springs) decreasing (figure 22). Such characteristic curves can be achieved in various ways.

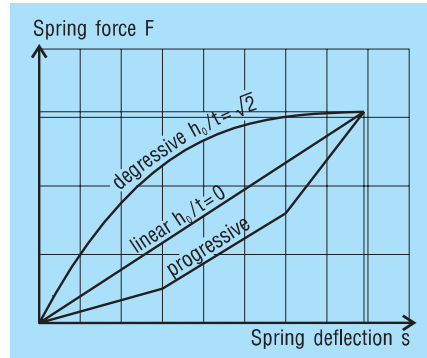

Figure 22
Various types of spring characteristics

With a spring stack as shown in figure 23, chart a, the discs of the 1, 2 and 3-fold layering will be flattened in sequence when a load is applied. The characteristic of such a spring stack results in the addition of the individual characteristics, as shown schematically in figure 23. The same results can be achieved by combining springs of different thickness to form a stack (figure 23, chart b).

In this case it must be considered that the spring sets stacked 1 or 2-fold or the thinner single discs are subjected to very high stresses if disc springs as per DIN 2093 or the SCHNORR Factory standard have been selected. However, this overloading can be prevented with a smaller cone height or with spacer sleeves or rings to limit the deflection.

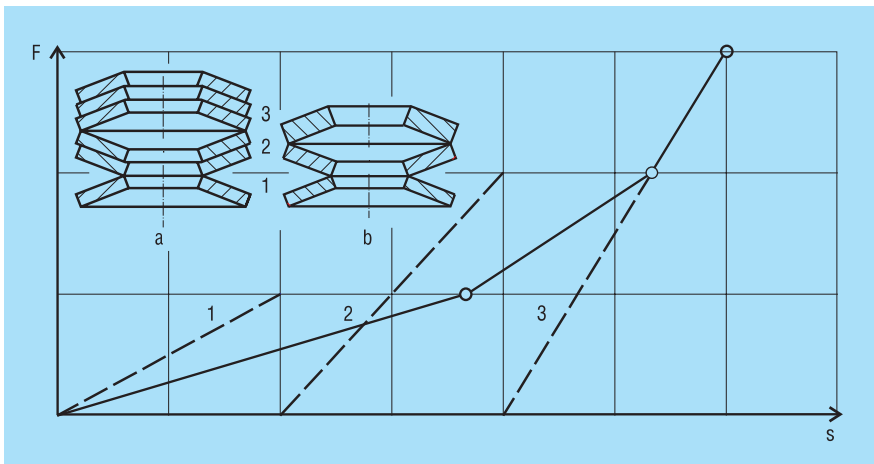

Figure 23
Progressive characteristic with disc springs

Possible Combinations

Other ways of obtaining a progressive characteristic are shown in figures 24 to 26. By inserting intermediate rings of differing thicknesses, the deflection of a spring stack consisting of disc springs of the same thickness can be limited in steps. As a result, the spring rate increases with increasing deflection (figure 24). Care must be taken to ensure that the permissible stress is not exceeded for springs without spacer rings (section 3 of the stack).

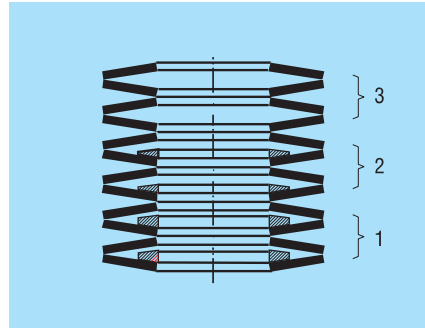

Figure 24
Spring arrangements for a progressive characteristic

A progressive characteristic can also be obtained by combining disc springs with flat washers. With this arrangement as shown in figure 25, the disc springs of a group of 2 disc springs with a flat washer between them first deflect until they all 3 parts lie parallel. From this point on the two disc springs act as a parallel pair and the flat washer is unloaded again, as it moves toward its original state.

Washers and disc springs may also have different thicknesses or be arranged so that 3 or more layers result.

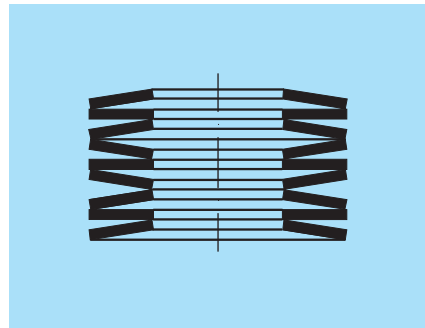

Figure 25
Spring arrangements for a progressive characteristic

Figure 26 shows a stack consisting of disc springs of 3 different thicknesses. Here external rings are used as spacers to limit the deflection to protect the thinner springs from overloading.

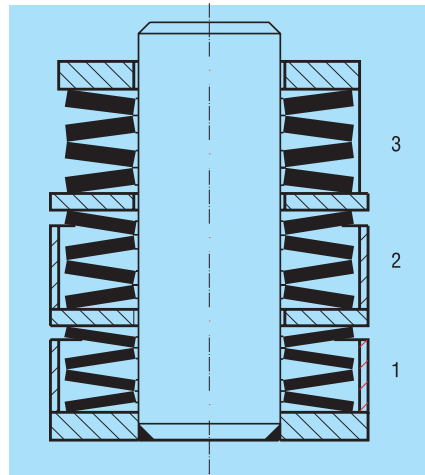

Figure 26
Spring arrangements for a progressive characteristic

If you should have a requirement for similar spring arrangements, please consult our Technical Consulting Service. We will be glad to make the appropriate calculations for you.



Chapter 4

Manufacture

- 4.1 Classification by Group 43**
- 4.2 Fine Blanked or Turned Disc Springs? 43**
- 4.3 Heat Treatment 45**
- 4.4 Scragging or Presetting 45**
- 4.5 Shot Peening 45**
- 4.6 Corrosion Protection 46**
 - Phosphating 46
 - Browning..... 46
 - Metallic Surface Treatment..... 46
 - Zinc 46
 - Cadmium..... 46
 - Nickel 46
 - Electroplating 47
 - Mechanical or Peen Plating 47
 - Metal Spray 47
 - Chemical Nickel Plating 47
 - Dacromet Coating 47

4.1 Classification by Group

The large dimensional range in which disc springs are made requires very different production methods. The methods employed range from simple stamping and stamping with extra machining to hot forged and rolled rings, which are turned or ground to obtain their final shape.

DIN 2093 specifies 3 manufacturing groups:

Group 1: Thickness t less than 1.25 mm

Group 2: Thickness t from 1.25 to 6 mm

Group 3: Thickness t more than 6 to 14 mm

For these groups the following manufacturing methods are specified:

- Group 1:
- Stamped,
 - Cold formed,
 - Corners rounded

- Group 2:
- Stamped,
 - Cold formed,
 - D_e and D_i turned,
 - Corners radiused

- Group 3:
- Cold or hot formed,
 - Machined all over,
 - Corners radiused,
 - With contact flats and reduced thickness

All SCHNORR disc springs as per DIN 2093 and our factory standards are made to these requirements. Special sizes are also assigned to the appropriate group if production is possible or no other production method has been agreed upon. The manufacturing process is shown schematically for the three groups in figure 27.

4.2 Fine Blanked or Turned Disc Springs?

For group 2 manufacture the standard allows the following alternative:

- Fine blanked
- Cold formed
- Corners rounded

The machining method is left to the manufacturer's discretion, **unless it is expressly specified by the customer**. This means that the user can specify which version is to be supplied!

The group 2 springs we deliver are exclusively turned on the inside and outside diameter, as we still consider this the best method. During turning the unavoidable

machining grooves result in the circumferential direction, and thus lie in the same direction as the maximum stress, whereas stamping grooves (which also result during fine blanking!) run at a right angle to the maximum stress, which leads to a much lower impact strength^[11].

If fine-cut springs are required to reach the life expectancy laid down in DIN 2093, there is clear evidence that these turned springs are more suitable for the highest demands.

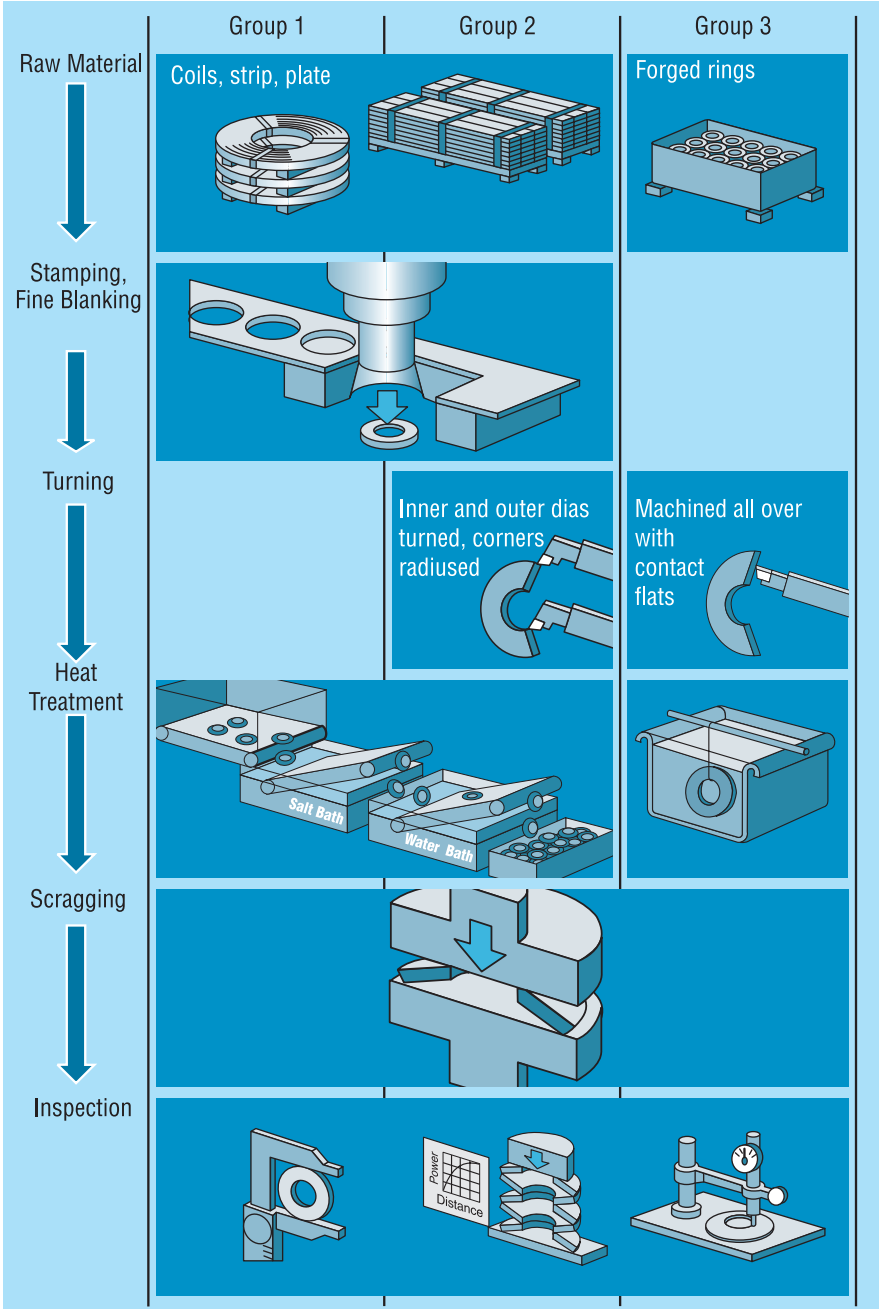

Figure 27
The manufacturing process of several groups

4.3 Heat Treatment

Heat treatment is of major importance for properties of a spring. Therefore, we heat treat all springs of ordinary spring steel – as long as they are not manufactured of spring-hard material – using an isothermal annealing. This enables a so-called bainite stage to ensure that the springs attain the highest

strength, and at the same time a high degree of toughness and optimal fatigue resistance.

According to DIN 2093 the hardness of disc springs should be 42 – 52 HRC. With the springs we manufacture, hardness is related inversely to disc thickness.

4.4 Scragging or Presetting

After heat treatment each spring is flattened at least once. This reduces the overall height by means of plastic deformation. Tensile stress results on the upper side, which counteracts the compressive stress caused by subsequent loadings and so reduces the stress peaks. Further plastic deformation is

thereby avoided during later loading of the spring.

According to DIN 2093 each disc spring must be scragged so that following loading equivalent to twice the spring force $F_{(s = 0.75 h_s)}$, the limit deviations for the spring force are not exceeded.

4.5 Shot Peening

It has been shown that shot peening can be very beneficial to springs subjected to dynamic loads. It can considerably improve the working life far in excess of the values shown in figures 18, 19 and 20. Shot peening produces compressive stress at the surface

which partially counteracts internal tensile stress resulting from setting. Therefore shot-peened springs will generally set more than usual. For this reason, surface bonding by means of shot peening is not recommended for springs carrying static loads.

4.6 Corrosion Protection

In practice the presence of corrosive media is so common and the forms of attack so numerous that it is not possible to deal with the entire problem in detail here. We must refer you to the literature in the supplement. It can only be established here that ordinary spring steel must offer no corrosion protection of their own. Therefore, disc springs of these types of steel must be protected against

Phosphating

This is the standard process generally applied to all low alloy steels unless otherwise agreed. A zinc phosphate layer is produced on the surface, which is then impregnated with corrosion-protection oil. The protection achieved in this way is sufficient in the vast majority of all cases. Primarily for inside

Browning

This process simply produces an oxidised surface, which is then coated with a corrosion-resistant oil. The corrosion resistance is not as good as phosphating, therefore this

corrosion with a suitable surface treatment.

A wide range of methods are available for this purpose from which the best suited must be selected for each individual case. More information on corrosion-resistant steel can be found in section 7.3.

The most important surface treatment methods are:

applications, but a Iso out of doors, if the springs are installed with weather protection, no additional protection is required.

According to DIN 50960, the designation for phosphate treatment is: Surface coating as per DIN 50942 Fe/Znph r10 f.

treatment is mostly used where a phosphate coating or its abrasion is a problem.

DIN 50960 defines browning as follows: Surface coating as per DIN 50938 Fe/A f.

Metallic Surface Treatment

Metals for Surface Treatment

- **Zinc** is by far the most commonly used coating metal. As it lies lower than steel in the electrochemical series at room temperature, it forms a so-called cathodic protection and is attacked first by corrosion. With a chromated surface the onset of corrosion can be significantly delayed. The most effective is yellow chromating, which should always be chosen over clear chromating.

- **Cadmium** also offers very good corrosion protection, but is only rarely used now for environmental protection reasons.

- **Nickel** is resistant to a large number of media and is frequently used as a coating metal. It is placed higher than steel in the electrochemical series, i.e. in the case of the formation of a local element (e.g. at a damaged point in the nickel coating) nickel acts as a cathode and the base metal is attacked. For this reason the nickel must always be a dense, non-porous coating.

Electroplating

With electroplating virtually any metal can be precipitated as a surface coating. However, when treating high-tensile steels – such as those always used for disc springs and lock washers – the danger of hydrogen embrittlement cannot be excluded with the current state of technology. Post plating bake is also no guarantee that this risk is completely

eliminated. Therefore, we only use electroplating if it is specified as mandatory or there is no other alternative.

Designation of a galvanically produced 8 µm thick zinc coating with transparent chromating is: Surface coating as per DIN 50961 Fe/Zn 8 cB.

Mechanical or Peen Plating

With this process the parts to be treated are moved in a barrel together with peening bodies, e.g. glass beads, and a so-called promoter and the coating metal (preferably zinc) is added in powdered form. This powder is deposited on the surface and is compacted by the peening bodies. An even, mat coating results, which can then be chromated like a

galvanic coating. The usual layer thickness is 8 µm, however thicknesses of up to 40 µm are possible. It is of particular importance that no hydrogen embrittlement can occur when the process is carried out properly.

Designation of a mechanically applied 8 mm thick zinc coating with yellow chromating is: Surface coating mech Zn 8 cC.

Metal Spray

This treatment is primarily for disc springs with diameters above 150 mm which cannot be mechanically zinc plated. As a rule, sprayed zinc coatings are relatively thick and have a granular surface which also makes them

excellently suited as a base for paints. However, the adhesion is inferior to mechanical zinc coating and it may become delaminated during dynamic loading.

Chemical Nickel Plating

With this treatment, also known as “electroless nickeling”, a nickel-phosphor alloy is precipitated onto the surface with a chemical method. This results in a thick, hard layer

with sharp contours and outstanding corrosion and abrasion resistance. The coating is usually applied in layers with a thickness of 15 – 30 µm.

Dacromet Coating

This is an inorganic silver-grey metallic coating of zinc and aluminium flakes in a chromatic compound. The parts are treated in a barrel or on racks and the coating then baked on at over 280°C. Dacromet-treated springs

exhibit excellent resistance in a salt spray test. With the usual processing technology there is absolutely no possibility of hydrogen embrittlement.

Tolerances

Chapter 5



5.1 Diameter Tolerances	51
5.2 Thickness Tolerances	52
5.3 Overall Height Tolerances	52
5.4 Load Tolerances	52
Single Disc Springs.....	52
Spring Stacks.....	53
5.5 Permissible Setting	54

Disc Springs Tolerances

The following maximum deviations are laid down in DIN 2093. They are valid for all SCHNORR disc springs as per the DIN and our works standards. In general we also apply these tolerances to special sizes, however, if they deviate greatly from the DIN springs, wider tolerances must be specified.

This applies, for example, to our ball-bearing disc springs (section 8.1 and 9.5). If closer tolerances are required than those specified in DIN 2093, please consult us.

5.1 Diameter Tolerances

For the outside diameter D_e , the tolerance field h12 is applied, and for the inner diameter D_i it is H12.

For the concentricity the tolerances applied are:
 for D_e to 50 mm: 2 · IT 11
 for D_e over 50 mm: 2 · IT 12

D_e or D_i [mm]	Permissible deviation in mm		
	D_e	D_i	Concentricity
over 3 to 6	0 / -0.12	+0.12 / 0	0.15
over 6 to 10	0 / -0.15	+0.15 / 0	0.18
over 10 to 18	0 / -0.18	+0.18 / 0	0.22
over 18 to 30	0 / -0.21	+0.21 / 0	0.26
over 30 to 50	0 / -0.25	+0.25 / 0	0.32
over 50 to 80	0 / -0.30	+0.30 / 0	0.60
over 80 to 120	0 / -0.35	+0.35 / 0	0.70
over 120 to 180	0 / -0.40	+0.40 / 0	0.80
over 180 to 250	0 / -0.46	+0.46 / 0	0.92
over 250 to 315	0 / -0.52	+0.52 / 0	1.04
over 315 to 400	0 / -0.57	+0.57 / 0	1.14
over 400 to 500	0 / -0.63	+0.63 / 0	1.26

5.2 Thickness Tolerances

Tolerances allowed in DIN 2093 are as follows:

	t or t' [mm]	Tolerance for t [mm]
Group 1	0.2 to 0.6	+0.02/-0.06
	> 0.6 to < 1.25	+0.03/-0.09
Group 2	1.25 to 3.8	+0.04/-0.12
	> 3.8 to 6.0	+0.05/-0.15
Group 3	> 6.0 to 16.0	+0.10/-0.10

For springs in group 3 the tolerance is applied to the reduced thickness t' .

We use the thickness to ensure that spring loads are within tolerance and therefore will in some cases deviate from the above figures.

5.3 Overall Height Tolerances

	t [mm]	Tolerance for l_0 [mm]
Group 1	< 1.25	+0.10/-0.05
Group 2	1.25 to 2.0	+0.15/-0.08
	> 2.0 to 3.0	+0.20/-0.10
	> 3.0 to 6.0	+0.30/-0.15
Group 3	> 6.0 to 16.0	+0.30/-0.30

To ensure the specified spring forces, DIN 2093 allows the overall height tolerance to be slightly exceeded.

5.4 Load Tolerances

Single Disc Springs

For single disc springs the following maximum deviations are allowed:

	t [mm]	Tolerances for F at the test length $l_p = l_0 - 0.75 h_0$
Group 1	< 1.25	+25 % /-7.5 %
Group 2	1.25 to 3.0	+15 % /-7.5 %
	> 3.0 to 6.0	+10 % /-5 %
Group 3	> 6.0 to 16.0	+5 % /-5 %

With a single spring the spring force must be checked at the height $l_0 - s$. This should be carried out with the spring pressed between two lubricated, hardened, ground and polished plates. Measurements are always taken in loading direction.

For the determination of the variation between loading and unloading, a stack of 10 springs in single series is used. The stack is fitted with a guide rod as described in section 6.3 and abutment plates inserted at both ends as per section 5.4. Before testing, the

stack should be loaded with twice the spring force $F_{(s = 0.75 h_0)}$.

During unloading the measured spring force at the length $L_0 - 7.5 h_0$ must at least reach the percentage of the loading characteristic shown in the table (figure 28).

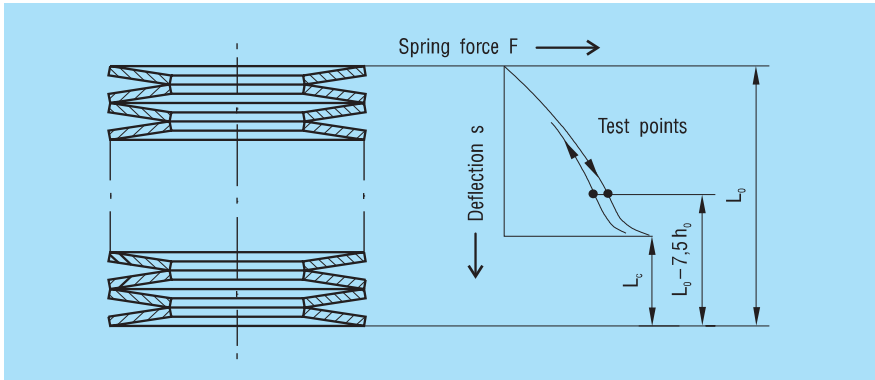

Figure 28
Test points on the loading/unloading characteristic curve

	Series A	Series B	Series C
Group 1	min. 90%	min. 90%	min. 85%
Group 2	min.92.5%	min.92.5%	min.87.5%
Group 3	min. 95%	min. 95%	min. 90%

5.5 Permissible Setting

All springs experience a loss of load or relaxation in the course of time, which is primarily dependent on the occurring stress and the temperature-time curve. For disc springs the stress distribution in the cross-section also plays a role determined by the dimensional relationships δ and h_0/t . The relaxation can therefore be related to stress σ_{OM} , because it best reflects all other influences. Depending on the installation situation, the load loss may occur as creeping or

relaxation. Creeping is described as a loss of length Δl which the spring suffers under a constant load F , and relaxation as a loss in load ΔF if the spring is installed at a constant length l . Approximate values for the permissible relaxation of disc springs under static loads are provided in figure 29 and 30. If working temperatures above 100°C occur, we recommend you contact our Technical department.

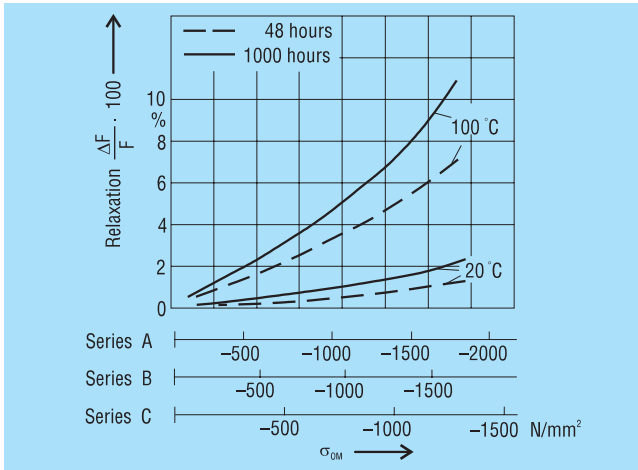

Figure 29
Permissible relaxation
for disc springs of
Ck steel

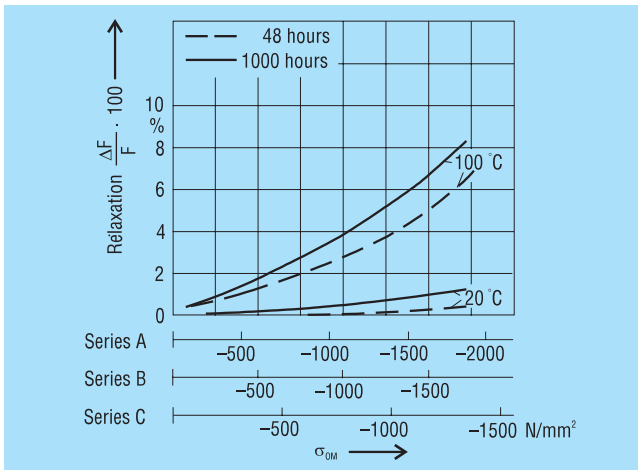

Figure 30
Permissible relaxation
for disc springs of
chrome and chrome-
vanadium-alloy steel as
per DIN EN 10132-4 and
DIN 17221



Chapter 6

Application

6.1 Spring Stacks and their Features	57
6.2 Alignment of Spring Stacks	57
6.3 Guide Clearance	58
6.4 Guide Elements and Abutments	59
6.5 Friction	60
Causes of Friction	60
The Magnitude and Factors Influencing Friction	61
Calculation of Friction as per DIN 2092	62
Lubrication	64
The Effects of Friction	64

6.1 Spring Stacks and their Features

The best spring arrangement is the one which uses the least number of individual springs. In order to achieve this goal, the outside diameter should always be as large as possible. This automatically keeps the stack length short.

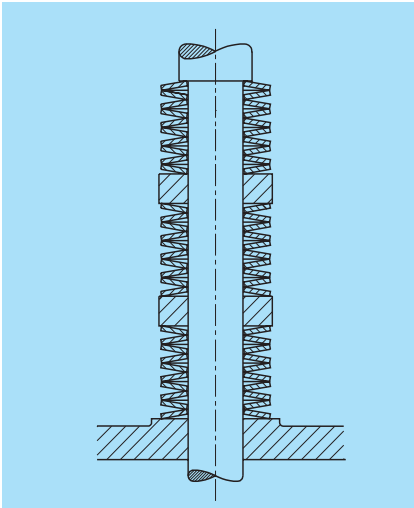

Figure 31
Division of a long spring stack

With an increasing number of disc springs, the friction and the uneven deflection of individual discs within the stack increases. We recommend $L_0 \leq 3 \cdot D_0$ as the approximate stack length. If it is not possible to avoid a longer stack, then it should be divided into 2 or possibly 3 partial stacks with suitable washers. These washers should be guided as exactly as possible (figure 31).

In order to keep the friction within reasonable limits, no more than 2 or 3 springs should be stacked in parallel unless a large friction loss is expressly desired. Particularly in the case of dynamic loading, considerable warming must be expected with 2 or more springs in parallel. Whenever possible, the abutments of a disc spring stack should contact the outside diameter, however this is only possible at both abutments with an even number of individual springs or spring sets.

6.2 Alignment of Spring Stacks

Within a spring stack the disc springs do not always move evenly (figure 32).

This naturally leads to overloading at one end of the stack with consequential reduction in fatigue life. This is also the reason why, with dynamic loads, the first breaks occur at an end of the spring stack in most cases. Therefore, we recommend that the spring stack be aligned on the guide rod with a “vee bar” and then maintained in position with a light preload. After alignment the spring stack should not be completely relaxed. This procedure has been found most satisfactory in practice for minimizing friction in spring stacks. If it is not possible to

align the stack for design reasons, the stack should be compressed flat once or twice. This also has the effect of centralising the springs and reducing friction.

The friction is usually somewhat less in a vertically arranged stack than in the horizontal installation position. It is therefore better to have long stacks arranged vertically rather than horizontally.

With a dynamically loaded stack there is a running in period during which the friction is reduced, especially with multiple layering. The reason for this is a certain smoothing effect at both the contact edges and the touching spring flanks.

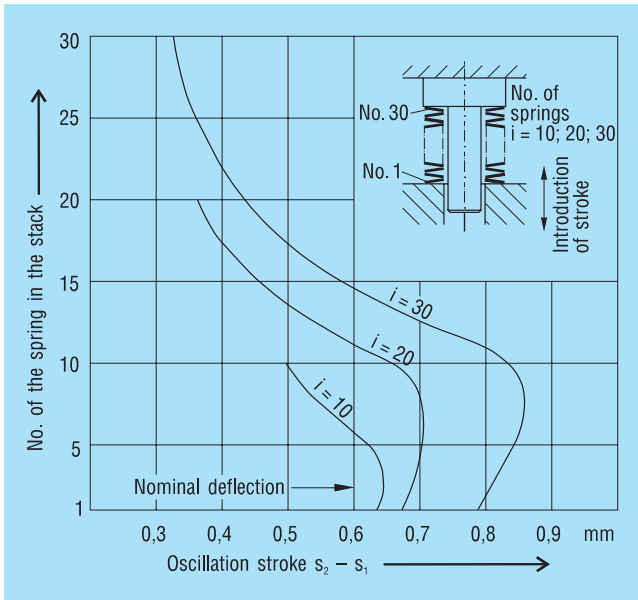

Figure 32
Example of the uneven deflection within a spring stack

6.3 Guide Clearance

Disc springs always need a guide element to prevent lateral movement. The guide can be on the outside D_e or the inside D_i of the springs, but inside guidance on a bolt or shaft is preferred to the outside guidance in a sleeve, because it offers design and economic advantages.

For the clearance between the guide and the spring DIN 2093 recommends the following values.

D_i or D_e	Clearance
to 16 mm	0.2 mm
over 16 to 20 mm	0.3 mm
over 20 to 26 mm	0.4 mm
over 26 to 31.5 mm	0.5 mm
over 31.5 to 50 mm	0.6 mm
over 50 to 80 mm	0.8 mm
over 80 to 140 mm	1.0 mm
over 140 to 250 mm	1.6 mm

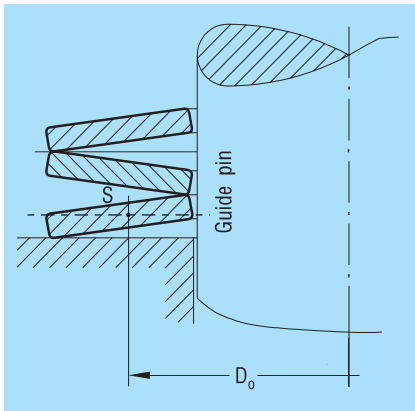

Figure 33
With the rectangular spring cross section jamming at the guide pin during deflection is prevented

On compression the spring cross-section turns about a centre of rotation S on the diameter D_0 (figure 33). If in the unloaded condition the contact point of the spring on the guide is below a horizontal through point S , there is no reduction in the inside diameter. The same holds true for an outside guide where the contact point is above the horizontal. For springs with a ratio of $h_0/t > 1$ this is not always the case and a reduction of the inner

These values represent the difference in the diameters. Under certain conditions this guide clearance can be reduced, e.g. with high-speed spindles.

In order to avoid jamming of the individual disc springs on the guide bolt or in the guide sleeve, the spring cross-sections must be designed to be rectangular (figure 33). All four corners are slightly rounded with a radius of approximately $t/8$.

diameter must be expected. However, this reduction is mostly very small and with standard springs is covered by the guide clearance laid down in table on page 58. The calculations to determine the variations in the diameter are very easy today and we recommend you contact our Technical department if you require additional information on this subject.

6.4 Guide Elements and Abutments

The guide elements and abutments should be hardened if possible to a minimum of 55HRC and a minimum case depth of 0.8 mm. The surface of the guide rod should be smooth and, if possible, ground. For dynamic applica-

tions we recommend lubrication with a high pressure grease containing MoS_2 . For static applications guides may be unhardened.

6.5 Friction

Due to friction, the actual loads obtained when loading and unloading the spring stack may deviate from the figures calculated. These variations are in many cases inconvenient, but at times required for application reasons.

Causes of Friction

The total friction with disc spring stacks arises because of 4 different components (figure 34):

1. The internal friction through elastic deformation of the material. It occurs with each deflection of the material and cannot be altered.
2. Friction on the end abutments through the radial movement between the spring and the abutment surface. This only occurs with the end springs in the stack, as there is no relative movement between the other springs to each other.
3. Friction of the springs on the guide due to axial movement of the springs during deflection.
4. Friction between springs in the case of parallel stacking.

The first three types of friction occur with single springs and single series spring stacks. It is therefore a fact that friction with disc springs is always greater than with coil springs.

Therefore, it is often necessary to calculate the friction and take this into consideration.

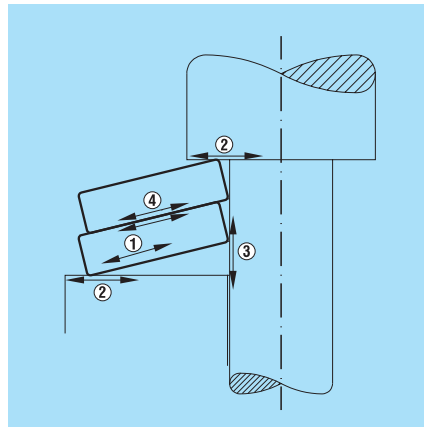

Figure 34
Friction in disc springs

The Magnitude and Factors Influencing Friction

The amount of friction depends on very many factors:

Geometric factors:

- Shape of the cross section
- Radii on the corners
- Amount of guide clearance
- Surface roughness of the springs and guide elements

Material factors:

- Material of the springs and guide elements
- Hardness of the springs and guide elements
- Surface protection of the springs
- Type of lubricant

Assembly factors:

- Number of parallel stacked springs
- Length of the spring stack

Load dependant factors:

- Length of spring stroke
- Speed of loading (frequency)

The value of the different factors on the total friction varies considerably from case to case and we can only give the following indications:

The geometric factors have already been mentioned in section 6.3. A frequently underrated influence is the surface treatment. For example, zinc plated springs have less friction than those phosphated. With parallel stacking the greatest friction is between the springs, with an increase in proportion to the number of parallel springs. This can, however,

be reduced by means of a suitable grease (see page 64).

It is known from experience that relatively large deflection s/h_0 or $(s_2 - s_1)/h_0$ cause more friction than smaller deflections. These factors should all be considered for high frequency spring applications. Because of the large number of influences, it is not possible to derive an exact calculation for friction in disc spring stacks.

However, from many tests with various spring sizes a figure has been derived of $\pm 2.5\%$ per parallel spring (+ loading, - unloading). This results in the following values:

Influence of friction on spring load

1 single spring	$\pm 2... 3 \%$
2 in parallel	$\pm 4... 6 \%$
3 in parallel	$\pm 6... 9 \%$
4 in parallel	$\pm 8... 12 \%$
5 in parallel	$\pm 10... 15 \%$

Figure 35 shows the principal load variations for one to 4 springs in parallel.

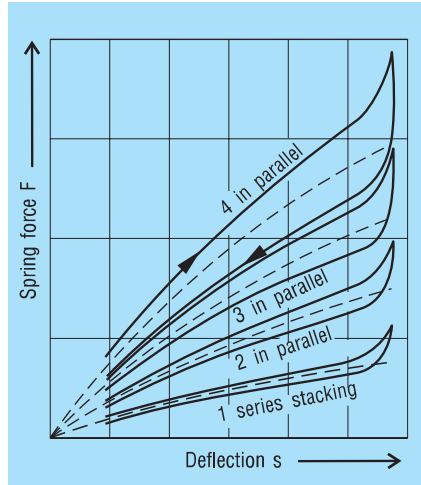

Figure 35
Influence of friction on spring force for various parallel stackings

Calculation of Friction as per DIN 2092

DIN 2092, Issue 1/92 gives a method of calculating the friction F_R on spring load. This omits the internal friction and the friction on the guide rod (section 6.5 Nos. 1 and 3). This must be obtained through an additional calculation. The values below for surface and edge friction to DIN 2092 give a relatively wide range.

Therefore, it is our opinion that, although this process is theoretically correct, in the end it does not provide any better results than the consideration of the friction with a simple, percentile addition. For completeness we have shown this calculation method below.

The following formula applies:

Formula 26

$$F_{gesR} = F \frac{n}{1 \pm w_M(n-1) \pm w_R}$$

Where:

- F = Calculated spring load to formula 7
- n = Number of springs in parallel
- w_M = Coefficient of surface friction
- w_R = Coefficient of edge friction
- = On loading
- + = On unloading

With $n = 1$ formula 26 describes relationships for a single spring between 2 flat plates. For the friction coefficients w_M and w_R , DIN 2092 gives the following values:

Series par DIN 2093		w_M	w_R
Series A	0.005...0.030	0.03...0.05	
Series B	0.003...0.020	0.02...0.04	
Series C	0.002...0.015	0.01...0.03	

When calculated with these values, formula 26 provides the following numbers, which are considerably easier to understand:

Alteration of the calculated spring load through the friction is in %.

+ = Increase in load when loading / - = Reduction in load when unloading

	n = 1		n = 2		n = 3	
Series A	+3.09...	+5.26	+3.63...	+8.70	+4.17...	+12.36
	-2.91...	-4.76	-3.38...	-7.41	-3.85...	-9.91
Series B	+2.04...	+4.17	+2.35...	+6.38	+2.67...	+8.70
	-1.96...	-3.85	-2.25...	-5.66	-2.53...	-7.41
Series C	+1.01...	+3.09	+1.21...	+4.71	+1.42...	+6.38
	-0.99...	-2.91	-1.19...	-4.31	-1.38...	-5.66

These results are presented in figure 36.

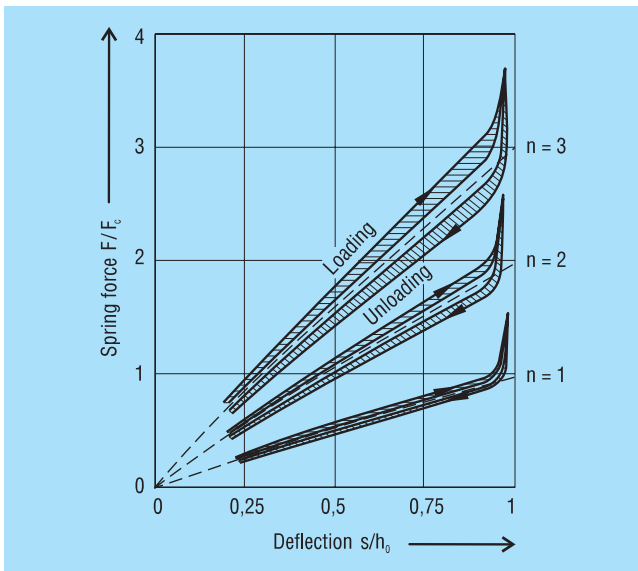

Figure 36
Friction for disc springs
as per DIN 2092

Lubrication

The large variation in figure 36 shows the influence of lubrication on the friction. The choice of the correct lubricant is therefore often of decisive influence. As well as reducing friction, it can prevent galling of one spring on another when stacked in parallel. Similarly, it can help prevent corrosion. The lubricants which may be used are:

- **Oil** is frequently used for springs in machine construction, especially with central lubrication or an assured continuous oil supply.

The Effects of Friction

Friction mainly affects the deflection of the spring, i.e. it modifies the spring loads. It must be added when loading the spring and subtracted when the spring is unloaded. Between the actual loading and unloading curve there is a hysteresis loop. The effect of the number of parallel springs on the hysteresis is shown in figure 35. This frictional work is turned into heat and with high

- **Grease** is more suitable if relubrication is difficult or cannot be done on a regular basis.

- **Slip paints** are based on MoS_2 and are an elegant solution to providing permanent lubrication. It also provides a high degree of corrosion resistance.

frequency dynamic loading this can be considerable. In such cases, single stacked disc springs should be preferred and good lubrication is essential.

With spring energy storage the hysteresis is a total loss and cannot be recovered. However, with springs for damping, this hysteresis effect is useful and the frictional work is a measure of the damping.

Materials

Chapter 7



7.1 General Requirements	67
7.2 Standard Materials	68
C 60S	68
C 67S, C 75S	68
51 CrV 4	68
7.3 Materials for Special Requirements	68
Corrosion Resistant Steels	68
X 10 CrNi 18-8	68
X 7 CrNiAl 17 7	69
X 5 CrNiMo 17 12 2	69
Steels for Higher Temperatures	69
X 22 CrMoV 12 1	69
X 39 CrMo 17-1	70
Copper Alloys	70
CuSn 8	70
CuBe 2	70
Nickel and Cobalt Alloys	70
NIMONIC 90	71
INCONEL X 750 and INCONEL 718	71
DURATHERM 600	71
7.4 Table of Material Properties	72

7.1 General Requirements

The essential of a spring is that it has the quality to react to loading by elastic deformation. Therefore, materials with high elasticity are necessary. As in each case a small design is desired, spring materials should have the highest tensile strength and a high elastic limit.

In addition to high strain in the elastic region, there must also be sufficient plasticity. This allows the manufacture of cold formed springs which will not break through the greatest unforeseen overloading.

Moreover, a high fatigue limit is required which is however not a characteristic value of the material as, for example, the tensile strength. For a high fatigue strength, a high degree of purity, a homogenous structure and a smooth carbon-free surface are pre-supposed.

These requirements are fulfilled very well by steel, therefore most springs are made of steel. Apart from this there will be the requi-

rement in some cases for corrosion resistance, heat resistance or anti-magnetic properties where special materials will be required.

An important property of spring material is Young's Modulus (E). From this material constant is derived a linear relationship between load and deflection. The 'E' of steel is practically not affected by heat treatment, but it is temperature dependent and this must be taken into consideration at higher working temperatures (figure 37).

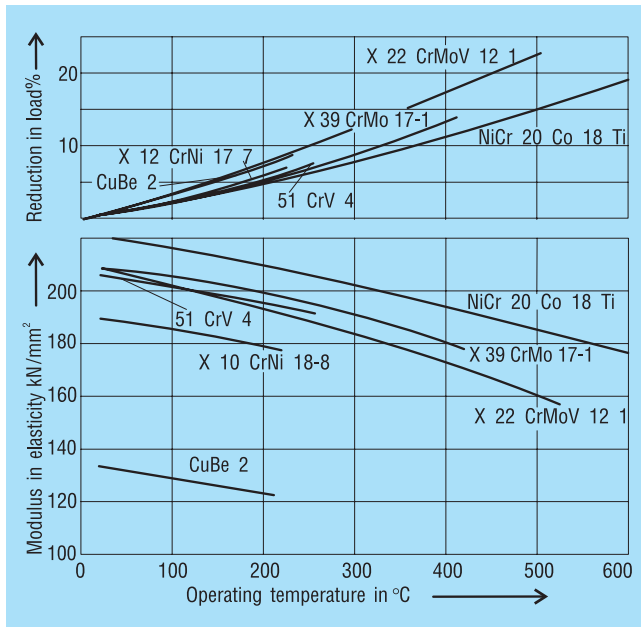

Figure 37
Temperature dependence of 'E' and related reduction in load

Materials for disc springs are principally supplied in the following forms:

- Cold rolled strip as per DIN EN 10140
- Hot rolled strip as per DIN EN 10048
- Plate as per DIN EN10029
- Forgings as per DIN 7521 and 7526

In the tables on pages 72 to 75 list the properties of all the materials from which disc springs are manufactured. The following notes give clarification of this.

7.2 Standard Materials

● **C 60S:** Both types are quality steels as per DIN EN 10132-4. We use them for our Original Schnorr Serrated Safety Washers and Load Washers as per DIN 6796 where the loading is only static.

● **C 67S** and **C 75S:** These high grade steels as per DIN EN 10132-4 are used for cold formed springs to group 1. For lightly loaded springs, for example our “K” springs for preloading ball bearings, these materials can be processed in the spring-hard condition.

● **51 CrV 4** (1.8159): This is a chrome vanadium refined alloy steel of the highest quality. It is available in cold rolled form as per DIN EN 10132-4, hot rolled and forgings as per DIN 17221 for the manufacture of disc springs. It has very good through-hardening capability and is therefore suitable for making springs up to 50 mm thick. The relaxation is less than for non-alloyed steel (see section 5.5), which allows use up to 250°C (with a suitable reduction in load).

7.3 Materials for Special Requirements

Special requirements such as corrosive or high temperature environments often require the use of materials designed for these applications. These materials, in general, have lower tensile strength than standard materials and should only be specified, if absolutely

necessary. These springs have a lower overall height than comparable sizes made of standard materials resulting in lower spring force. This must be taken into consideration using these materials.

Corrosion Resistant Steels

● **X 10 CrNi 18-8** (1.4310): This chrome nickel alloyed steel as per DIN EN 10151 is the material most used for corrosion resistant springs. Because of its austenitic structure with ferritic inclusions, it cannot be hardened in the usual way, but by cold forming it can obtain the strength required for disc springs. Considerable cold forming is necessary and the strength reduces with increasing thick-

ness. Therefore, the material is normally not available thicker than 2.5 mm. In fact, springs can only be supplied to this thickness. Whereas the material in the soft condition is hardly magnetic, the cold working process will make it more or less magnetic again, making it unsuitable for completely non-magnetic springs.

● **X 7 CrNiAl 17 7** (1.4568): This steel as per DINEN 10151 precipitation hardened produces an austenitic/ferritic structure. It will also be processed in the work hardened condition and may be hardened by subsequent heat treatment. A disadvantage compared to steel 1.4310 is the lower corrosion resistance and sensitivity to stress corrosion. We therefore only recommend its use for springs over 2.5 mm thickness if no other material is available.

● **X 5 CrNiMo 17 12 2** (1.4401): The strength of this material is somewhat less than either of the two forging. Notwithstanding that it offers higher corrosion resistance and lowest magnetism. Although also contained in DIN 17224, it is often difficult to obtain and therefore only seldom used.

Steels for Higher Temperatures

When considering springs for use at higher working temperatures it must be remembered that both tensile strength and Young's modulus 'E' are reduced compared with the values at room temperature.

● **X 22 CrMoV 12 1** (1.4923): This heat treatable chrome-molybdenum steel has been used very successfully for heat resistant disc springs. Springs of 1.5 to 6 mm thickness

are made from strip or plate. For thicker springs, forged rings can be used.

Figure 38 shows the mechanical properties and Young's modulus 'E' with respect to temperature. It should be noted that with a chrome content of 12% this steel is not corrosion resistant.

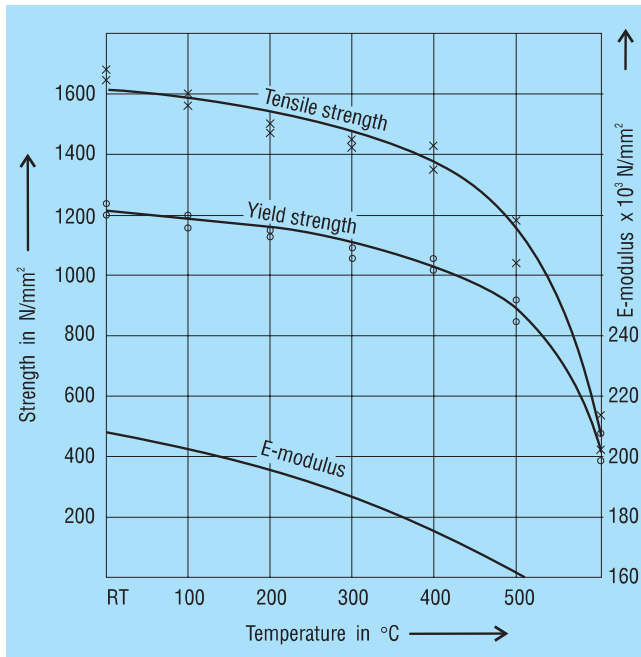

Figure 38
Yield stress and 'E' modulus of steel X 22 CrMoV 12 1 with respect to temperature.

● **X 39 CrMo 17-1** (1.4122): Here we have a chrome-molybdenum alloyed heat treatable martensitic steel which is also suitable for corrosion resistant springs. Because of the molybdenum it may be used up to 400°C. However, at these temperatures both the tensile strength and 'E' are reduced.

In order to achieve the required properties, this steel must be hardened to higher values which raises the question of stress corrosion. Unfortunately, in the light of cur-

rent technical knowledge we cannot completely discount the possibility of delayed brittle fracture.

Copper Alloys

Copper alloys are absolutely non-magnetic and have very good electric conductivity. Moreover, they are corrosion-resistant against many media. These characteristics make them suitable for many disc spring applications.

● **CuSn 8** (2.1030): Tin bronze as per DIN EN 1654 is an alloy of copper and tin, which obtains its spring properties from cold working. The tensile strength is certainly lower than spring steel and the 'E' modulus is only 55% of the value for steel. This must be considered in the spring calculation and allows their use in applications where very low spring loads are required.

● **CuBe 2** (2.1247): Beryllium copper is an outstanding spring material. This heat treatable alloy has strength values comparable with steel. However, Young's modulus 'E' is only 60% of that for steel. It has very good corrosion resistance and may be used at very low temperatures nearing absolute zero.

Nickel and Cobalt Alloys

From the large number of nickel-chrome and nickel-chrome-cobalt based alloys some have achieved importance for disc springs. By alloying with aluminium, titanium and/or niobium/tantalum they are precipitation hardenable. These materials are very tough, that is to say they have high strength and a low elastic ratio. Therefore, the probability of more set in the spring must be considered. Against this are the outstanding fatigue pro-

erties. With correct spring proportions this is good over the total spring travel. Because of the material composition they have outstanding corrosion resistance to many media. All these alloys are very expensive and often hard to work, and as a rule have long deliveries. They are therefore only used where no other material is suitable due to technical considerations.

● **NiCr 20 Co 18 Ti (Nimonic 90)** (2.4632, 2.4969): These nickel-chrome-cobalt alloy gives the least problems in processing and is therefore the most often used. It has very good heat resistance and can be used up to 700°C with suitable dimensioning.

● **NiCr 15 Fe 7 TiAl (Inconel X 750)** (2.4669) and **NiCr 19 NbMo (Inconel 718)** (2.4668): These nickel-chrome alloys are practically cobalt-free, and are therefore used in reactor applications. The hardening process is difficult and expensive. The application is limited and only used in special cases. NIMONIC and INCONEL are trade names of Inco Alloys International.

● **DURATHERM 600**: This is a heat treatable alloy of the cobalt-nickel series with outstanding mechanical properties. At a temperature of 0°C the material is non-magnetic. It can be used at very high temperatures (600°C and over). The very high price of this alloy limits its use to very special applications. DURATHERM is a trade name of Vacuum-schmelze GmbH in Hanau.

7.4 Table of Material Properties

Short Name Steel for Normal Applications	AISI ASTM	Mat.-No.	Standard	Chemical Analysis in %		
				C	Si	Mn
Spring Steel						
C 60S	1060	1.1211	DIN EN 10132-4	0.57...0.65	0.15...0.35	0.60...0.90
C 67S	1070	1.1231	DIN EN 10132-4	0.65...0.73	0.15...0.35	0.60...0.90
C 75S	1078	1.1248	DIN EN 10132-4	0.70...0.80	0.15...0.35	0.60...0.90
51 CrV 4	6150	1.8159	DIN EN 10132-4	0.47...0.55	max. 0.40	0.70...1.10
			DIN 17221	0.47...0.55	0.15...0.40	0.70...1.10
Corrosion Resistant Steel						
X 10 CrNi 18-8	301	1.4310	DIN EN 10151	0.05...0.15	max. 2.0	max. 2.0
X 7 CrNiAl 17-7	631	1.4568	DIN EN 10151	max. 0.09	max. 0.7	max. 1.0
X 5 CrNiMo 17-12-2	316	1.4401	DIN EN 10151	max. 0.07	max. 1.0	max. 2.0
X 5 CrNi 18-10	304	1.4301	DIN EN 10151	max. 0.07	max 1.0	max. 2.0
Heat Resistant Steel						
X 22 CrMoV 12-1	–	1.4923	DIN EN 10269	0.18...0.24	max. 0.5	0.40...0.90
X 39 CrMo 17-1	–	1.4122	DIN EN 10088-2	0.33...0.45	max. 1.0	max. 1.5
Copper Alloys				Sn	P	Be
CuSn 8	–	2.1030	DIN EN 1654	7.5...8.5	0.01...0.4	–
CuBe 2	–	2.1247	DIN EN 1654	–	–	1.8...2.1
Nickel and Cobalt Alloys				Ni	Cr	Co
NiCr 20 Co 18 Ti (Nimonic 90)	HEV6 5829C (AMS)	2.4632 / 2.4969		Balance	18.0...21.0	15.0...21.0
NiCr 15 Fe 7 TiAl (Inconel X 750)	688 5542L (AMS)	2.4669		70.0 min.	14.0...17.0	1.0 max.
NiCr 19 NbMo (Inconel 718)	5596J (AMS)	2.4668		50.0...55.0	17.0...21.0	1.0 max.
Duratherm 600	–	–		Balance	12	40...41
Nickel and Cobalt Alloys (contd.)				S	P	B
NiCr 20 Co 18 Ti (Nimonic 90)	HEV6 5829C (AMS)	2.4632 / 2.4969		0.015 max.	0.03 max.	0.02 max.
NiCr 15 Fe 7 TiAl (Inconel X 750)	688 5542L (AMS)	2.4669		0.015 max.	0.020 max.	–
NiCr 19 NbMo (Inconel 718)	5596J (AMS)	2.4668		0.015 max.	0.015 max.	0.006 max.
Duratherm 600	–	–		–	–	–

P max.	S max.	Cr	V	Mo	Ni		N
0.025	0.025	max. 0.40	–	max. 0.10	max. 0.40		
0.025	0.025	max. 0.40	–	max. 0.10	max. 0.40		
0.025	0.025	max. 0.40	–	max. 0.10	max. 0.40		
0.025	0.025	0.90...1.20	0.10...0.25	max. 0.10	max. 0.40		
0.030	0.030	0.90...1.20	0.10...0.20	–	–		
0.045	0.015	16.0...19.0	–	max. 0.8	6.0...9.5		–
0.040	0.015	16.0...18.0	–	–	6.5...7.8		–
0.045	0.015	16.5...18.5	–	2.0...2.5	10.0...13.0		max. 0.11
0.045	0.015	17.0...19.5	–	–	8.0...10.5		max. 0.11
0.025	0.015	11.0...12.5	0.25...0.35	0.80...1.20	0.30...0.80		
0.040	0.03	15.5...17.5	–	0.8...1.3	max. 1.0		
Ni + Co	Cu						
–	Balance						
max. 0.3	Balance						
Ti	Al	C	Si	Mn	Fe	Cu	Zr
2.0...3.0	1.0...2.0	0.13 max.	1.0 max.	1.0 max.	1.5 max.	0.2 max.	0.15 max.
2.25...2.75	0.40...1.00	0.08 max.	0.50 max.	1.0 max.	5.0...9.0	0.5 max.	–
0.70...1.15	0.3...0.7	0.02...0.08	0.35 max.	0.35 max.	Balance	0.2 max.	–
1.8...2.2	–	–	–	8.7	–	–	
Nb + Ta	Mo	W					
–	–	–					
0.7...1.2	–	–					
4.8...5.5	2.8...3.3	–					
–	4	3.9					

Short Name Steel for Normal Applications	AISI ASTM	Mat.-No. REF	Standard	Physical and Mechanical Properties					
				Density Kg/dm ³	E-modulus in kN/mm ²				
				at RT °C	100 °C	200 °C	300 °C		
Spring Steel									
C 60S	1060	1.1211	DIN EN 10132-4	7.85	206	202	–	–	
C 67S	1070	1.1231	DIN EN 10132-4	7.85	206	202	–	–	
C 75S	1078	1.1248	DIN EN 10132-4	7.85	206	202	–	–	
51 CrV 4	6150	1.8159	DIN EN 10132-4	7.85	206	202	196	–	
			DIN 17221						
Corrosion Resistant Steel									
X 10 CrNi 18-8	301	1.4310	DIN EN 10151	7.90	190	186	180	–	
X 7 CrNiAl 17-7	631	1.4568	DIN EN 10151	7.90	195	190	180	171	
X 5 CrNiMo 17-12-2	316	1.4401	DIN EN 10151	7.95	180	176	171	–	
X 5 CrNi 18-10	304	1.4301	DIN EN 10151	7.90	185	179	171	–	
Heat Resistant Steel									
X 22 CrMoV 12-1	–	1.4923	DIN EN 10269	7.7	216	209	200	190	
X 39 CrMo 17-1	–	1.4122	DIN EN 10088-2	7.7	215	212	205	200	
Copper Alloys									
CuSn 8	–	2.1030	DIN EN 1654	8.3	115	110	–	–	
CuBe 2	–	2.1247	DIN EN 1654	8.8	135	131	125	–	
Nickel and Cobalt Alloys									
NiCr 20 Co 18 Ti (Nimonic 90)	HEV6 5829C (AMS)	2.4632 / 2.4969		8.18	220	216	208	202	
NiCr 15 Fe 7 TiAl (Inconel X 750)		2.4669		8.28	214	207	198	190	
NiCr 19 NbMo (Inconel 718)	5542L (AMS)	2.4668		8.19	199	195	190	185	
Duratherm 600	–	–		8.50	220	215	208	202	

400 °C	500 °C	600 °C	Working Temperature N/mm ²	Tensile Strength mm	Thickness range	Availability
-	-	-	-20...+100	1150-1750	0.2...7.0	easy
-	-	-	-20...+100	1200-1800	0.1...2.5	easy
-	-	-	-20...+100	1200-1800	0.1...1.5	easy
-	-	-	-50...+200	1200-1800	0.3...8.0	easy
-	-	-	-200...+200	1150-1500	0.2...2.5	easy
-	-	-	-200...+300	1150-1700	0.2...4.0	less easy
-	-	-	-200...+200	1000-1500	0.2...1.6	difficult
-	-	-	-200...+200	1000-1500	0.2...1.6	less easy
179	167	-	-50...+500	1200-1400	1.5...20	easy
190	-	-	-50...+400	1200-1400	0.3...6.0	easy
-	-	-	-50...+100	590-690	0.1...6.0	easy
-	-	-	-260...+200	1270-1450	0.1...2.5	easy
193	187	178	-200...+700	≥ 1100	to 6.35	difficult
179	170	158	-200...+600	≥ 1170	to 6.35	difficult
179	174	167	-200...+600	≥ 1240	to 6.35	difficult
195	188	-	-200...+550	1150-1550	0.1...2.0	difficult

The values quoted for E-modulus and tensile strength are for reference only.
 The range of working temperature and thickness only serve as an indication.
 The heat treatment and the hardness of disc springs made from heat resistant steels is deviating from the standards mentioned above.

Special Types

Chapter 8

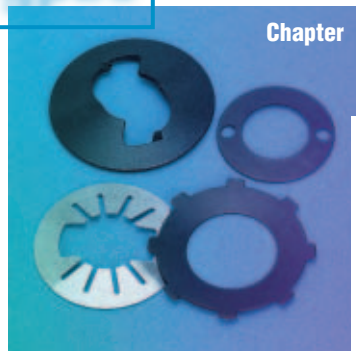

8.1 Disc Springs for Preloading Bearings	79
8.2 Slotted Disc Springs	79
8.3 Disc Springs with Trapezoidal Cross-Section	80

8.1 Disc Springs for Preloading Bearings

With every ball bearing there is radial play so it may function correctly. This radial play or clearance can cause considerable noise at high speeds. In many cases it is possible to achieve a quiet running bearing assembly by the use of a suitable disc spring to apply an axial load to the bearing. Similarly, the springs can be used to accommodate the build up of tolerances or thermal movements within the assembly. SCHNORR has, in close cooperation with SKF in Schweinfurt, designed a special range of disc springs for this purpose – our “K” springs for ball bearings. In addition to the normal range “slotted” springs are available up to a diameter of 95 mm. This special design generates very small loads and will accommodate large deflections

(section 9.5). We will be pleased to send our special “K” Spring leaflet on request. Because of the different dimensions of these springs compared with “normal” disc springs, the load and dimensional tolerances of DIN 2093 (chapter 5) do not apply.

For the dimensions of “K” Disc Springs please see section 9.5.

8.2 Slotted Disc Springs

The inclusion of slots on either the inner or outer diameter creates a lever which works on the unslotted portion of the spring. This has the effect of reducing the spring load and increasing the deflection (figure 39). The resulting spring has a softer characteristic with a large deflection and in proportion to the outside diameter smaller spring loads. It

is most important with this type of spring that the permissible stresses in the annular portion are not exceeded and, if necessary, the outside diameter must be increased to compensate.

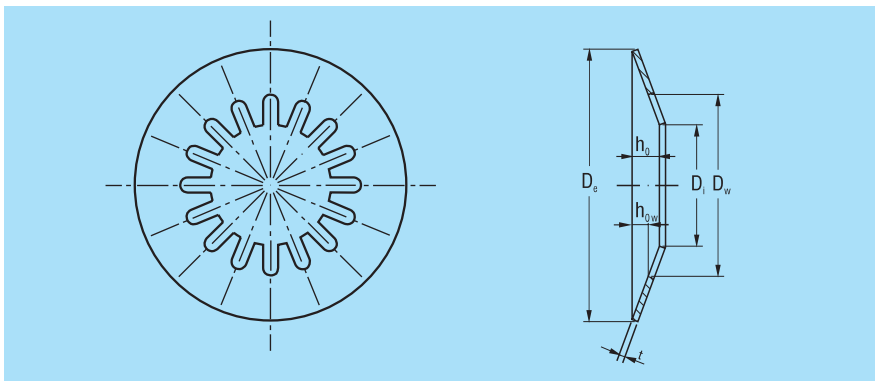

Figure 39
Slotted Disc Spring

Taking these limitations and a few design features into account, this type of spring has many possible applications. The classic example is the automotive clutch spring. Notable are the slotted ball bearing preload springs which give extremely low loads (see section 8.1 and the dimension tables section 9.3).

The first approximation for the calculation of slotted disc springs can be achieved by considering the lever arm and the formula in section 1.2.

The loads generated depend to a large extent on the shape of the slots or the corresponding fingers. The deflection of the fingers is only a small percentage of the total deflection and can be ignored. An exact calculation is given in [7]. If you need to consider the use of slotted Disc Springs we recommend you contact our Technical department so the design and manufacture may be discussed.

8.3 Disc Springs with Trapezoidal Cross-Section

By the use of a trapezoidal cross-section it is possible to equalise the stresses on the spring upper and lower surfaces. The advantageous tensile stresses on the lower surface contribute to a better fatigue life. The equal compressive stresses on the upper surface result in more set. A similar distribution of the tensile stresses at points II and III to give the optimum fatigue life can also be achieved with a rectangular cross-section spring if the ratios δ and h_0/t are correctly chosen [5][6]. In this regard therefore, the trapezoidal cross-section offers no advantages. Compared with a standard spring having a similar angle on the top surface, a trapezoidal spring will give less deflection. This can be increased by including intermediate rings, but these will

also increase the overall stack length and require more space.

The main advantage of the trapezoidal cross-section disc spring is the ability to limit the stroke without additional parts. It is therefore possible to design a spring which is relatively fatigue free over the complete deflection range with relatively little increase in load towards the end of the stroke.

With the same installation space and under consideration of the permissible stresses, no more favourable spring data (more force or more deflection) can be achieved with disc springs with a trapezoidal cross-section than with springs with a square cross-section.

These few advantages and the higher manufacturing costs are the reasons why the trapezoidal disc spring is of no practical importance today.

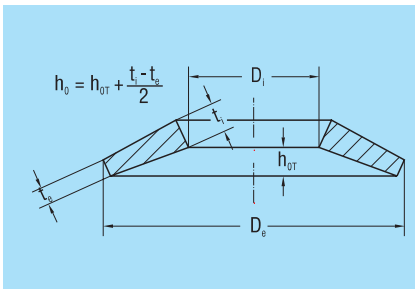

Figure 40
Disc Spring with
trapezoidal cross section



Dimensional Tables

9.1 Explanation of the Tables	83
Article Reference	83
Load and stress specifications	83
9.2 Dimension Tables for SCHNORR Disc Springs	84
9.3 Dimension Tables for Corrosion Resistant SCHNORR Disc Springs	98
9.4 Dimension Tables for Heat Resistant SCHNORR Disc Springs	108
9.5 Dimension Tables for SCHNORR “K” Disc Springs	128
9.6 Dimension Tables for SCHNORR “Z” Disc Springs	134

9.1 Explanation of the Tables

The following tables list the springs to DIN 2093 as well as those to Schnorr Works Standards. Those to DIN 2093 are shown in heavy type. The prefix A, B and C show the corresponding series. All sizes are normally kept in stock and the heavy type does not indicate a better delivery.

The article number quoted is for normal manufacture from spring steel with phosphate finish.

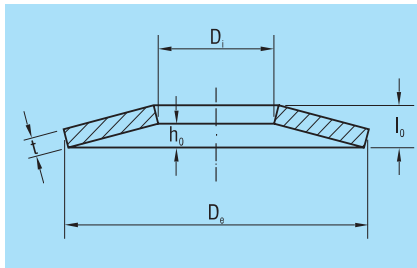

Figure 41
Cross section with main dimensions

Article Reference

Reference for a Disc Spring with $D_o = 40$ mm,
 $D_i = 20.4$ mm and $t = 1.5$ mm:

Disc Spring 40 x 20.4 x 1.5

or for a spring to DIN 2093:

Disc Spring DIN 2093-B 40

or with the article number:

Disc Spring 012800

Load and stress specifications

The load and the corresponding stresses are given for the four points $s = 0.25 h_o$, $s = 0.5 h_o$, $s = 0.75 h_o$ and $s = h_o$. This allows the relevant graphs for load and stress to be accurately drawn.

At $s = 0.75 h_o$, DIN 2093 quotes rounded values for the deflection s . Spring load F and the corresponding stress s are calculated exactly for the rounded values. The quoted stress at $s = 0.75 h_o$ is the tensile stress on

the underside at point II or III whichever is the greater.

Static or infrequently loaded springs may be compressed to the flat condition (see section 2.1). It should be noted that from $s = 0.75 h_o$ the actual characteristic progressively increases from that calculated (see sections 1.7 and figure 10).

For dynamic application the calculation in section 2.2 must be completed. With the help of the drawn graph for stress and the fatigue life diagrams (figures 18 – 20) the expected dynamic life may be obtained without calculation.

All values are based on a Young's modulus 'E' of 206000 N/mm² with $\mu = 0.3$ and are therefore only valid for Disc Springs from spring steel to DIN EN 10132-4 and DIN 17221 (e.g. 51 CrV 4 or C 67S). The use of other materials necessitates recalculation with the correct value for Young's modulus 'E'. For lower tensile strength the free height h_o and the overall height l_o must be amended (see chapters 1 and 2).

When considering the use of special sizes or springs from special materials we recommend you leave the work to us. We will be pleased to go through the necessary calculations quickly, at no cost and advise you of the possibilities of manufacture.

9.2 Dimension Tables for SCHNORR Disc Springs

Article No.	Ordering Dimensions						Weight/ 1000 pcs. [kg]	Stress σ_{OM} at $s = h_0$ [N/mm ²]
	D_o [mm]	D_i [mm]	t [mm]	l_0 [mm]	h_0 [mm]	h_0/t		
000100	6	3.2	0.3	0.45	0.15	0.50	0.044	-1623
000200	8	3.2	0.2	0.4	0.20	1.00	0.064	-710
000300	8	3.2	0.3	0.55	0.25	0.83	0.093	-1332
000400	8	3.2	0.4	0.6	0.20	0.50	0.126	-1421
000550 C	8	4.2	0.2	0.45	0.25	1.25	0.055	-1003
000600 B	8	4.2	0.3	0.55	0.25	0.83	0.080	-1505
000700 A	8	4.2	0.4	0.6	0.20	0.50	0.107	-1605
000800	10	3.2	0.3	0.65	0.35	1.17	0.157	-1147
000900	10	3.2	0.4	0.7	0.30	0.75	0.211	-1311
001000	10	3.2	0.5	0.75	0.25	0.50	0.266	-1365
001100	10	4.2	0.4	0.7	0.30	0.75	0.193	-1384
001200	10	4.2	0.5	0.75	0.25	0.50	0.243	-1441
001300 C	10	5.2	0.25	0.55	0.30	1.20	0.109	-957
001400 B	10	5.2	0.4	0.7	0.30	0.75	0.170	-1531
001500 A	10	5.2	0.5	0.75	0.25	0.50	0.214	-1595
001600	12	4.2	0.4	0.8	0.40	1.00	0.297	-1228
001700	12	4.2	0.5	0.85	0.35	0.70	0.374	-1343
001800	12	4.2	0.6	1	0.40	0.67	0.450	-1841
001900	12	5.2	0.5	0.9	0.40	0.80	0.345	-1619
002000	12	5.2	0.6	0.95	0.35	0.58	0.415	-1700
002100	12	6.2	0.5	0.85	0.35	0.70	0.310	-1544
002200	12	6.2	0.6	0.95	0.35	0.58	0.373	-1853
002300	12.5	5.2	0.5	0.85	0.35	0.70	0.382	-1288
002050 C	12.5	6.2	0.35	0.8	0.45	1.29	0.251	-1250
002500 B	12.5	6.2	0.5	0.85	0.35	0.70	0.346	-1388
002700 A	12.5	6.2	0.7	1	0.30	0.43	0.488	-1666
002750 C	14	7.2	0.35	0.8	0.45	1.29	0.308	-1018
002800 B	14	7.2	0.5	0.9	0.40	0.80	0.425	-1293
002900 A	14	7.2	0.8	1.1	0.30	0.38	0.676	-1551
003000	15	5.2	0.4	0.95	0.55	1.38	0.468	-1079
003100	15	5.2	0.5	1	0.50	1.00	0.588	-1226
003200	15	5.2	0.6	1.05	0.45	0.75	0.708	-1324
003300	15	5.2	0.7	1.1	0.40	0.57	0.828	-1373
003500	15	6.2	0.5	1	0.50	1.00	0.553	-1275
003600	15	6.2	0.6	1.05	0.45	0.75	0.665	-1377

∅ 6 – 15 mm

Deflection s, Load F and Stress σ

at s = 0.25 h ₀			s = 0.50 h ₀			s ≈ 0.75 h ₀			s = 1.00 h ₀		
s	F	σ	s	F	σ	s	F	σ	s	F	σ
[mm]	[N]	[N/mm ²]	[mm]	[N]	[N/mm ²]	[mm]	[N]	[N/mm ²]	[mm]	[N]	[N/mm ²]
0.038	45	343	0.075	84	750	0.110	117	1187	0.150	153	1753
0.050	12	233	0.100	20	433	0.150	26	600	0.200	30	733
0.063	46	401	0.125	79	750	0.190	105	1057	0.250	126	1290
0.050	69	365	0.100	130	792	0.150	186	1281	0.200	238	1832
0.063	21	409	0.125	33	753	0.190	39	1044	0.250	42	1251
0.063	52	501	0.125	89	938	0.190	119	1325	0.250	142	1621
0.050	78	343	0.100	147	749	0.150	210	1218	0.200	269	1750
0.088	51	378	0.175	82	697	0.260	98	951	0.350	108	1158
0.075	75	285	0.150	133	663	0.230	182	1168	0.300	220	1698
0.063	104	410	0.125	195	884	0.190	282	1447	0.250	357	2028
0.075	79	405	0.150	140	760	0.230	192	1084	0.300	232	1322
0.063	110	359	0.125	206	778	0.190	297	1280	0.250	377	1803
0.075	30	380	0.150	48	702	0.230	58	980	0.300	63	1169
0.075	88	485	0.150	155	912	0.230	213	1303	0.300	257	1591
0.063	122	343	0.125	228	749	0.190	329	1238	0.250	418	1749
0.100	85	385	0.200	141	714	0.300	178	988	0.400	206	1205
0.088	116	293	0.175	208	671	0.260	282	1122	0.350	352	1687
0.100	224	421	0.200	405	954	0.300	557	1600	0.400	694	2358
0.100	150	493	0.200	263	923	0.300	350	1291	0.400	424	1596
0.088	196	372	0.175	361	828	0.260	502	1350	0.350	641	1990
0.088	134	475	0.175	239	894	0.260	324	1249	0.350	404	1569
0.088	214	531	0.175	394	1007	0.260	547	1417	0.350	699	1795
0.088	111	245	0.175	200	568	0.260	270	955	0.350	337	1444
0.113	84	506	0.225	130	932	0.340	152	1284	0.450	160	1542
0.088	120	420	0.175	215	791	0.260	291	1105	0.350	363	1388
0.075	239	403	0.150	457	864	0.230	673	1419	0.300	855	1957
0.113	68	418	0.225	106	770	0.340	123	1061	0.450	131	1274
0.100	120	419	0.200	210	787	0.300	279	1101	0.400	338	1363
0.075	284	390	0.150	547	826	0.230	813	1341	0.300	1040	1836
0.138	101	401	0.275	154	735	0.410	175	998	0.550	181	1202
0.125	133	383	0.250	221	711	0.380	280	992	0.500	321	1199
0.113	171	269	0.225	302	630	0.340	409	1093	0.450	499	1625
0.100	214	358	0.200	395	789	0.300	555	1291	0.400	704	1865
0.125	138	424	0.250	229	787	0.380	291	1100	0.500	334	1331
0.113	178	400	0.225	314	752	0.340	426	1060	0.450	519	1307

∅ 15 – 22.5 mm

Article No.	Ordering Dimensions						Weight/ 1000 pcs. [kg]	Stress σ_{OM} at $s = h_0$ [N/mm ²]
	D_e [mm]	D_i [mm]	t [mm]	l_0 [mm]	h_0 [mm]	h_0/t		
003700	15	6.2	0.7	1.1	0.40	0.57	0.778	-1428
003800	15	8.2	0.7	1.1	0.40	0.57	0.654	-1646
003900	15	8.2	0.8	1.2	0.40	0.50	0.740	-1881
004100 C	16	8.2	0.4	0.9	0.50	1.25	0.444	-988
004300 B	16	8.2	0.6	1.05	0.45	0.75	0.672	-1333
004400	16	8.2	0.7	1.15	0.45	0.64	0.786	-1555
004500	16	8.2	0.8	1.2	0.40	0.50	0.888	-1580
004600 A	16	8.2	0.9	1.25	0.35	0.39	1.002	-1555
004700	18	6.2	0.4	1	0.60	1.50	0.677	-816
004800	18	6.2	0.5	1.1	0.60	1.20	0.850	-1021
004900	18	6.2	0.6	1.2	0.60	1.00	1.024	-1225
005000	18	6.2	0.7	1.25	0.55	0.79	1.197	-1310
005100	18	6.2	0.8	1.3	0.50	0.63	1.353	-1361
005200	18	8.2	0.5	1.1	0.60	1.20	0.762	-1101
005300	18	8.2	0.7	1.25	0.55	0.79	1.073	-1412
005400	18	8.2	0.8	1.3	0.50	0.63	1.213	-1468
005500	18	8.2	1	1.4	0.40	0.40	1.524	-1468
005550 C	18	9.2	0.45	1.05	0.60	1.33	0.651	-1052
005600 B	18	9.2	0.7	1.2	0.50	0.71	0.999	-1363
005700 A	18	9.2	1	1.4	0.40	0.40	1.418	-1558
005800	20	8.2	0.6	1.3	0.70	1.17	1.191	-1202
005900	20	8.2	0.7	1.35	0.65	0.93	1.393	-1302
006000	20	8.2	0.8	1.4	0.60	0.75	1.574	-1373
006100	20	8.2	0.9	1.45	0.55	0.61	1.776	-1416
006200	20	8.2	1	1.55	0.55	0.55	1.978	-1574
006300 C	20	10.2	0.5	1.15	0.65	1.30	0.876	-1024
006400 B	20	10.2	0.8	1.35	0.55	0.69	1.394	-1386
006500	20	10.2	0.9	1.45	0.55	0.61	1.573	-1560
006600	20	10.2	1	1.55	0.55	0.55	1.752	-1733
006700 A	20	10.2	1.1	1.55	0.45	0.41	1.913	-1560
006800	20	10.2	1.25	1.75	0.50	0.40	2.181	-1969
006900	20	10.2	1.5	1.8	0.30	0.20	2.610	-1418
007000 C	22.5	11.2	0.6	1.4	0.80	1.33	1.361	-1178
007100 B	22.5	11.2	0.8	1.45	0.65	0.81	1.799	-1276
007200 A	22.5	11.2	1.25	1.75	0.50	0.40	2.814	-1534

Deflection s, Load F and Stress σ

at $s = 0.25 h_0$			$s = 0.50 h_0$			$s \approx 0.75 h_0$			$s = 1.00 h_0$		
s	F	σ	s	F	σ	s	F	σ	s	F _c	σ
[mm]	[N]	[N/mm ²]	[mm]	[N]	[N/mm ²]	[mm]	[N]	[N/mm ²]	[mm]	[N]	[N/mm ²]
0.100	222	328	0.200	411	727	0.300	578	1195	0.400	733	1734
0.100	256	479	0.200	474	909	0.300	666	1291	0.400	844	1624
0.100	367	523	0.200	689	997	0.300	982	1423	0.400	1261	1800
0.125	84	399	0.250	131	735	0.380	155	1018	0.500	165	1220
0.113	172	420	0.225	304	790	0.340	412	1115	0.450	503	1377
0.113	254	461	0.225	461	871	0.340	641	1238	0.450	798	1539
0.100	308	343	0.200	579	749	0.300	825	1218	0.400	1059	1749
0.088	363	386	0.175	697	820	0.260	1004	1287	0.350	1319	1831
0.150	85	319	0.300	126	583	0.450	139	791	0.600	137	944
0.150	130	350	0.300	206	646	0.450	245	885	0.600	267	1070
0.150	191	382	0.300	317	708	0.450	400	980	0.600	462	1195
0.138	236	253	0.275	414	600	0.410	550	1034	0.550	672	1580
0.125	286	333	0.250	523	745	0.380	733	1256	0.500	912	1803
0.150	140	417	0.300	222	769	0.450	265	1056	0.600	288	1279
0.138	255	434	0.275	446	815	0.410	594	1135	0.550	725	1412
0.125	309	292	0.250	564	660	0.380	791	1124	0.500	984	1624
0.100	425	388	0.200	814	824	0.300	1181	1309	0.400	1537	1842
0.150	121	440	0.300	186	809	0.450	214	1106	0.600	223	1333
0.125	233	421	0.250	417	792	0.380	572	1126	0.500	699	1387
0.100	451	382	0.200	865	814	0.300	1254	1295	0.400	1631	1826
0.175	214	432	0.350	342	797	0.530	413	1103	0.700	453	1327
0.163	262	416	0.325	442	775	0.490	570	1080	0.650	668	1320
0.150	315	398	0.300	557	748	0.450	751	1048	0.600	921	1300
0.138	374	311	0.275	685	696	0.410	949	1147	0.550	1201	1690
0.138	494	374	0.275	917	823	0.410	1288	1336	0.550	1648	1944
0.163	141	422	0.325	219	776	0.490	254	1067	0.650	268	1283
0.138	304	421	0.275	547	793	0.410	745	1112	0.550	929	1394
0.138	412	452	0.275	754	856	0.410	1045	1206	0.550	1323	1520
0.138	544	484	0.275	1010	920	0.410	1418	1300	0.550	1815	1646
0.113	548	379	0.225	1050	809	0.340	1531	1301	0.450	1976	1821
0.125	890	484	0.250	1708	1030	0.380	2507	1665	0.500	3222	2310
0.075	857	427	0.150	1695	877	0.230	2576	1381	0.300	3340	1843
0.200	240	488	0.400	370	897	0.600	425	1227	0.800	444	1478
0.163	306	412	0.325	533	771	0.490	710	1083	0.650	855	1335
0.125	693	383	0.250	1330	815	0.380	1952	1316	0.500	2509	1825

∅ 23 – 31.5 mm

Article No.	Ordering Dimensions						Weight/ 1000 pcs. [kg]	Stress σ_{OM} at $s = h_0$ [N/mm ²]
	D_o [mm]	D_i [mm]	t [mm]	l_0 [mm]	h_0 [mm]	h_0/t		
007400	23	8.2	0.7	1.5	0.80	1.14	1.939	-1173
007500	23	8.2	0.8	1.55	0.75	0.94	2.192	-1257
007600	23	8.2	0.9	1.6	0.70	0.78	2.472	-1320
007700	23	8.2	1	1.7	0.70	0.70	2.753	-1466
007800	23	10.2	0.9	1.65	0.75	0.83	2.270	-1500
007900	23	10.2	1	1.7	0.70	0.70	2.527	-1556
008000	23	10.2	1.25	1.9	0.65	0.52	3.172	-1806
008100	23	12.2	1	1.6	0.60	0.60	2.255	-1467
008200	23	12.2	1.25	1.85	0.60	0.48	2.807	-1834
008350	23	12.2	1.5	2	0.50	0.33	3.359	-1834
008600	25	10.2	1	1.75	0.75	0.75	3.105	-1371
008700 C	25	12.2	0.7	1.6	0.90	1.29	1.994	-1238
008800 B	25	12.2	0.9	1.6	0.70	0.78	2.543	-1238
008900	25	12.2	1	1.8	0.80	0.80	2.832	-1573
009000	25	12.2	1.25	1.95	0.70	0.56	3.526	-1720
009100 A	25	12.2	1.5	2.05	0.55	0.37	4.219	-1622
009200	28	10.2	0.8	1.75	0.95	1.19	3.233	-1078
009300	28	10.2	1	1.9	0.90	0.90	4.062	-1277
009400	28	10.2	1.25	2.05	0.80	0.64	5.057	-1419
009500	28	10.2	1.5	2.2	0.70	0.47	6.051	-1490
009600	28	12.2	1	1.95	0.95	0.95	3.789	-1415
009700	28	12.2	1.25	2.1	0.85	0.68	4.717	-1583
009800	28	12.2	1.5	2.25	0.75	0.50	5.645	-1676
009900 C	28	14.2	0.8	1.8	1.00	1.25	2.760	-1282
010000 B	28	14.2	1	1.8	0.80	0.80	3.468	-1282
010100	28	14.2	1.25	2.1	0.85	0.68	4.317	-1702
010200 A	28	14.2	1.5	2.15	0.65	0.43	5.166	-1562
010300	31.5	12.2	1	2.1	1.10	1.10	5.035	-1250
010400	31.5	12.2	1.25	2.2	0.95	0.76	6.268	-1349
010500	31.5	12.2	1.5	2.35	0.85	0.57	7.501	-1448
010650 C	31.5	16.3	0.8	1.85	1.05	1.31	3.442	-1077
010700 B	31.5	16.3	1.25	2.15	0.90	0.72	5.384	-1442
010800	31.5	16.3	1.5	2.4	0.90	0.60	6.443	-1730
010900 A	31.5	16.3	1.75	2.45	0.70	0.40	7.546	-1570
011000	31.5	16.3	2	2.75	0.75	0.38	8.605	-1923

Deflection s, Load F and Stress σ

at $s = 0.25 h_0$			$s = 0.50 h_0$			$s \approx 0.75 h_0$			$s = 1.00 h_0$		
s	F	σ	s	F	σ	s	F	σ	s	F	σ
[mm]	[N]	[N/mm ²]	[mm]	[N]	[N/mm ²]	[mm]	[N]	[N/mm ²]	[mm]	[N]	[N/mm ²]
0.200	279	397	0.400	448	733	0.600	544	1007	0.800	602	1221
0.188	332	384	0.375	560	714	0.560	717	988	0.750	842	1214
0.175	391	251	0.350	687	595	0.530	925	1046	0.700	1119	1563
0.175	507	315	0.350	909	723	0.530	1249	1241	0.700	1536	1820
0.188	463	469	0.375	802	877	0.560	1055	1221	0.750	1273	1512
0.175	538	451	0.350	964	849	0.530	1325	1204	0.700	1629	1487
0.163	870	422	0.325	1627	923	0.490	2320	1511	0.650	2955	2159
0.150	475	429	0.300	872	813	0.450	1217	1152	0.600	1536	1446
0.150	863	399	0.300	1630	868	0.450	2331	1404	0.600	3000	2010
0.125	1159	473	0.250	2250	994	0.380	3338	1586	0.500	4320	2178
0.188	492	397	0.375	870	745	0.560	1168	1041	0.750	1436	1295
0.225	331	499	0.450	515	919	0.680	601	1265	0.900	635	1519
0.175	367	389	0.350	644	730	0.530	868	1031	0.700	1050	1268
0.200	585	500	0.400	1021	938	0.600	1359	1312	0.800	1647	1624
0.175	848	357	0.350	1573	792	0.530	2232	1320	0.700	2814	1895
0.138	1040	425	0.275	2007	898	0.410	2910	1410	0.550	3821	1988
0.238	348	375	0.475	553	692	0.710	661	947	0.950	723	1149
0.225	512	385	0.450	872	718	0.680	1135	1004	0.900	1337	1226
0.200	737	327	0.400	1339	735	0.600	1853	1225	0.800	2322	1797
0.175	1003	424	0.350	1899	911	0.530	2745	1478	0.700	3511	2074
0.238	590	467	0.475	992	870	0.710	1266	1204	0.950	1482	1480
0.213	844	451	0.425	1519	849	0.640	2089	1200	0.850	2590	1491
0.188	1149	406	0.375	2159	883	0.560	3065	1423	0.750	3949	2049
0.250	435	515	0.500	681	950	0.750	801	1304	1.000	859	1577
0.200	476	414	0.400	832	776	0.600	1107	1086	0.800	1342	1344
0.213	907	513	0.425	1634	968	0.640	2246	1369	0.850	2785	1703
0.163	1033	371	0.325	1970	795	0.490	2854	1281	0.650	3680	1806
0.275	587	426	0.550	951	788	0.830	1170	1091	1.100	1309	1320
0.238	761	385	0.475	1343	723	0.710	1800	1009	0.950	2207	1254
0.213	1033	351	0.425	1912	774	0.640	2697	1276	0.850	3413	1838
0.263	384	448	0.525	594	825	0.790	687	1132	1.050	722	1363
0.225	791	449	0.450	1409	844	0.680	1923	1194	0.900	2359	1478
0.225	1260	501	0.450	2314	950	0.680	3249	1354	0.900	4077	1689
0.175	1391	382	0.350	2669	814	0.530	3905	1310	0.700	5036	1826
0.188	2199	481	0.375	4239	1020	0.560	6148	1607	0.750	8054	2267

∅ 34 – 50 mm

Article No.	Ordering Dimensions						Weight/ 1000 pcs. [kg]	Stress σ_{OM} at $s = h_0$ [N/mm ²]
	D_o [mm]	D_i [mm]	t [mm]	l_0 [mm]	h_0 [mm]	h_0/t		
011100	34	12.3	1	2.25	1.25	1.25	6.006	-1201
011200	34	12.3	1.25	2.35	1.10	0.88	7.477	-1322
011300	34	12.3	1.5	2.5	1.00	0.67	8.948	-1442
011400	34	14.3	1.25	2.4	1.15	0.92	7.074	-1435
011500	34	14.3	1.5	2.55	1.05	0.70	8.465	-1572
011600	34	16.3	1.5	2.55	1.05	0.70	7.911	-1658
011700	34	16.3	2	2.85	0.85	0.43	10.57	-1790
011850 C	35.5	18.3	0.9	2.05	1.15	1.28	4.952	-1042
011900 B	35.5	18.3	1.25	2.25	1.00	0.80	6.865	-1258
012000 A	35.5	18.3	2	2.8	0.80	0.40	10.97	-1611
012100	40	14.3	1.25	2.65	1.40	1.12	10.40	-1213
012200	40	14.3	1.5	2.75	1.25	0.83	12.45	-1299
012300	40	14.3	2	3.05	1.05	0.53	16.63	-1455
012400	40	16.3	1.5	2.8	1.30	0.87	11.89	-1392
012500	40	16.3	2	3.1	1.10	0.55	15.89	-1571
012600	40	18.3	2	3.15	1.15	0.58	15.04	-1712
012700 C	40	20.4	1	2.3	1.30	1.30	7.067	-1024
012800 B	40	20.4	1.5	2.65	1.15	0.77	10.53	-1359
012900	40	20.4	2	3.1	1.10	0.55	14.06	-1733
013000 A	40	20.4	2.25	3.15	0.90	0.40	15.72	-1595
013100	40	20.4	2.5	3.45	0.95	0.38	17.52	-1871
013250 C	45	22.4	1.25	2.85	1.60	1.28	11.34	-1227
013300 B	45	22.4	1.75	3.05	1.30	0.74	15.89	-1396
013400 A	45	22.4	2.5	3.5	1.00	0.40	22.77	-1534
013500	50	18.4	1.25	2.85	1.60	1.28	16.13	-892
013600	50	18.4	1.5	3.3	1.80	1.20	19.31	-1204
013700	50	18.4	2	3.5	1.50	0.75	25.79	-1338
013800	50	18.4	2.5	4.1	1.60	0.64	32.14	-1784
013900	50	18.4	3	4.4	1.40	0.47	38.35	-1873
014000	50	20.4	2	3.5	1.50	0.75	24.85	-1371
014100	50	20.4	2.5	3.85	1.35	0.54	30.97	-1543
014200	50	22.4	2	3.6	1.60	0.80	23.82	-1511
014300	50	22.4	2.5	3.9	1.40	0.56	29.68	-1653
014400 C	50	25.4	1.25	2.85	1.60	1.28	13.82	-1006
014500	50	25.4	1.5	3.1	1.60	1.07	16.54	-1207

Deflection s, Load F and Stress σ

at $s = 0.25 h_0$			$s = 0.50 h_0$			$s \approx 0.75 h_0$			$s = 1.00 h_0$		
s	F	σ	s	F	σ	s	F	σ	s	F	σ
[mm]	[N]	[N/mm ²]	[mm]	[N]	[N/mm ²]	[mm]	[N]	[N/mm ²]	[mm]	[N]	[N/mm ²]
0.313	637	429	0.625	998	789	0.940	1175	1083	1.250	1258	1304
0.275	815	394	0.550	1395	734	0.830	1825	1026	1.100	2162	1255
0.250	1097	321	0.500	1982	730	0.750	2725	1225	1.000	3397	1807
0.288	913	461	0.575	1546	858	0.860	1990	1190	1.150	2347	1464
0.263	1224	447	0.525	2192	841	0.790	2997	1186	1.050	3704	1472
0.263	1291	495	0.525	2313	933	0.790	3163	1316	1.050	3908	1635
0.213	2097	445	0.425	4003	952	0.640	5803	1527	0.850	7498	2150
0.288	458	427	0.575	712	786	0.860	831	1076	1.150	884	1302
0.250	731	409	0.500	1277	766	0.750	1699	1073	1.000	2059	1329
0.200	1864	393	0.400	3576	837	0.600	5187	1332	0.800	6747	1878
0.350	904	406	0.700	1459	750	1.050	1780	1033	1.400	1984	1253
0.313	1114	376	0.625	1929	702	0.940	2550	981	1.250	3061	1207
0.263	1800	393	0.525	3363	855	0.790	4781	1392	1.050	6096	1988
0.325	1224	430	0.650	2102	802	0.980	2758	1122	1.300	3281	1376
0.275	1972	375	0.550	3663	825	0.830	5195	1359	1.100	6580	1948
0.288	2182	365	0.575	4030	810	0.860	5642	1333	1.150	7171	1946
0.325	565	422	0.650	876	776	0.980	1018	1067	1.300	1072	1283
0.288	1109	431	0.575	1953	810	0.860	2616	1134	1.150	3201	1410
0.275	2175	484	0.550	4041	920	0.830	5730	1314	1.100	7258	1646
0.225	2336	392	0.450	4481	835	0.680	6544	1339	0.900	8456	1871
0.238	3351	470	0.475	6453	997	0.710	9359	1573	0.950	12243	2219
0.400	1041	497	0.800	1620	914	1.200	1891	1253	1.600	2007	1514
0.325	1524	433	0.650	2701	814	0.980	3659	1148	1.300	4475	1421
0.250	2773	383	0.500	5320	815	0.750	7716	1296	1.000	10037	1825
0.400	757	325	0.800	1178	597	1.200	1375	817	1.600	1459	984
0.450	1379	423	0.900	2184	779	1.350	2606	1069	1.800	2837	1293
0.375	1918	259	0.750	3392	609	1.130	4586	1054	1.500	5603	1577
0.400	3703	407	0.800	6733	917	1.200	9315	1529	1.600	11673	2244
0.350	5043	530	0.700	9546	1138	1.050	13688	1824	1.400	17650	2590
0.375	1966	397	0.750	3478	745	1.130	4702	1048	1.500	5745	1295
0.338	3008	373	0.675	5601	817	1.010	7902	1330	1.350	10098	1922
0.400	2247	466	0.800	3924	872	1.200	5222	1220	1.600	6329	1509
0.350	3261	364	0.700	6044	806	1.050	8510	1324	1.400	10817	1920
0.400	854	410	0.800	1328	755	1.200	1550	1035	1.600	1646	1251
0.400	1242	447	0.800	2028	828	1.200	2512	1145	1.600	2844	1397

∅ 50 – 80 mm

Article No.	Ordering Dimensions						Weight/ 1000 pcs. [kg]	Stress σ_{OM} at $s = h_0$ [N/mm ²]
	D_o [mm]	D_i [mm]	t [mm]	l_0 [mm]	h_0 [mm]	h_0/t		
014600 B	50	25.4	2	3.4	1.40	0.70	22.09	-1408
014700	50	25.4	2.5	3.9	1.40	0.56	27.52	-1760
014800 A	50	25.4	3	4.1	1.10	0.37	32.85	-1659
014950 C	56	28.5	1.5	3.45	1.95	1.30	20.85	-1174
015000 B	56	28.5	2	3.6	1.60	0.80	27.81	-1284
015100 A	56	28.5	3	4.3	1.30	0.43	41.57	-1565
015200	60	20.5	2	4.1	2.10	1.05	38.16	-1284
015300	60	20.5	2.5	4.3	1.80	0.72	47.69	-1376
015400	60	20.5	3	4.7	1.70	0.57	57.04	-1560
015500	60	25.5	2.5	4.4	1.90	0.76	44.20	-1527
015600	60	25.5	3	4.65	1.65	0.55	52.86	-1592
015700	60	30.5	2.5	4.3	1.80	0.72	39.94	-1572
015800	60	30.5	3	4.7	1.70	0.57	47.77	-1782
015900	60	30.5	3.5	5	1.50	0.43	55.10	-1834
016050 C	63	31	1.8	4.15	2.35	1.31	32.53	-1315
016100 B	63	31	2.5	4.25	1.75	0.70	44.85	-1360
016200	63	31	3	4.8	1.80	0.60	53.86	-1679
016300 A	63	31	3.5	4.9	1.40	0.40	62.13	-1524
016400	70	25.5	2	4.5	2.50	1.25	50.78	-1135
016500	70	30.5	2.5	4.9	2.40	0.96	59.53	-1430
016600	70	30.5	3	5.1	2.10	0.70	71.19	-1502
016700	70	35.5	3	5.1	2.10	0.70	65.21	-1615
016800	70	35.5	4	5.8	1.80	0.45	86.13	-1845
016900	70	40.5	4	5.6	1.60	0.40	77.04	-1813
017000	70	40.5	5	6.2	1.20	0.24	95.15	-1700
017100 C	71	36	2	4.6	2.60	1.30	44.66	-1295
017200 B	71	36	2.5	4.5	2.00	0.80	56.11	-1246
017300 A	71	36	4	5.6	1.60	0.40	88.63	-1594
017400	80	31	2.5	5.3	2.80	1.12	82.01	-1233
017500	80	31	3	5.5	2.50	0.83	98.01	-1321
017600	80	31	4	6.1	2.10	0.53	130.0	-1480
017700	80	36	3	5.7	2.70	0.90	91.92	-1497
017800	80	36	4	6.2	2.20	0.55	121.9	-1626
017850 C	80	41	2.25	5.2	2.95	1.31	63.54	-1311
017900 B	80	41	3	5.3	2.30	0.77	84.92	-1363

Deflection s, Load F and Stress σ

at $s = 0.25 h_0$			$s = 0.50 h_0$			$s \approx 0.75 h_0$			$s = 1.00 h_0$		
s	F	σ	s	F	σ	s	F	σ	s	F	σ
[mm]	[N]	[N/mm ²]	[mm]	[N]	[N/mm ²]	[mm]	[N]	[N/mm ²]	[mm]	[N]	[N/mm ²]
0.350	1949	430	0.700	3491	810	1.050	4762	1140	1.400	5898	1421
0.350	3473	494	0.700	6437	938	1.050	9063	1332	1.400	11519	1677
0.275	4255	424	0.550	8214	897	0.830	12044	1418	1.100	15640	1987
0.488	1458	483	0.975	2259	889	1.460	2621	1217	1.950	2766	1470
0.400	1910	415	0.800	3335	778	1.200	4438	1090	1.600	5379	1349
0.325	4142	371	0.650	7895	795	0.980	11441	1281	1.300	14752	1806
0.525	2318	409	1.050	3802	758	1.580	4737	1049	2.100	5380	1273
0.450	3018	297	0.900	5379	685	1.350	7302	1165	1.800	9006	1736
0.425	4449	414	0.850	8234	909	1.280	11615	1486	1.700	14698	2145
0.475	3447	451	0.950	6081	847	1.430	8195	1190	1.900	9997	1471
0.413	4495	369	0.825	8352	812	1.240	11803	1334	1.650	15002	1922
0.450	3447	486	0.900	6145	914	1.350	8342	1285	1.800	10289	1600
0.425	5083	502	0.850	9407	953	1.280	13269	1358	1.700	16792	1703
0.375	6591	437	0.750	12574	937	1.130	18225	1507	1.500	23528	2123
0.588	2364	536	1.175	3658	986	1.760	4237	1351	2.350	4463	1629
0.438	2942	410	0.875	5270	773	1.310	7179	1086	1.750	8904	1355
0.450	4891	477	0.900	8981	904	1.350	12536	1280	1.800	15825	1606
0.350	5399	383	0.700	10359	815	1.050	15025	1296	1.400	19545	1826
0.625	2408	406	1.250	3771	748	1.880	4441	1024	2.500	4755	1235
0.600	3755	475	1.200	6297	883	1.800	8031	1225	2.400	9360	1501
0.525	4676	433	1.050	8376	814	1.580	11453	1148	2.100	14152	1426
0.525	5028	493	1.050	9007	928	1.580	12316	1310	2.100	15218	1628
0.450	8757	430	0.900	16634	925	1.350	23923	1486	1.800	30919	2114
0.400	8391	411	0.800	16099	877	1.200	23351	1399	1.600	30376	1974
0.300	11544	458	0.600	22728	946	0.900	33672	1465	1.200	44495	2016
0.650	2861	532	1.300	4432	980	1.950	5144	1342	2.600	5426	1620
0.500	2894	402	1.000	5054	754	1.500	6725	1055	2.000	8152	1306
0.400	7379	393	0.800	14157	837	1.200	20535	1332	1.600	26712	1877
0.700	3678	425	1.400	5933	785	2.100	7239	1081	2.800	8070	1312
0.625	4531	393	1.250	7847	735	1.880	10369	1028	2.500	12451	1265
0.525	7319	378	1.050	13677	823	1.580	19447	1343	2.100	24791	1920
0.675	5401	487	1.350	9196	909	2.030	11936	1268	2.700	14106	1556
0.550	8163	362	1.100	15168	799	1.650	21400	1310	2.200	27245	1895
0.738	3698	544	1.475	5715	1000	2.210	6611	1369	2.950	6950	1652
0.575	4450	434	1.150	7838	814	1.730	10539	1145	2.300	12844	1417

∅ 80 – 150 mm

Article No.	Ordering Dimensions								Weight 1000 pcs. [kg]	Stress σ_{OM} at $s = h_0$ [N/mm ²]
	D_e [mm]	D_i [mm]	t [mm]	t' [mm]	l_0 [mm]	h_0 [mm]	h_0/t	h_0'/t'		
018000	80	41	4		6.2	2.20	0.55		112.6	-1738
018100 A	80	41	5		6.7	1.70	0.34		139.5	-1679
018200 C	90	46	2.5		5.7	3.20	1.28		89.74	-1246
018300 B	90	46	3.5		6	2.50	0.71		125.3	-1363
018400 A	90	46	5		7	2.00	0.40		177.6	-1558
018500	100	41	4		7.2	3.20	0.80		200.0	-1465
018600	100	41	5		7.75	2.75	0.55		248.9	-1574
018750 C	100	51	2.7		6.2	3.50	1.30		120.1	-1191
018800 B	100	51	3.5		6.3	2.80	0.80		155.4	-1235
018900	100	51	4		7	3.00	0.75		177.6	-1512
019000	100	51	5		7.8	2.80	0.56		221.1	-1764
019150 A	100	51	6		8.2	2.20	0.37		262.8	-1663
019250 C	112	57	3		6.9	3.90	1.30		168.0	-1174
019300 B	112	57	4		7.2	3.20	0.80		222.7	-1284
019450 A	112	57	6		8.5	2.50	0.42		332.1	-1505
019500	125	41	4		8.2	4.20	1.05		338.1	-1177
019600	125	51	4		8.5	4.50	1.13		315.6	-1317
019700	125	51	5		8.9	3.90	0.78		391.5	-1426
019850	125	51	6		9.4	3.40	0.57		465.8	-1492
019900	125	61	5		9	4.00	0.80		357.6	-1573
020050	125	61	6		9.6	3.60	0.60		425.4	-1698
020100	125	61	8	7.5	10.9	2.90		0.45	547.3	-1850
020200 C	125	64	3.5		8	4.50	1.29		242.3	-1273
020300 B	125	64	5		8.5	3.50	0.70		346.2	-1415
020400 A	125	64	8	7.5	10.6	2.60		0.41	529.9	-1708
020550	125	71	6		9.3	3.30	0.55		377.9	-1730
020600	125	71	8	7.4	10.4	2.40		0.41	479.6	-1709
020700	125	71	10	9.2	11.8	1.80		0.28	596.3	-1615
020850 C	140	72	3.8		8.7	4.90	1.29		329.7	-1203
020900 B	140	72	5		9	4.00	0.80		433.2	-1293
021000 A	140	72	8	7.5	11.2	3.20		0.49	663.0	-1675
021100	150	61	5		10.3	5.30	1.06		565.0	-1345
021250	150	61	6		10.8	4.80	0.80		676.8	-1462
021350	150	71	6		10.8	4.80	0.80		628.9	-1548
021400	150	71	8	7.5	12	4.00		0.60	803.6	-1733

Deflection s, Load F and Stress σ

at $s = 0.25 h_0$			$s = 0.50 h_0$			$s \approx 0.75 h_0$			$s = 1.00 h_0$		
s	F	σ	s	F	σ	s	F	σ	s	F	σ
[mm]	[N]	[N/mm ²]	[mm]	[N]	[N/mm ²]	[mm]	[N]	[N/mm ²]	[mm]	[N]	[N/mm ²]
0.550	8726	486	1.100	16213	924	1.650	22874	1314	2.200	29122	1655
0.425	11821	439	0.850	22928	924	1.280	33682	1460	1.700	43952	2028
0.800	4232	509	1.600	6585	938	2.400	7684	1286	3.200	8157	1553
0.625	5836	421	1.250	10416	792	1.880	14189	1116	2.500	17487	1387
0.500	11267	382	1.000	21617	814	1.500	31354	1295	2.000	40786	1826
0.800	8714	437	1.600	15219	818	2.400	20251	1144	3.200	24547	1414
0.688	12345	374	1.375	22937	823	2.060	32328	1344	2.750	41201	1944
0.875	4779	490	1.750	7410	902	2.630	8613	1237	3.500	9091	1491
0.700	5624	399	1.400	9823	749	2.100	13070	1049	2.800	15843	1298
0.750	8673	476	1.500	15341	894	2.250	20674	1255	3.000	25338	1559
0.700	13924	496	1.400	25810	942	2.100	36339	1337	2.800	46189	1683
0.550	17061	424	1.100	32937	897	1.650	48022	1418	2.200	62711	1987
0.975	5834	483	1.950	9038	889	2.930	10493	1220	3.900	11064	1470
0.800	7639	415	1.600	13341	778	2.400	17752	1090	3.200	21518	1349
0.625	15800	363	1.250	30215	777	1.880	43812	1243	2.500	56737	1752
1.050	8501	370	2.100	13943	685	3.150	17346	945	4.200	19729	1150
1.125	10096	463	2.250	16265	856	3.380	19829	1179	4.500	22060	1431
0.975	13063	420	1.950	22931	787	2.930	30705	1103	3.900	37342	1363
0.850	17027	349	1.700	31514	770	2.550	44307	1264	3.400	56254	1832
1.000	14615	500	2.000	25526	938	3.000	33965	1312	4.000	41170	1624
0.900	19789	481	1.800	36336	911	2.700	50722	1290	3.600	64028	1619
0.725	34434	415	1.450	65305	893	2.180	93765	1436	2.900	120218	2034
1.125	8514	522	2.250	13231	961	3.380	15422	1319	4.500	16335	1591
0.875	12238	433	1.750	21924	816	2.630	29950	1151	3.500	37041	1432
0.650	31118	391	1.300	59520	833	1.950	85926	1326	2.600	111056	1870
0.825	19538	504	1.650	36302	959	2.480	51304	1366	3.300	65207	1718
0.600	30867	470	1.200	59149	908	1.800	85494	1314	2.400	110547	1688
0.450	42963	401	0.900	84219	829	1.350	124124	1284	1.800	163035	1766
1.225	9514	495	2.450	14773	911	3.680	17201	1250	4.900	18199	1508
1.000	12014	419	2.000	20982	787	3.000	27920	1101	4.000	33843	1363
0.800	31903	467	1.600	59967	895	2.400	85251	1284	3.200	108813	1634
1.325	15292	458	2.650	25021	848	3.980	31059	1172	5.300	35207	1426
1.200	19560	435	2.400	34161	814	3.600	45456	1138	4.800	55098	1406
1.200	20721	487	2.400	36189	913	3.600	48155	1277	4.800	58370	1580
1.000	35296	501	2.000	64684	954	3.000	89851	1357	4.000	112487	1711

∅ 150 – 250 mm

Article No.	Ordering Dimensions								Weight 1000 pcs. [kg]	Stress σ_{OM} at $s = h_0$ [N/mm ²]
	D_e [mm]	D_i [mm]	t [mm]	t' [mm]	l_0 [mm]	h_0 [mm]	h_0/t	h_0'/t'		
021500	150	81	8	7.5	11.7	3.70		0.56	732.9	-1739
021600	150	81	10	9.3	13	3.00		0.40	908.8	-1779
021650 C	160	82	4.3		9.9	5.60	1.30		492.2	-1189
021750 B	160	82	6		10.5	4.50	0.75		679.8	-1333
021800 A	160	82	10	9.4	13.5	3.50		0.44	1089	-1753
021850 C	180	92	4.8		11	6.20	1.29		705.3	-1159
021950 B	180	92	6		11.1	5.10	0.85		862.5	-1192
022000 A	180	92	10	9.4	14	4.00		0.49	1381	-1576
022100	200	82	8	7.6	14.2	6.20		0.87	1554	-1415
022200	200	82	10	9.6	15.5	5.50		0.61	1962	-1581
022300	200	82	12	11.5	16.6	4.60		0.44	2351	-1595
022400	200	92	10	9.5	15.6	5.60		0.64	1840	-1679
022500	200	92	12	11.4	16.8	4.80		0.47	2208	-1737
022600	200	92	14	13.1	18.1	4.10		0.38	2537	-1743
022650 C	200	102	5.5		12.5	7.00	1.27		999.3	-1213
022700 B	200	102	8	7.5	13.6	5.60		0.81	1363	-1409
022800	200	102	10	9.4	15.6	5.60		0.66	1708	-1772
022900 A	200	102	12	11.25	16.2	4.20		0.44	2044	-1611
023000	200	102	14	13.1	18.2	4.20		0.39	2380	-1884
023100	200	112	12	11.1	16.2	4.20		0.46	1870	-1726
023200	200	112	14	12.9	17.5	3.50		0.36	2173	-1689
023300	200	112	16	14.8	18.8	2.80		0.27	2493	-1550
023350 C	225	112	6.5	6.2	13.6	7.10		1.19	1450	-1119
023400 B	225	112	8	7.5	14.5	6.50		0.93	1754	-1267
023500 A	225	112	12	11.25	17	5.00		0.51	2631	-1489
023600	250	102	10	9.6	18	8.00		0.88	3075	-1459
023700	250	102	12	11.5	19	7.00		0.65	3683	-1542
023750 C	250	127	7	6.7	14.8	7.80		1.21	1909	-1086
023800 B	250	127	10	9.4	17	7.00		0.81	2678	-1406
023900	250	127	12	11.25	19.3	7.30		0.72	3205	-1766
024000 A	250	127	14	13.1	19.6	5.60		0.50	3732	-1596
024100	250	127	16	15	21.8	5.80		0.45	4273	-1893

Deflection s, Load F and Stress σ

at $s = 0.25 h_0$			$s = 0.50 h_0$			$s \approx 0.75 h_0$			$s = 1.00 h_0$		
s	F	σ	s	F	σ	s	F	σ	s	F	σ
[mm]	[N]	[N/mm ²]	[mm]	[N]	[N/mm ²]	[mm]	[N]	[N/mm ²]	[mm]	[N]	[N/mm ²]
0.925	34518	516	1.850	63876	985	2.780	89663	1409	3.700	112942	1781
0.750	50088	399	1.500	96120	846	2.250	139128	1342	3.000	180141	1887
1.400	12162	491	2.800	18832	904	4.200	21843	1238	5.600	23022	1494
1.125	17203	420	2.250	30431	790	3.380	41051	1110	4.500	50260	1377
0.875	50547	390	1.750	96216	836	2.630	138564	1341	3.500	178214	1896
1.550	14646	476	3.100	22731	877	4.650	26442	1201	6.200	27966	1450
1.275	16558	396	2.550	28552	742	3.830	37533	1036	5.100	44930	1278
1.000	46850	437	2.000	88141	837	3.000	125417	1201	4.000	160223	1528
1.550	35029	450	3.100	60013	842	4.650	78034	1177	6.200	92176	1455
1.375	51105	329	2.750	93357	739	4.130	129569	1233	5.500	162061	1804
1.150	66924	416	2.300	127191	890	3.450	182737	1421	4.600	235503	2011
1.400	55136	490	2.800	100014	928	4.200	137688	1315	5.600	171214	1651
1.200	73913	400	2.400	139548	864	3.600	199269	1393	4.800	255443	1985
1.025	95633	445	2.050	184092	938	3.080	267623	1484	4.100	346888	2072
1.750	19817	494	3.500	30882	910	5.250	36111	1247	7.000	38423	1507
1.400	33367	475	2.800	57955	892	4.200	76378	1254	5.600	91252	1559
1.400	58757	546	2.800	106099	1036	4.200	145357	1468	5.600	179858	1844
1.050	66983	357	2.100	127401	766	3.150	183020	1227	4.200	235610	1739
1.050	103781	445	2.100	199476	943	3.150	289181	1492	4.200	374993	2094
1.050	72257	490	2.100	136873	943	3.150	195830	1358	4.200	251108	1736
0.875	91033	387	1.750	176156	813	2.630	257208	1281	3.500	334227	1782
0.700	105268	395	1.400	206697	815	2.100	305100	1260	2.800	401294	1730
1.775	23582	446	3.550	37417	825	5.330	44594	1138	7.100	48147	1383
1.625	32870	450	3.250	55412	842	4.880	70788	1177	6.500	82002	1451
1.250	64497	415	2.500	120738	794	3.750	171016	1137	5.000	217625	1444
2.000	56867	462	4.000	97282	865	6.000	126387	1207	8.000	149323	1490
1.750	73563	303	3.500	133130	691	5.250	182962	1163	7.000	227317	1720
1.950	26895	438	3.900	42527	810	5.850	50466	1116	7.800	54284	1356
1.750	51871	471	3.500	90206	886	5.250	119053	1244	7.000	142462	1547
1.825	87633	563	3.650	156021	1063	5.480	210942	1503	7.300	257630	1879
1.400	93239	444	2.800	175145	851	4.200	248828	1221	5.600	317399	1554
1.450	140941	413	2.900	267295	890	4.350	383017	1429	5.800	492058	2031

9.3 Dimension Tables for Corrosion Resistant SCHNORR Disc Springs

Article No.	Ordering Dimensions						Weight/ 1000 pcs. [kg]	Stress σ_{OM} at $s = h_0$ [N/mm ²]
	D_e [mm]	D_i [mm]	t [mm]	l_0 [mm]	h_0 [mm]	h_0/t		
024 650	6	3.2	0.3	0.45	0.15	0.50	0.047	-1497
025 250	8	3.2	0.2	0.4	0.2	1.00	0.066	-655
025 400	8	3.2	0.3	0.55	0.25	0.83	0.098	-1228
025 700	8	3.2	0.4	0.55	0.15	0.38	0.131	-983
026 300	8	3.2	0.5	0.7	0.2	0.40	0.166	-1638
026 700	8	4.2	0.2	0.45	0.25	1.25	0.057	-925
027 100	8	4.2	0.3	0.5	0.2	0.67	0.085	-1110
027 400	8	4.2	0.4	0.6	0.2	0.50	0.113	-1480
028 910	10	3.2	0.3	0.65	0.35	1.17	0.165	-1058
029 101	10	3.2	0.4	0.7	0.3	0.75	0.220	-1209
029 301	10	3.2	0.5	0.7	0.2	0.40	0.274	-1007
029 602	10	4.2	0.4	0.65	0.25	0.63	0.202	-1064
029 701	10	4.2	0.5	0.7	0.2	0.40	0.252	-1064
030 290	10	5.2	0.25	0.55	0.3	1.20	0.112	-883
030 800	10	5.2	0.4	0.65	0.25	0.63	0.179	-1177
031 000	10	5.2	0.5	0.7	0.2	0.40	0.223	-1177
032 040	12	4.2	0.4	0.8	0.4	1.00	0.309	-1132
032 500	12	4.2	0.5	0.8	0.3	0.60	0.386	-1061
032 704	12	4.2	0.6	0.85	0.25	0.42	0.463	-1061
033 400	12	5.2	0.5	0.8	0.3	0.60	0.357	-1120
033 500	12	5.2	0.6	0.85	0.25	0.42	0.429	-1120
034 200	12	6.2	0.5	0.85	0.35	0.70	0.323	-1424
034 550	12	6.2	0.6	0.85	0.25	0.42	0.387	-1221
035 040	12.5	5.2	0.5	0.85	0.35	0.70	0.395	-1188
035 103	12.5	6.2	0.35	0.8	0.45	1.29	0.253	-1152
035 400	12.5	6.2	0.5	0.85	0.35	0.70	0.361	-1281
035 601	12.5	6.2	0.7	0.95	0.25	0.36	0.504	-1281
038 353	14	7.2	0.35	0.8	0.45	1.29	0.310	-939
038 600	14	7.2	0.5	0.9	0.4	0.80	0.442	-1192
039 040	14	7.2	0.8	1.05	0.25	0.31	0.706	-1192
039 500	15	5.2	0.4	0.95	0.55	1.38	0.486	-995
039 800	15	5.2	0.5	1	0.5	1.00	0.607	-1131
039 971	15	5.2	0.6	1.05	0.45	0.75	0.728	-1221

∅ 6 – 15 mm Material: 1.4310 (X 10 CrNi 18-8)

Deflection s, Load F and Stress σ

at $s = 0.25 h_0$			$s = 0.50 h_0$			$s \approx 0.75 h_0$			$s = 1.00 h_0$		
s	F	σ	s	F	σ	s	F	σ	s	F _c	σ
[mm]	[N]	[N/mm ²]	[mm]	[N]	[N/mm ²]	[mm]	[N]	[N/mm ²]	[mm]	[N]	[N/mm ²]
0.038	43	412	0.075	81	786	0.113	116	1125	0.150	148	1617
0.050	12	215	0.100	20	400	0.150	25	553	0.200	29	676
0.063	44	370	0.125	77	691	0.188	101	965	0.250	122	1299
0.038	47	290	0.075	91	612	0.113	133	966	0.150	173	1353
0.050	125	471	0.100	239	999	0.150	347	1584	0.200	451	2226
0.063	21	377	0.125	32	695	0.188	38	954	0.250	41	1154
0.050	36	337	0.100	64	636	0.150	88	897	0.200	110	1120
0.050	76	405	0.100	143	772	0.150	203	1124	0.200	261	1615
0.088	50	349	0.175	79	643	0.263	95	883	0.350	105	1068
0.075	73	321	0.150	129	611	0.225	174	1046	0.300	213	1566
0.050	77	336	0.100	147	710	0.150	213	1122	0.200	278	1573
0.063	59	289	0.125	108	546	0.188	149	845	0.250	188	1240
0.050	81	296	0.100	155	629	0.150	225	998	0.200	293	1403
0.075	30	350	0.150	47	647	0.225	56	890	0.300	61	1079
0.063	65	347	0.125	119	656	0.188	165	928	0.250	208	1198
0.050	90	300	0.100	172	608	0.150	249	968	0.200	324	1365
0.100	83	355	0.200	137	659	0.300	173	911	0.400	200	1174
0.075	90	265	0.150	166	589	0.225	232	971	0.300	293	1411
0.063	117	328	0.125	224	696	0.188	324	1105	0.250	421	1554
0.075	95	303	0.150	175	574	0.225	244	889	0.300	309	1298
0.063	124	300	0.125	237	640	0.188	342	1018	0.250	444	1437
0.088	130	438	0.175	232	825	0.263	317	1161	0.350	392	1447
0.063	135	314	0.125	258	624	0.188	373	996	0.250	484	1408
0.088	108	336	0.175	194	633	0.263	264	892	0.350	327	1332
0.113	81	467	0.225	126	860	0.338	147	1178	0.450	156	1423
0.088	117	387	0.175	209	730	0.263	285	1027	0.350	353	1282
0.063	187	336	0.125	362	708	0.188	529	1117	0.250	692	1563
0.113	66	386	0.225	103	710	0.338	120	973	0.450	127	1175
0.100	117	387	0.200	204	725	0.300	271	1016	0.400	329	1258
0.063	224	320	0.125	436	670	0.188	640	1049	0.250	841	1458
0.138	98	370	0.275	150	678	0.413	170	924	0.550	175	1109
0.125	129	353	0.250	214	655	0.375	270	906	0.500	312	1180
0.113	166	333	0.225	293	625	0.338	395	998	0.450	485	1499

∅ 15 – 20 mm Material: 1.4310 (X 10 CrNi 18-8)

Article No.	Ordering Dimensions						Weight/ 1000 pcs. [kg]	Stress σ_{OM} at $s = h_0$ [N/mm ²]
	D _e [mm]	D _i [mm]	t [mm]	l ₀ [mm]	h ₀ [mm]	h ₀ /t		
040 130	15	5.2	0.7	1.05	0.35	0.50	0.849	-1108
040 950	15	6.2	0.5	1	0.50	1.00	0.572	-1176
041 301	15	6.2	0.6	1	0.40	0.67	0.687	-1129
041 700	15	6.2	0.7	1.05	0.35	0.50	0.801	-1152
042 400	15	8.2	0.7	1	0.30	0.43	0.677	-1138
042 601	15	8.2	0.8	1.1	0.30	0.38	0.773	-1301
043 750	16	8.2	0.4	0.9	0.50	1.25	0.464	-911
044 000	16	8.2	0.6	1.05	0.45	0.75	0.695	-1230
044 101	16	8.2	0.7	1.05	0.35	0.50	0.811	-1116
044 201	16	8.2	0.8	1.1	0.30	0.38	0.926	-1093
044 400	16	8.2	0.9	1.2	0.30	0.33	1.042	-1230
045 800	18	6.2	0.4	1	0.60	1.50	0.702	-753
046 003	18	6.2	0.5	1.1	0.60	1.20	0.878	-941
046 252	18	6.2	0.6	1.2	0.60	1.00	1.053	-1129
046 400	18	6.2	0.7	1.25	0.55	0.79	1.228	-1208
046 505	18	6.2	0.8	1.3	0.50	0.63	1.403	-1255
046 924	18	8.2	0.5	1.1	0.60	1.20	0.789	-1015
047 070	18	8.2	0.7	1.2	0.50	0.71	1.104	-1184
047 300	18	8.2	0.8	1.25	0.45	0.56	1.262	-1218
047 691	18	8.2	1	1.35	0.35	0.35	1.576	-1184
047 910	18	9.2	0.45	1.05	0.60	1.33	0.662	-970
048 050	18	9.2	0.7	1.2	0.50	0.71	1.029	-1257
048 098	18	9.2	1	1.35	0.35	0.35	1.469	-1257
048 051	20	8.2	0.5	1.15	0.65	1.30	1.029	-858
051 100	20	8.2	0.6	1.3	0.70	1.17	1.226	-1108
052 270	20	8.2	0.7	1.35	0.65	0.93	1.430	-1201
051 450	20	8.2	0.8	1.35	0.55	0.69	1.634	-1161
051 701	20	8.2	0.9	1.45	0.55	0.61	1.838	-1306
051 761	20	8.2	1	1.45	0.45	0.45	2.042	-1188
052 803	20	10.2	0.5	1.15	0.65	1.30	0.910	-944
052 804	20	10.2	0.6	1.2	0.60	1.00	1.098	-1046
053 500	20	10.2	0.8	1.35	0.55	0.69	1.454	-1279
053 701	20	10.2	0.9	1.4	0.50	0.56	1.635	-1308
053 901	20	10.2	1	1.4	0.40	0.40	1.817	-1162
054 380	20	10.2	1.1	1.5	0.40	0.36	1.998	-1279

Deflection s , Load F and Stress σ

at $s = 0.25 h_0$			$s = 0.50 h_0$			$s \approx 0.75 h_0$			$s = 1.00 h_0$		
s	F	σ	s	F	σ	s	F	σ	s	F_c	σ
[mm]	[N]	[N/mm ²]	[mm]	[N]	[N/mm ²]	[mm]	[N]	[N/mm ²]	[mm]	[N]	[N/mm ²]
0.088	174	315	0.175	327	680	0.263	466	1096	0.350	598	1564
0.125	134	391	0.250	223	726	0.375	281	1005	0.500	324	1228
0.100	145	313	0.200	261	589	0.300	359	876	0.400	448	1297
0.088	181	290	0.175	340	629	0.263	485	1018	0.350	622	1456
0.075	172	302	0.150	329	578	0.225	474	890	0.300	615	1262
0.075	251	332	0.150	483	667	0.225	704	1057	0.300	918	1485
0.125	81	368	0.250	127	678	0.375	150	930	0.500	161	1125
0.113	167	388	0.225	295	728	0.338	398	1023	0.450	488	1270
0.088	175	302	0.175	330	576	0.263	470	860	0.350	603	1235
0.075	211	275	0.150	406	583	0.225	591	923	0.300	771	1296
0.075	294	324	0.150	572	680	0.225	838	1069	0.300	1098	1490
0.150	82	294	0.300	122	538	0.450	135	730	0.600	133	871
0.150	126	323	0.300	200	595	0.450	238	817	0.600	259	987
0.150	186	352	0.300	308	653	0.450	389	903	0.600	448	1184
0.138	229	336	0.275	402	629	0.413	537	962	0.550	652	1457
0.125	278	317	0.250	508	687	0.375	705	1139	0.500	885	1663
0.150	136	384	0.300	215	709	0.450	257	974	0.600	280	1179
0.125	213	350	0.250	381	658	0.375	518	925	0.500	640	1241
0.113	259	328	0.225	481	623	0.338	676	964	0.450	859	1398
0.088	353	330	0.175	683	694	0.263	998	1093	0.350	1306	1526
0.150	117	406	0.300	180	746	0.450	207	1020	0.600	217	1230
0.125	227	388	0.250	405	730	0.375	550	1028	0.500	679	1279
0.088	374	326	0.175	725	687	0.263	1059	1083	0.350	1386	1513
0.163	125	327	0.325	193	601	0.488	224	822	0.650	236	991
0.175	208	398	0.350	332	735	0.525	400	1010	0.700	440	1224
0.163	254	384	0.325	429	715	0.488	552	993	0.650	649	1218
0.138	268	325	0.275	482	611	0.413	660	890	0.550	819	1324
0.138	363	349	0.275	665	659	0.413	926	1066	0.550	1166	1559
0.113	371	318	0.225	704	682	0.338	1013	1093	0.450	1309	1549
0.163	137	389	0.325	213	716	0.488	247	981	0.650	260	1184
0.150	172	375	0.300	285	698	0.450	360	968	0.600	415	1184
0.138	295	388	0.275	531	732	0.413	726	1031	0.550	902	1286
0.125	351	366	0.250	651	696	0.375	918	989	0.500	1168	1405
0.100	354	294	0.200	679	608	0.300	985	968	0.400	1281	1364
0.100	463	327	0.200	895	691	0.300	1305	1092	0.400	1705	1530

∅ 20 – 31.5 mm Material: 1.4310 (X 10 CrNi 18-8)

Article No.	Ordering Dimensions						Weight/ 1000 pcs. [kg]	Stress σ_{OM} at $s = h_0$ [N/mm ²]
	D _e [mm]	D _i [mm]	t [mm]	l ₀ [mm]	h ₀ [mm]	h ₀ /t		
055 280	20	10.2	1.25	1.55	0.30	0.24	2.269	-1090
055 650	20	10.2	1.5	1.75	0.25	0.17	2.721	-1090
057 710	22.5	11.2	0.6	1.4	0.80	1.33	1.406	-1086
057 903	22.5	11.2	0.8	1.45	0.65	0.81	1.873	-1177
058 050	22.5	11.2	1.25	1.65	0.40	0.32	2.924	-1132
058 950	23	8.2	0.7	1.5	0.80	1.14	1.987	-1082
059 210	23	8.2	0.8	1.55	0.75	0.94	2.271	-1159
059 400	23	8.2	0.9	1.6	0.70	0.78	2.554	-1217
059 504	23	8.2	1	1.6	0.60	0.60	2.838	-1159
060 460	23	10.2	0.9	1.65	0.75	0.83	2.352	-1384
060 600	23	10.2	1	1.6	0.60	0.60	2.613	-1230
060 901	23	10.2	1.25	1.7	0.45	0.36	3.264	-1153
001 922	23	12.2	1	1.6	0.60	0.60	2.337	-1353
061 600	23	12.2	1.25	1.65	0.40	0.32	2.919	-1127
061 951	23	12.2	1.5	1.85	0.35	0.23	3.501	-1184
063 872	25	10.2	1	1.7	0.70	0.70	3.205	-1181
064 400	25	12.2	0.7	1.6	0.90	1.29	2.052	-1142
064 900	25	12.2	0.9	1.6	0.70	0.78	2.637	-1142
065 104	25	12.2	1	1.65	0.65	0.65	2.929	-1178
065 129	25	12.2	1.25	1.75	0.50	0.40	3.660	-1133
065 400	25	12.2	1.5	1.95	0.45	0.30	4.389	-1224
071 600	28	10.2	0.8	1.75	0.95	1.19	3.351	-995
071 752	28	10.2	1	1.9	0.90	0.90	4.188	-1178
072 001	28	10.2	1.25	1.95	0.70	0.56	5.232	-1145
072 105	28	10.2	1.5	2.1	0.60	0.40	6.277	-1178
072 750	28	12.2	1	1.95	0.95	0.95	3.911	-1305
072 860	28	12.2	1.25	1.95	0.70	0.56	4.887	-1202
073 300	28	12.2	1.5	2.05	0.55	0.37	5.862	-1133
075 260	28	14.2	0.8	1.8	1.00	1.25	2.870	-1182
075 700	28	14.2	1	1.8	0.80	0.80	3.586	-1182
075 925	28	14.2	1.25	1.9	0.65	0.52	4.480	-1200
076 160	28	14.2	1.5	2.05	0.55	0.37	5.373	-1219
082 253	31.5	12.2	1	2.1	1.10	1.10	5.191	-1153
081 505	31.5	12.2	1.25	2.15	0.90	0.72	6.486	-1179
082 303	31.5	12.2	1.5	2.25	0.75	0.50	7.781	-1179

Deflection s, Load F and Stress σ

at $s = 0.25 h_0$			$s = 0.50 h_0$			$s \approx 0.75 h_0$			$s = 1.00 h_0$		
s	F	σ	s	F	σ	s	F	σ	s	F _c	σ
[mm]	[N]	[N/mm ²]	[mm]	[N]	[N/mm ²]	[mm]	[N]	[N/mm ²]	[mm]	[N]	[N/mm ²]
0.075	487	316	0.150	959	653	0.225	1420	1011	0.300	1877	1389
0.063	688	338	0.125	1365	691	0.188	2036	1058	0.250	2703	1440
0.200	233	450	0.400	359	827	0.600	413	1132	0.800	431	1364
0.163	297	380	0.325	518	712	0.488	687	995	0.650	830	1231
0.100	520	308	0.200	1012	645	0.300	1485	1010	0.400	1949	1405
0.200	271	366	0.400	435	676	0.600	528	929	0.800	584	1126
0.188	322	354	0.375	544	659	0.563	698	914	0.750	818	1238
0.175	380	341	0.350	667	639	0.525	892	952	0.700	1087	1442
0.150	395	292	0.300	725	635	0.450	1012	1047	0.600	1278	1523
0.188	450	433	0.375	779	809	0.563	1027	1130	0.750	1235	1395
0.150	419	336	0.300	769	636	0.450	1074	961	0.600	1356	1405
0.113	539	324	0.225	1041	682	0.338	1520	1075	0.450	1986	1502
0.150	461	396	0.300	846	750	0.450	1181	1063	0.600	1491	1382
0.100	518	295	0.200	1008	618	0.300	1480	969	0.400	1942	1349
0.088	760	338	0.175	1498	697	0.263	2221	1078	0.350	2936	1480
0.175	430	332	0.350	770	625	0.525	1051	899	0.700	1301	1341
0.225	322	460	0.450	500	847	0.675	582	1161	0.900	617	1401
0.175	356	359	0.350	626	674	0.525	837	944	0.700	1020	1170
0.163	415	344	0.325	752	650	0.488	1039	917	0.650	1299	1230
0.125	539	286	0.250	1034	609	0.375	1500	969	0.500	1952	1365
0.113	706	344	0.225	1385	717	0.338	2046	1120	0.450	2698	1553
0.238	338	346	0.475	536	638	0.713	642	876	0.950	702	1060
0.225	497	356	0.450	846	662	0.675	1097	921	0.900	1298	1271
0.175	715	292	0.350	1300	643	0.525	1799	1051	0.700	2254	1517
0.150	807	360	0.300	1548	763	0.450	2246	1208	0.600	2922	1696
0.238	573	431	0.475	963	802	0.713	1231	1114	0.950	1439	1365
0.175	624	318	0.350	1157	603	0.525	1629	981	0.700	2071	1421
0.138	765	319	0.275	1477	674	0.413	2153	1063	0.550	2811	1487
0.250	422	475	0.500	661	876	0.750	778	1203	1.000	834	1454
0.200	463	382	0.400	808	715	0.600	1075	1001	0.800	1303	1240
0.163	609	328	0.325	1139	625	0.488	1616	917	0.650	2068	1322
0.138	1003	312	0.275	1912	659	0.413	2758	1042	0.550	3573	1461
0.275	570	393	0.550	923	727	0.825	1133	1002	1.100	1270	1218
0.225	680	329	0.450	1212	618	0.675	1646	914	0.900	2030	1368
0.188	851	310	0.375	1599	672	0.563	2278	1085	0.750	2924	1551

∅ 31.5 – 50 mm Material: 1.4310 (X 10 CrNi 18-8)

Article No.	Ordering Dimensions						Weight/ 1000 pcs. [kg]	Stress σ_{OM} at $s = h_0$ [N/mm ²]
	D_e [mm]	D_i [mm]	t [mm]	l_0 [mm]	h_0 [mm]	h_0/t		
082 801	31.5	16.3	0.8	1.85	1.05	1.31	3.577	-993
083 370	31.5	16.3	1.25	2	0.75	0.60	5.584	-1108
083 800	31.5	16.3	1.5	2.15	0.65	0.43	6.698	-1153
084 493	31.5	16.3	1.75	2.3	0.55	0.31	7.811	-1138
084 800	31.5	16.3	2	2.5	0.50	0.25	8.923	-1182
087 900	34	12.3	1	2.25	1.25	1.25	6.187	-1108
088 046	34	12.3	1.25	2.35	1.10	0.88	7.732	-1219
088 300	34	12.3	1.5	2.4	0.90	0.60	9.275	-1197
089 321	34	14.3	1.25	2.3	1.05	0.84	7.321	-1208
089 400	34	14.3	1.5	2.35	0.85	0.57	8.783	-1174
090 500	34	16.3	1.5	2.3	0.80	0.53	8.216	-1165
091 100	34	16.3	2	2.6	0.60	0.30	10.946	-1165
004 543	35.5	18.3	0.9	2.05	1.15	1.28	5.132	-961
094 000	35.5	18.3	1.25	2.25	1.00	0.72	7.124	-1161
093 683	35.5	18.3	2	2.65	0.65	0.33	11.385	-1207
099 423	40	14.3	1.25	2.65	1.40	1.12	10.752	-1118
099 461	40	14.3	1.5	2.75	1.25	0.83	12.899	-1198
099 833	40	14.3	2	2.9	0.90	0.45	17.189	-1150
100 503	40	16.3	1.5	2.7	1.20	0.80	12.332	-1185
100 801	40	16.3	2	2.9	0.90	0.45	16.433	-1185
101 755	40	18.3	2	2.85	0.85	0.43	15.584	-1167
102 531	40	20.4	1	2.3	1.30	1.30	7.300	-944
103 000	40	20.4	1.5	2.6	1.10	0.73	10.942	-1199
103 500	40	20.4	2	2.8	0.80	0.40	14.580	-1162
103 953	40	20.4	2.25	2.95	0.70	0.31	16.397	-1144
104 465	40	20.4	2.5	3.15	0.65	0.26	18.212	-1180
110 412	45	22.4	1.25	2.9	1.65	1.32	11.746	-1167
110 501	45	22.4	1.75	2.95	1.20	0.69	16.434	-1188
110 901	45	22.4	2.5	3.35	0.85	0.34	23.457	-1202
115 970	50	18.4	1.25	2.85	1.60	1.28	16.679	-822
116 300	50	18.4	1.5	3.3	1.80	1.20	20.011	-1110
116 653	50	18.4	2	3.45	1.45	0.73	26.669	-1193
116 901	50	18.4	2.5	3.65	1.15	0.46	33.323	-1182
117 400	50	20.4	2	3.4	1.40	0.70	25.710	-1181
117 703	50	20.4	2.5	3.6	1.10	0.44	32.123	-1160

Deflection s, Load F and Stress σ

at $s = 0.25 h_0$			$s = 0.50 h_0$			$s \approx 0.75 h_0$			$s = 1.00 h_0$		
s	F	σ	s	F	σ	s	F	σ	s	F _c	σ
[mm]	[N]	[N/mm ²]	[mm]	[N]	[N/mm ²]	[mm]	[N]	[N/mm ²]	[mm]	[N]	[N/mm ²]
0.263	373	413	0.525	577	761	0.788	667	1042	1.050	701	1257
0.188	590	321	0.375	1083	608	0.563	1512	862	0.750	1909	1149
0.163	803	300	0.325	1530	580	0.488	2207	928	0.650	2859	1317
0.138	1023	304	0.275	1992	636	0.413	2925	997	0.550	3841	1385
0.125	1357	337	0.250	2667	697	0.375	3948	1080	0.500	5213	1487
0.313	619	396	0.625	969	728	0.938	1140	997	1.250	1221	1203
0.275	792	363	0.550	1355	677	0.825	1765	942	1.100	2099	1339
0.225	917	303	0.450	1684	649	0.675	2351	1071	0.900	2968	1557
0.263	761	372	0.525	1316	695	0.788	1733	970	1.050	2081	1230
0.213	881	307	0.425	1631	593	0.638	2293	975	0.850	2911	1413
0.200	858	314	0.400	1599	598	0.600	2264	913	0.800	2891	1318
0.150	1361	331	0.300	2656	691	0.450	3908	1078	0.600	5139	1495
0.288	444	394	0.575	692	725	0.863	808	994	1.150	858	1201
0.250	603	377	0.500	1074	707	0.750	1459	990	1.000	1799	1225
0.163	1423	320	0.325	2767	670	0.488	4058	1052	0.650	5322	1464
0.350	878	375	0.700	1416	692	1.050	1728	953	1.400	1926	1156
0.313	1082	347	0.625	1873	648	0.938	2471	903	1.250	2972	1368
0.225	1437	338	0.450	2729	723	0.675	3925	1155	0.900	5073	1634
0.300	1044	353	0.600	1823	661	0.900	2426	924	1.200	2940	1265
0.225	1480	319	0.450	2812	684	0.675	4044	1095	0.900	5227	1552
0.213	1439	299	0.425	2747	639	0.638	3968	1020	0.850	5146	1442
0.325	549	389	0.650	850	716	0.975	987	981	1.300	1041	1184
0.275	1006	374	0.550	1786	703	0.825	2417	987	1.100	2973	1228
0.200	1416	294	0.400	2716	608	0.600	3940	968	0.800	5125	1364
0.175	1698	309	0.350	3308	647	0.525	4861	1013	0.700	6385	1407
0.163	2123	336	0.325	4170	696	0.488	6164	1081	0.650	8133	1490
0.413	1011	481	0.825	1573	884	1.238	1836	1210	1.650	1949	1458
0.300	1312	357	0.600	2359	673	0.900	3229	948	1.200	4011	1197
0.213	2228	320	0.425	4321	673	0.638	6324	1059	0.850	8283	1477
0.400	735	299	0.800	1144	550	1.200	1334	753	1.600	1417	907
0.450	1339	390	0.900	2121	719	1.350	2530	986	1.800	2754	1192
0.363	1768	328	0.725	3148	616	1.088	4268	954	1.450	5259	1428
0.288	2319	337	0.575	4396	723	0.863	6311	1157	1.150	8146	1641
0.350	1720	332	0.700	3081	625	1.050	4203	899	1.400	5206	1341
0.275	2251	315	0.550	4284	674	0.825	6173	1078	1.100	7989	1525

∅ 50 – 90 mm Material: 1.4310 (X 10 CrNi 18-8)

Article No.	Ordering Dimensions						Weight/ 1000 pcs. [kg]	Stress σ_{OM} at $s = h_0$ [N/mm ²]
	D_e [mm]	D_i [mm]	t [mm]	l_0 [mm]	h_0 [mm]	h_0/t		
118 401	50	22.4	2	3.3	1.30	0.65	24.652	-1132
000 227	50	22.4	2.5	3.6	1.10	0.44	30.800	-1198
119 950	50	25.4	1.25	2.85	1.60	1.28	14.311	-928
120 103	50	25.4	1.5	3.1	1.60	1.07	17.168	-1113
120 400	50	25.4	2	3.3	1.30	0.65	22.878	-1206
120 801	50	25.4	2.5	3.5	1.00	0.40	28.582	-1160
128 599	56	28.5	1.5	3.45	1.95	1.30	21.495	-1083
128 600	56	28.5	2	3.6	1.60	0.80	28.646	-1185
131 001	60	20.5	2	4.1	2.10	1.05	39.235	-1185
003 158	60	20.5	2.5	4.05	1.55	0.62	49.027	-1093
131 801	60	25.5	2.5	4.1	1.60	0.64	45.471	-1186
113 193	60	30.5	2.5	4	1.50	0.60	41.157	-1208
138 221	63	31	1.8	4.1	2.30	1.28	33.419	-1187
138 503	63	31	2.5	4.15	1.65	0.66	46.389	-1183
144 401	70	25.5	2	4.5	2.50	1.25	52.479	-1047
146 250	70	30.5	2.5	4.7	2.20	0.88	61.266	-1209
153 014	71	36	2	4.6	2.60	1.30	46.249	-1195
153 110	71	36	2.5	4.5	2.00	0.80	57.789	-1149
159 600	80	31	2.5	5.3	2.80	1.12	84.001	-1137
161 220	80	41	2.25	5.2	2.95	1.31	65.586	-1209
169 200	90	46	2.5	5.7	3.20	1.28	92.370	-1150

Deflection s, Load F and Stress σ

at $s = 0.25 h_0$			$s = 0.50 h_0$			$s \approx 0.75 h_0$			$s = 1.00 h_0$		
s	F	σ	s	F	σ	s	F	σ	s	F _c	σ
[mm]	[N]	[N/mm ²]	[mm]	[N]	[N/mm ²]	[mm]	[N]	[N/mm ²]	[mm]	[N]	[N/mm ²]
0.325	1594	320	0.650	2892	604	0.975	3992	852	1.300	4993	1248
0.275	2325	306	0.550	4425	656	0.825	6376	1049	1.100	8251	1487
0.400	829	378	0.800	1290	697	1.200	1505	955	1.600	1598	1153
0.400	1206	412	0.800	1969	764	1.200	2439	1056	1.600	2761	1288
0.325	1698	358	0.650	3080	675	0.975	4251	954	1.300	5317	1227
0.250	2207	293	0.500	4234	608	0.750	6141	968	1.000	7988	1364
0.488	1416	446	0.975	2194	820	1.463	2546	1124	1.950	2685	1356
0.400	1854	383	0.800	3238	718	1.200	4309	1005	1.600	5223	1244
0.525	2251	378	1.050	3691	699	1.575	4592	965	2.100	5223	1206
0.388	2357	274	0.775	4308	605	1.163	5986	1001	1.550	7530	1460
0.400	2593	327	0.800	4715	617	1.200	6523	923	1.600	8174	1360
0.375	2573	348	0.750	4724	659	1.125	6595	933	1.500	8325	1267
0.575	2196	478	1.150	3418	880	1.725	3992	1207	2.300	4241	1457
0.413	2620	349	0.825	4741	658	1.238	6529	928	1.650	8150	1220
0.625	2338	375	1.250	3661	690	1.875	4308	945	2.500	4617	1139
0.550	3141	385	1.100	5374	719	1.650	7003	1001	2.200	8330	1232
0.650	2778	491	1.300	4303	904	1.950	4994	1238	2.600	5268	1494
0.500	2810	371	1.000	4907	695	1.500	6529	973	2.000	7914	1205
0.700	3571	392	1.400	5760	724	2.100	7028	997	2.800	7835	1210
0.738	3590	501	1.475	5549	922	2.213	6420	1263	2.950	6748	1524
0.800	4109	470	1.600	6393	865	2.400	7460	1186	3.200	7920	1433

9.4 Dimension Tables for Heat Resistant SCHNORR Disc Springs

Article No.	Ordering Dimensions						Weight/ 1000 pcs. [kg]	Stress σ_{OM} at $s = h_0$ [N/mm ²]
	D_o [mm]	D_i [mm]	t [mm]	l_0 [mm]	h_0 [mm]	h_0/t		
024 670	6	3.2	0.3	0.4	0.10	0.33	0.046	-1098
025 600	8	3.2	0.3	0.55	0.25	0.83	0.096	-1351
025 800	8	3.2	0.4	0.55	0.15	0.38	0.128	-1081
027 000	8	4.2	0.3	0.5	0.20	0.67	0.083	-1221
027 300	8	4.2	0.4	0.55	0.15	0.38	0.110	-1221
028 900	10	3.2	0.3	0.65	0.35	1.17	0.161	-1164
029 100	10	3.2	0.4	0.7	0.30	0.75	0.214	-1330
029 300	10	3.2	0.5	0.7	0.20	0.40	0.268	-1108
029 600	10	4.2	0.4	0.65	0.25	0.63	0.196	-1170
029 700	10	4.2	0.5	0.7	0.20	0.40	0.245	-1170
030 700	10	5.2	0.4	0.65	0.25	0.63	0.174	-1295
030 900	10	5.2	0.5	0.7	0.20	0.40	0.217	-1295
032 200	12	4.2	0.4	0.8	0.40	1.00	0.301	-1245
032 400	12	4.2	0.5	0.8	0.30	0.60	0.376	-1168
032 702	12	4.2	0.6	0.85	0.25	0.42	0.452	-1168
033 300	12	5.2	0.5	0.8	0.30	0.60	0.348	-1232
033 450	12	5.2	0.6	0.85	0.25	0.42	0.418	-1232
034 100	12	6.2	0.5	0.8	0.30	0.60	0.315	-1343
034 500	12	6.2	0.6	0.85	0.25	0.42	0.378	-1343
035 041	12.5	5.2	0.5	0.85	0.35	0.70	0.385	-1306
035 300	12.5	6.2	0.5	0.8	0.30	0.60	0.351	-1207
035 600	12.5	6.2	0.7	0.95	0.25	0.36	0.492	-1409
038 500	14	7.2	0.5	0.9	0.40	0.80	0.431	-1312
039 000	14	7.2	0.8	1.05	0.25	0.31	0.688	-1312
039 475	15	5.2	0.4	0.95	0.55	1.38	0.473	-1094
039 700	15	5.2	0.5	1	0.50	1.00	0.592	-1244
039 970	15	5.2	0.6	1.05	0.45	0.75	0.710	-1343
040 100	15	5.2	0.7	1.05	0.35	0.50	0.828	-1219
040 949	15	6.2	0.5	1	0.50	1.00	0.558	-1293
041 300	15	6.2	0.6	1	0.40	0.67	0.669	-1242
041 600	15	6.2	0.7	1.05	0.35	0.50	0.781	-1268
042 300	15	8.2	0.7	1	0.30	0.43	0.660	-1252
042 600	15	8.2	0.8	1.05	0.25	0.31	0.754	-1193
043 749	16	8.2	0.4	0.95	0.55	1.38	0.452	-1102
043 900	16	8.2	0.6	1.05	0.45	0.75	0.678	-1353

∅ 6 – 16 mm Material: 1.4122 (X 39 CrMo 17-1)

Deflection s, Load F and Stress σ

at $s = 0.25 h_0$			$s = 0.50 h_0$			$s \approx 0.75 h_0$			$s = 1.00 h_0$		
s	F	σ	s	F	σ	s	F	σ	s	F_c	σ
[mm]	[N]	[N/mm ²]	[mm]	[N]	[N/mm ²]	[mm]	[N]	[N/mm ²]	[mm]	[N]	[N/mm ²]
0.025	28	282	0.050	54	593	0.080	84	932	0.100	103	1300
0.063	46	407	0.125	80	761	0.190	107	1061	0.250	127	1429
0.038	49	319	0.075	95	673	0.110	136	1063	0.150	181	1488
0.050	37	370	0.100	67	699	0.150	92	987	0.200	115	1233
0.038	56	307	0.075	108	642	0.110	154	1017	0.150	205	1428
0.088	52	384	0.175	83	707	0.260	99	971	0.350	110	1175
0.075	76	353	0.150	135	672	0.230	185	1150	0.300	223	1723
0.050	80	369	0.100	154	781	0.150	223	1235	0.200	290	1730
0.063	62	318	0.125	112	601	0.190	158	929	0.250	196	1364
0.050	85	326	0.100	162	692	0.150	235	1097	0.200	306	1543
0.063	68	382	0.125	124	722	0.190	174	1021	0.250	217	1318
0.050	94	330	0.100	180	669	0.150	261	1065	0.200	339	1501
0.100	86	390	0.200	143	724	0.300	181	1002	0.400	209	1291
0.075	94	292	0.150	173	648	0.230	246	1068	0.300	306	1552
0.063	123	360	0.125	234	765	0.190	343	1215	0.250	440	1709
0.075	100	333	0.150	183	631	0.230	260	978	0.300	322	1428
0.063	129	330	0.125	247	704	0.190	362	1120	0.250	464	1580
0.075	109	389	0.150	200	737	0.230	283	1044	0.300	352	1394
0.063	141	345	0.125	270	686	0.190	395	1096	0.250	506	1549
0.088	113	370	0.175	202	696	0.260	274	981	0.350	342	1465
0.075	98	344	0.150	179	652	0.230	255	923	0.300	316	1286
0.063	196	369	0.125	379	779	0.190	560	1229	0.250	723	1719
0.100	122	426	0.200	213	798	0.300	283	1117	0.400	343	1383
0.063	234	352	0.125	456	737	0.190	678	1154	0.250	879	1604
0.138	103	407	0.275	157	746	0.410	178	1017	0.550	183	1219
0.125	135	389	0.250	224	721	0.380	284	997	0.500	326	1298
0.113	173	367	0.225	307	688	0.340	415	1098	0.450	506	1649
0.088	182	346	0.175	342	748	0.260	483	1206	0.350	625	1720
0.125	140	430	0.250	233	798	0.380	296	1105	0.500	339	1351
0.100	151	344	0.200	273	648	0.300	375	963	0.400	468	1426
0.088	189	319	0.175	356	692	0.260	503	1119	0.350	650	1601
0.075	180	332	0.150	343	636	0.230	506	979	0.300	643	1388
0.063	213	309	0.125	414	646	0.190	616	1012	0.250	799	1407
0.138	103	469	0.275	158	862	0.410	179	1178	0.550	185	1417
0.113	175	426	0.225	309	801	0.340	418	1125	0.450	510	1397

∅ 16 – 23 mm Material: 1.4122 (X 39 CrMo 17-1)

Article No.	Ordering Dimensions						Weight/ 1000 pcs. [kg]	Stress σ_{OM} at $s = h_0$ [N/mm ²]
	D_e [mm]	D_i [mm]	t [mm]	l_0 [mm]	h_0 [mm]	h_0/t		
044 102	16	8.2	0.7	1.05	0.35	0.50	0.790	-1227
044 202	16	8.2	0.8	1.1	0.30	0.38	0.903	-1202
044 300	16	8.2	0.9	1.2	0.30	0.33	1.015	-1353
045 700	18	6.2	0.4	1	0.60	1.50	0.685	-828
046 000	18	6.2	0.5	1.1	0.60	1.20	0.856	-1035
046 250	18	6.2	0.6	1.2	0.60	1.00	1.026	-1242
046 300	18	6.2	0.7	1.25	0.55	0.79	1.197	-1329
046 500	18	6.2	0.8	1.25	0.45	0.56	1.368	-1242
046 925	18	8.2	0.5	1.1	0.60	1.20	0.769	-1117
047 100	18	8.2	0.7	1.2	0.50	0.71	1.076	-1303
047 400	18	8.2	0.8	1.25	0.45	0.56	1.230	-1340
047 690	18	8.2	1	1.35	0.35	0.35	1.536	-1303
048 000	18	9.2	0.7	1.15	0.45	0.64	1.003	-1245
048 100	18	9.2	1	1.3	0.30	0.30	1.432	-1185
050 980	20	8.2	0.6	1.3	0.70	1.17	1.195	-1219
051 250	20	8.2	0.7	1.35	0.65	0.93	1.394	-1321
051 400	20	8.2	0.8	1.35	0.55	0.69	1.593	-1277
051 700	20	8.2	0.9	1.4	0.50	0.56	1.791	-1306
051 760	20	8.2	1	1.45	0.45	0.45	1.990	-1306
052 741	20	10.2	0.5	1.1	0.60	1.20	0.887	-959
053 400	20	10.2	0.8	1.3	0.50	0.63	1.417	-1279
053 700	20	10.2	0.9	1.35	0.45	0.50	1.594	-1295
053 900	20	10.2	1	1.4	0.40	0.40	1.771	-1279
054 375	20	10.2	1.1	1.45	0.35	0.32	1.947	-1231
055 300	20	10.2	1.25	1.55	0.30	0.24	2.212	-1199
055 640	20	10.2	1.5	1.75	0.25	0.17	2.652	-1199
057 709	22.5	11.2	0.6	1.4	0.80	1.33	1.370	-1195
057 900	22.5	11.2	0.8	1.45	0.65	0.81	1.826	-1294
058 000	22.5	11.2	1.25	1.65	0.40	0.32	2.850	-1245
059 100	23	8.2	0.7	1.5	0.80	1.14	1.937	-1190
059 200	23	8.2	0.8	1.55	0.75	0.94	2.213	-1275
059 360	23	8.2	0.9	1.6	0.70	0.78	2.490	-1339
059 503	23	8.2	1	1.6	0.60	0.60	2.766	-1275
060 430	23	10.2	0.9	1.55	0.65	0.72	2.292	-1319
060 500	23	10.2	1	1.6	0.60	0.60	2.547	-1353

Deflection s, Load F and Stress σ

at $s = 0.25 h_0$			$s = 0.50 h_0$			$s \approx 0.75 h_0$			$s = 1.00 h_0$		
s [mm]	F [N]	σ [N/mm ²]	s [mm]	F [N]	σ [N/mm ²]	s [mm]	F [N]	σ [N/mm ²]	s [mm]	F _c [N]	σ [N/mm ²]
0.088	183	333	0.175	344	634	0.260	487	946	0.350	630	1358
0.075	220	303	0.150	424	641	0.230	630	1016	0.300	806	1426
0.075	308	356	0.150	598	748	0.230	894	1176	0.300	1147	1639
0.150	86	324	0.300	128	591	0.450	141	803	0.600	139	958
0.150	132	356	0.300	209	655	0.450	249	898	0.600	271	1086
0.150	194	387	0.300	322	719	0.450	406	994	0.600	468	1303
0.138	240	369	0.275	420	691	0.410	558	1058	0.550	682	1603
0.113	251	329	0.225	466	723	0.340	659	1181	0.450	833	1703
0.150	142	423	0.300	225	780	0.450	269	1071	0.600	292	1297
0.125	223	385	0.250	398	724	0.380	547	1018	0.500	668	1365
0.113	271	361	0.225	502	685	0.340	711	1060	0.450	898	1538
0.088	368	363	0.175	713	764	0.260	1034	1202	0.350	1364	1679
0.113	203	368	0.225	369	696	0.340	513	984	0.450	639	1267
0.075	329	324	0.150	642	676	0.230	964	1056	0.300	1241	1464
0.175	218	438	0.350	347	808	0.530	420	1111	0.700	460	1347
0.163	265	422	0.325	448	786	0.490	579	1092	0.650	678	1339
0.138	280	357	0.275	504	673	0.410	686	979	0.550	856	1457
0.125	333	337	0.250	618	679	0.380	881	1113	0.500	1108	1609
0.113	387	350	0.225	736	751	0.340	1065	1202	0.450	1368	1704
0.150	122	378	0.300	193	698	0.450	231	960	0.600	251	1163
0.125	269	374	0.250	491	708	0.380	689	1001	0.500	857	1318
0.113	320	350	0.225	601	667	0.340	861	1001	0.450	1098	1437
0.100	370	323	0.200	710	669	0.300	1029	1064	0.400	1339	1500
0.088	416	330	0.175	809	692	0.260	1177	1084	0.350	1559	1508
0.075	509	348	0.150	1002	718	0.230	1516	1112	0.300	1961	1528
0.063	719	372	0.125	1427	760	0.190	2155	1164	0.250	2824	1584
0.200	244	495	0.400	375	910	0.600	432	1245	0.800	450	1500
0.163	311	418	0.325	541	783	0.490	720	1095	0.650	868	1354
0.100	543	339	0.200	1057	709	0.300	1552	1111	0.400	2037	1545
0.200	284	403	0.400	455	743	0.600	552	1022	0.800	611	1239
0.188	337	390	0.375	568	725	0.560	727	1005	0.750	855	1362
0.175	397	375	0.350	697	703	0.530	938	1047	0.700	1136	1586
0.150	413	321	0.300	758	699	0.450	1058	1152	0.600	1335	1675
0.163	375	387	0.325	669	729	0.490	911	1024	0.650	1119	1399
0.150	438	369	0.300	804	699	0.450	1122	1057	0.600	1417	1546

∅ 23 – 34 mm Material: 1.4122 (X 39 CrMo 17-1)

Article No.	Ordering Dimensions						Weight/ 1000 pcs. [kg]	Stress σ_{OM} at $s = h_0$ [N/mm ²]
	D_e [mm]	D_i [mm]	t [mm]	l_0 [mm]	h_0 [mm]	h_0/t		
060 900	23	10.2	1.25	1.7	0.45	0.36	3.181	-1268
061 570	23	12.2	1	1.5	0.50	0.50	2.277	-1240
061 800	23	12.2	1.25	1.65	0.40	0.32	2.845	-1240
061 950	23	12.2	1.5	1.85	0.35	0.23	3.412	-1302
063 871	25	10.2	1	1.7	0.70	0.70	3.124	-1299
064 399	25	12.2	0.7	1.6	0.90	1.29	2.000	-1256
064 800	25	12.2	0.9	1.6	0.70	0.78	2.570	-1256
065 100	25	12.2	1	1.65	0.65	0.65	2.855	-1296
065 134	25	12.2	1.25	1.75	0.50	0.40	3.567	-1246
065 300	25	12.2	1.5	1.95	0.45	0.30	4.278	-1346
071 500	28	10.2	0.8	1.75	0.95	1.19	3.266	-1094
071 750	28	10.2	1	1.9	0.90	0.90	4.081	-1296
072 000	28	10.2	1.25	1.95	0.70	0.56	5.100	-1260
072 102	28	10.2	1.5	2.1	0.60	0.40	6.118	-1296
072 700	28	12.2	1	1.85	0.85	0.85	3.812	-1285
072 850	28	12.2	1.25	1.95	0.70	0.56	4.763	-1322
073 200	28	12.2	1.5	2.05	0.55	0.37	5.714	-1247
075 250	28	14.2	0.8	1.8	1.00	1.25	2.797	-1300
075 600	28	14.2	1	1.8	0.80	0.80	3.495	-1300
075 920	28	14.2	1.25	1.9	0.65	0.52	4.367	-1320
076 100	28	14.2	1.5	2.05	0.55	0.37	5.237	-1341
082 252	31.5	12.2	1	2.1	1.10	1.10	5.059	-1268
081 502	31.5	12.2	1.25	2.15	0.90	0.72	6.322	-1297
081 516	31.5	12.2	1.5	2.25	0.75	0.50	7.584	-1297
082 800	31.5	16.3	0.8	1.85	1.05	1.31	3.486	-1092
083 400	31.5	16.3	1.25	2.05	0.80	0.64	5.443	-1300
083 700	31.5	16.3	1.5	2.15	0.65	0.43	6.529	-1268
084 200	31.5	16.3	1.75	2.3	0.55	0.31	7.614	-1252
084 850	31.5	16.3	2	2.5	0.50	0.25	8.697	-1300
087 800	34	12.3	1	2.25	1.25	1.25	6.031	-1219
088 045	34	12.3	1.25	2.35	1.10	0.88	7.536	-1341
088 200	34	12.3	1.5	2.4	0.90	0.60	9.040	-1316
089 320	34	14.3	1.25	2.3	1.05	0.84	7.136	-1329
089 370	34	14.3	1.5	2.35	0.85	0.57	8.560	-1291
090 400	34	16.3	1.5	2.3	0.80	0.53	8.008	-1282

Deflection s, Load F and Stress σ

at $s = 0.25 h_0$			$s = 0.50 h_0$			$s \approx 0.75 h_0$			$s = 1.00 h_0$		
s	F	σ	s	F	σ	s	F	σ	s	F _c	σ
[mm]	[N]	[N/mm ²]	[mm]	[N]	[N/mm ²]	[mm]	[N]	[N/mm ²]	[mm]	[N]	[N/mm ²]
0.113	563	356	0.225	1088	750	0.340	1599	1182	0.450	2075	1652
0.125	378	341	0.250	710	650	0.380	1024	935	0.500	1299	1344
0.100	541	324	0.200	1054	680	0.300	1546	1066	0.400	2029	1484
0.088	794	371	0.175	1565	767	0.260	2299	1186	0.350	3068	1628
0.175	449	365	0.350	805	687	0.530	1106	988	0.700	1360	1475
0.225	336	506	0.450	522	932	0.680	610	1277	0.900	645	1541
0.175	372	395	0.350	654	741	0.530	881	1038	0.700	1066	1287
0.163	433	378	0.325	786	715	0.490	1090	1009	0.650	1358	1353
0.125	563	315	0.250	1081	670	0.380	1587	1066	0.500	2040	1501
0.113	840	378	0.225	1639	789	0.340	2429	1232	0.450	3172	1708
0.238	353	381	0.475	561	702	0.710	670	963	0.950	733	1165
0.225	520	391	0.450	885	729	0.680	1152	1013	0.900	1357	1398
0.175	621	322	0.350	1152	707	0.530	1635	1156	0.700	2061	1668
0.150	843	396	0.300	1618	839	0.450	2347	1329	0.600	3053	1865
0.213	496	403	0.425	855	752	0.640	1126	1050	0.850	1345	1294
0.175	652	350	0.350	1209	664	0.530	1716	1079	0.700	2164	1563
0.138	799	351	0.275	1543	741	0.410	2237	1169	0.550	2938	1636
0.250	441	523	0.500	691	964	0.750	813	1323	1.000	871	1600
0.200	483	420	0.400	844	787	0.600	1123	1102	0.800	1362	1364
0.163	636	361	0.325	1190	687	0.490	1696	1009	0.650	2161	1454
0.138	859	343	0.275	1659	725	0.410	2406	1147	0.550	3159	1607
0.275	595	432	0.550	965	800	0.830	1187	1102	1.100	1328	1339
0.225	711	362	0.450	1267	680	0.680	1729	1006	0.900	2122	1505
0.188	889	341	0.375	1671	739	0.560	2372	1194	0.750	3055	1706
0.263	390	455	0.525	603	837	0.790	697	1146	1.050	732	1382
0.200	675	386	0.400	1227	730	0.600	1698	1031	0.800	2128	1316
0.163	839	330	0.325	1599	637	0.490	2317	1021	0.650	2988	1448
0.138	1069	334	0.275	2081	700	0.410	3040	1096	0.550	4014	1524
0.125	1418	370	0.250	2788	767	0.380	4178	1188	0.500	5447	1636
0.313	646	435	0.625	1012	801	0.940	1192	1097	1.250	1276	1323
0.275	827	399	0.550	1416	745	0.830	1851	1036	1.100	2194	1473
0.225	959	333	0.450	1760	714	0.680	2472	1178	0.900	3102	1713
0.263	795	409	0.525	1375	764	0.790	1814	1067	1.050	2174	1353
0.213	921	338	0.425	1704	653	0.640	2404	1072	0.850	3042	1555
0.200	896	346	0.400	1671	657	0.600	2366	1004	0.800	3021	1450

∅ 34 – 56 mm Material: 1.4122 (X 39 CrMo 17-1)

Article No.	Ordering Dimensions						Weight/ 1000 pcs. [kg]	Stress σ_{OM} at $s = h_0$ [N/mm ²]
	D_e [mm]	D_i [mm]	t [mm]	l_0 [mm]	h_0 [mm]	h_0/t		
091 000	34	16.3	2	2.6	0.60	0.30	10.669	-1282
093 705	35.5	18.3	0.9	2.05	1.15	1.28	5.002	-1057
094 100	35.5	18.3	1.25	2.25	1.00	0.80	6.944	-1277
094 400	35.5	18.3	2	2.65	0.65	0.33	11.097	-1328
099 440	40	14.3	1.25	2.65	1.40	1.12	10.480	-1230
099 460	40	14.3	1.5	2.75	1.25	0.83	12.572	-1318
099 829	40	14.3	2	2.9	0.90	0.45	16.754	-1265
100 500	40	16.3	1.5	2.7	1.20	0.80	12.019	-1304
100 800	40	16.3	2	2.9	0.90	0.45	16.017	-1304
101 750	40	18.3	2	2.85	0.85	0.43	15.190	-1284
102 530	40	20.4	1	2.3	1.30	1.30	7.115	-1039
102 900	40	20.4	1.5	2.6	1.10	0.73	10.665	-1319
103 227	40	20.4	2	2.8	0.80	0.40	14.211	-1279
104 200	40	20.4	2.25	2.95	0.70	0.31	15.981	-1259
104 700	40	20.4	2.5	3.15	0.65	0.26	17.751	-1299
110 411	45	22.4	1.25	2.85	1.60	1.28	11.448	-1245
110 500	45	22.4	1.75	2.95	1.20	0.69	16.018	-1307
110 900	45	22.4	2.5	3.35	0.85	0.34	22.863	-1322
115 977	50	18.4	1.25	2.85	1.60	1.28	16.257	-905
116 200	50	18.4	1.5	3.3	1.80	1.20	19.504	-1221
116 650	50	18.4	2	3.45	1.45	0.73	25.994	-1312
116 902	50	18.4	2.5	3.65	1.15	0.46	32.479	-1301
117 200	50	18.4	3	3.95	0.95	0.32	38.958	-1289
117 395	50	20.4	2	3.4	1.40	0.70	25.059	-1299
117 600	50	20.4	2.5	3.6	1.10	0.44	31.310	-1276
118 400	50	22.4	2	3.3	1.30	0.65	24.028	-1246
118 500	50	22.4	2.5	3.6	1.10	0.44	30.020	-1317
119 860	50	25.4	1.25	2.85	1.60	1.28	13.948	-1020
120 102	50	25.4	1.5	3.1	1.60	1.07	16.733	-1224
120 300	50	25.4	2	3.3	1.30	0.65	22.299	-1326
120 800	50	25.4	2.5	3.5	1.00	0.40	27.859	-1275
121 000	50	25.4	3	3.85	0.85	0.28	33.412	-1301
128 420	56	28.5	1.5	3.45	1.95	1.30	20.951	-1191
128 500	56	28.5	2	3.6	1.60	0.80	27.921	-1303
129 050	56	28.5	3	4.05	1.05	0.35	41.840	-1283

Deflection s, Load F and Stress σ

at $s = 0.25 h_0$			$s = 0.50 h_0$			$s \approx 0.75 h_0$			$s = 1.00 h_0$		
s	F	σ	s	F	σ	s	F	σ	s	F_c	σ
[mm]	[N]	[N/mm ²]	[mm]	[N]	[N/mm ²]	[mm]	[N]	[N/mm ²]	[mm]	[N]	[N/mm ²]
0.150	1422	364	0.300	2776	760	0.450	4084	1186	0.600	5370	1644
0.288	464	433	0.575	723	797	0.860	843	1093	1.150	897	1321
0.250	742	415	0.500	1295	778	0.750	1723	1089	1.000	2089	1348
0.163	1487	352	0.325	2891	737	0.490	4261	1157	0.650	5562	1611
0.350	918	412	0.700	1480	761	1.050	1806	1048	1.400	2013	1271
0.313	1130	381	0.625	1957	712	0.940	2587	993	1.250	3106	1505
0.225	1501	372	0.450	2852	795	0.680	4128	1270	0.900	5301	1797
0.300	1091	388	0.600	1905	727	0.900	2535	1016	1.200	3073	1392
0.225	1547	351	0.450	2939	752	0.680	4254	1204	0.900	5462	1707
0.213	1504	329	0.425	2871	703	0.640	4161	1122	0.850	5377	1586
0.325	574	428	0.650	889	788	0.980	1033	1079	1.300	1088	1302
0.275	1051	411	0.550	1867	773	0.830	2537	1086	1.100	3107	1351
0.200	1479	323	0.400	2838	669	0.600	4117	1064	0.800	5356	1500
0.175	1774	340	0.350	3457	712	0.530	5126	1114	0.700	6672	1548
0.163	2219	370	0.325	4357	766	0.490	6473	1189	0.650	8499	1639
0.400	1057	504	0.800	1644	928	1.200	1918	1272	1.600	2037	1536
0.300	1371	393	0.600	2465	740	0.900	3374	1043	1.200	4191	1317
0.213	2328	352	0.425	4515	741	0.640	6633	1165	0.850	8656	1625
0.400	768	329	0.800	1195	606	1.200	1395	828	1.600	1480	998
0.450	1399	429	0.900	2216	791	1.350	2644	1085	1.800	2878	1311
0.363	1848	360	0.725	3289	677	1.090	4467	1050	1.450	5495	1571
0.288	2424	371	0.575	4594	795	0.860	6578	1273	1.150	8512	1805
0.238	3238	425	0.475	6304	888	0.710	9225	1386	0.950	12151	1922
0.350	1797	365	0.700	3220	687	1.050	4392	988	1.400	5440	1475
0.275	2352	347	0.550	4477	742	0.830	6485	1185	1.100	8348	1677
0.325	1666	352	0.650	3022	664	0.980	4188	938	1.300	5217	1372
0.275	2429	337	0.550	4624	721	0.830	6699	1154	1.100	8622	1636
0.400	866	416	0.800	1348	766	1.200	1573	1051	1.600	1670	1269
0.400	1260	453	0.800	2058	840	1.200	2548	1162	1.600	2885	1417
0.325	1774	393	0.650	3218	743	0.980	4460	1049	1.300	5556	1349
0.250	2306	322	0.500	4424	669	0.750	6418	1064	1.000	8348	1500
0.213	3227	363	0.425	6315	755	0.640	9346	1176	0.850	12261	1626
0.488	1480	490	0.975	2292	902	1.460	2659	1236	1.950	2806	1492
0.400	1938	421	0.800	3384	790	1.200	4503	1105	1.600	5458	1369
0.263	3265	333	0.525	6322	703	0.790	9267	1107	1.050	12088	1547

∅ 60 – 100 mm Material: 1.4122 (X 39 CrMo 17-1)

Article No.	Ordering Dimensions						Weight/ 1000 pcs. [kg]	Stress σ_{OM} at $s = h_0$ [N/mm ²]
	D_e [mm]	D_i [mm]	t [mm]	l_0 [mm]	h_0 [mm]	h_0/t		
131 000	60	20.5	2	4.1	2.10	1.05	38.242	-1303
131 298	60	20.5	2.5	4.2	1.70	0.68	47.786	-1319
131 410	60	20.5	3	4.4	1.40	0.47	57.324	-1303
131 800	60	25.5	2.5	4.1	1.60	0.64	44.320	-1305
132 100	60	25.5	3	4.3	1.30	0.43	53.163	-1272
133 192	60	30.5	2.5	4	1.50	0.60	40.115	-1329
133 500	60	30.5	3	4.2	1.20	0.40	48.117	-1276
133 750	60	30.5	3.5	4.55	1.05	0.30	56.110	-1303
138 220	63	31	1.8	4.1	2.30	1.28	32.573	-1306
138 500	63	31	2.5	4.15	1.65	0.66	45.214	-1301
138 720	63	31	3	4.4	1.40	0.47	54.234	-1325
139 000	63	31	3.5	4.7	1.20	0.34	63.247	-1325
144 400	70	25.5	2	4.5	2.50	1.25	51.150	-1152
146 300	70	30.5	2.5	4.7	2.20	0.88	59.715	-1330
146 598	70	30.5	3	4.8	1.80	0.60	71.633	-1306
147 700	70	35.5	3	4.7	1.70	0.57	65.661	-1326
147 980	70	35.5	4	5.2	1.20	0.30	87.480	-1248
150 800	70	40.5	4	5.1	1.10	0.28	78.305	-1265
151 100	70	40.5	5	5.9	0.90	0.18	97.792	-1293
153 010	71	36	2	4.6	2.60	1.30	45.078	-1314
153 100	71	36	2.5	4.5	2.00	0.80	56.326	-1264
153 240	71	36	4	5.3	1.30	0.33	90.018	-1314
159 400	80	31	2.5	5.3	2.80	1.12	81.874	-1251
159 606	80	31	3	5.4	2.40	0.80	98.222	-1287
160 100	80	31	4	5.8	1.80	0.45	130.891	-1287
160 640	80	36	3	5.3	2.30	0.77	92.159	-1294
160 685	80	36	4	5.7	1.70	0.43	122.804	-1275
161 212	80	41	2.25	5	2.75	1.22	63.925	-1240
161 500	80	41	3	5.2	2.20	0.73	85.190	-1323
161 700	80	41	4	5.6	1.60	0.40	113.508	-1282
162 000	80	41	5	6.3	1.30	0.26	141.787	-1303
169 300	90	46	2.5	5.7	3.20	1.28	90.032	-1264
169 500	90	46	3.5	5.8	2.30	0.66	125.968	-1272
169 645	90	46	5	6.6	1.60	0.32	179.789	-1264
174 700	100	41	4	6.8	2.80	0.70	200.275	-1301

Deflection s, Load F and Stress σ

at $s = 0.25 h_0$			$s = 0.50 h_0$			$s \approx 0.75 h_0$			$s = 1.00 h_0$		
s	F	σ	s	F	σ	s	F	σ	s	F _c	σ
[mm]	[N]	[N/mm ²]	[mm]	[N]	[N/mm ²]	[mm]	[N]	[N/mm ²]	[mm]	[N]	[N/mm ²]
0.525	2352	415	1.050	3857	769	1.580	4806	1061	2.100	5458	1326
0.425	2812	343	0.850	5063	686	1.280	6961	1153	1.700	8630	1703
0.350	3509	388	0.700	6642	832	1.050	9524	1332	1.400	12281	1888
0.400	2709	359	0.800	4927	679	1.200	6816	1016	1.600	8541	1496
0.325	3367	339	0.650	6418	725	0.980	9301	1158	1.300	11992	1637
0.375	2689	382	0.750	4937	725	1.130	6916	1026	1.500	8699	1394
0.300	3322	322	0.600	6374	669	0.900	9245	1064	1.200	12026	1500
0.263	4424	357	0.525	8637	745	0.790	12747	1164	1.050	16710	1614
0.575	2295	526	1.150	3572	969	1.730	4175	1328	2.300	4431	1603
0.413	2738	383	0.825	4954	724	1.240	6833	1021	1.650	8517	1342
0.350	3568	345	0.700	6754	666	1.050	9684	1074	1.400	12488	1531
0.300	4577	354	0.600	8873	745	0.900	12982	1173	1.200	16997	1637
0.625	2443	412	1.250	3826	759	1.880	4505	1039	2.500	4824	1253
0.550	3282	424	1.100	5616	791	1.650	7318	1101	2.200	8705	1355
0.450	3804	354	0.900	6984	670	1.350	9749	1033	1.800	12307	1509
0.425	3783	373	0.850	7002	709	1.280	9876	1006	1.700	12499	1421
0.300	5537	343	0.600	10809	715	0.900	15905	1117	1.200	20913	1549
0.275	5560	329	0.550	10894	684	0.830	16172	1065	1.100	21187	1473
0.225	8644	369	0.450	17134	755	0.680	25707	1159	0.900	33858	1581
0.650	2903	540	1.300	4497	994	1.950	5219	1362	2.600	5505	1644
0.500	2936	408	1.000	5128	765	1.500	6823	1070	2.000	8271	1325
0.325	5886	352	0.650	11446	737	0.980	16868	1157	1.300	22020	1610
0.700	3732	431	1.400	6020	796	2.100	7344	1097	2.800	8188	1331
0.600	4305	376	1.200	7519	704	1.800	10005	984	2.400	12127	1421
0.450	6106	358	0.900	11598	767	1.350	16681	1227	1.800	21559	1738
0.575	4224	392	1.150	7439	735	1.730	10004	1031	2.300	12192	1321
0.425	5973	330	0.850	11403	706	1.280	16530	1126	1.700	21360	1591
0.688	3254	495	1.375	5128	912	2.060	6078	1254	2.750	6573	1518
0.550	4216	413	1.100	7489	777	1.650	10134	1092	2.200	12465	1357
0.400	5936	325	0.800	11389	669	1.200	16519	1064	1.600	21488	1500
0.325	8903	370	0.650	17482	766	0.980	25972	1189	1.300	34099	1639
0.800	4294	517	1.600	6680	952	2.400	7796	1305	3.200	8276	1576
0.575	5237	380	1.150	9483	717	1.730	13097	1012	2.300	16322	1284
0.400	8832	338	0.800	17188	709	1.200	25225	1111	1.600	33104	1546
0.700	7200	366	1.400	12898	689	2.100	17595	987	2.800	21791	1472

∅ 100 – 200 mm Material: 1.4122 (X 39 CrMo 17-1)

Article No.	Ordering Dimensions						Weight/ 1000 pcs. [kg]	Stress σ_{OM} at $s = h_0$ [N/mm ²]
	D _e [mm]	D _i [mm]	t [mm]	l ₀ [mm]	h ₀ [mm]	h ₀ /t		
174 750	100	41	5	7.2	2.20	0.44	250.230	-1277
175 590	100	51	2.7	6.3	3.60	1.33	120.314	-1243
176 000	100	51	3.5	6.3	2.80	0.80	155.895	-1253
176 275	100	51	4	6.5	2.50	0.63	178.116	-1279
176 500	100	51	5	7	2.00	0.40	222.523	-1279
176 900	100	51	6	7.7	1.70	0.28	266.881	-1304
183 308	112	57	3	6.7	3.70	1.23	167.989	-1130
183 400	112	57	4	7.2	3.20	0.80	223.876	-1303
183 750	112	57	6	8.1	2.10	0.35	335.486	-1283
005 215	125	41	4	8.2	4.20	1.05	335.918	-1195
189 050	125	51	4	8.4	4.40	1.10	313.759	-1306
189 190	125	51	5	8.5	3.50	0.70	392.056	-1299
189 302	125	51	6	9.4	3.40	0.57	470.297	-1514
190 252	125	61	5	8.3	3.30	0.66	358.240	-1316
190 508	125	61	6	8.7	2.70	0.45	429.708	-1292
190 700	125	64	3.5	8	4.50	1.29	243.002	-1292
190 998	125	64	5	8.2	3.20	0.64	346.916	-1312
003 097	125	71	6	8.4	2.40	0.40	381.861	-1276
199 158	140	72	3.8	8.7	4.90	1.29	330.005	-1221
199 400	140	72	5	9	4.00	0.80	434.011	-1312
202 698	150	61	5	10.1	5.10	1.02	565.721	-1313
005 216	150	61	6	10.25	4.25	0.71	678.661	-1313
203 073	150	71	6	10	4.00	0.67	630.814	-1309
001 038	160	82	4.3	9.9	5.60	1.30	489.219	-1206
207 898	160	82	6	10.3	4.30	0.72	682.231	-1292
000 127	180	92	4.8	10.8	6.00	1.25	692.651	-1138
213 742	180	92	6	11.1	5.10	0.85	865.497	-1209
000 489	200	102	5.5	12.5	7.00	1.27	981.059	-1231

Deflection s, Load F and Stress σ

at $s = 0.25 h_0$			$s = 0.50 h_0$			$s \approx 0.75 h_0$			$s = 1.00 h_0$		
s	F	σ	s	F	σ	s	F	σ	s	F _c	σ
[mm]	[N]	[N/mm ²]	[mm]	[N]	[N/mm ²]	[mm]	[N]	[N/mm ²]	[mm]	[N]	[N/mm ²]
0.550	9422	346	1.100	17934	741	1.650	25839	1183	2.200	33441	1675
0.900	5139	519	1.800	7906	955	2.700	9092	1306	3.600	9487	1574
0.700	5706	405	1.400	9966	760	2.100	13261	1064	2.800	16074	1317
0.625	6729	374	1.250	12280	708	1.880	17084	1001	2.500	21422	1318
0.500	9247	323	1.000	17740	669	1.500	25732	1064	2.000	33473	1500
0.425	12939	363	0.850	25322	755	1.280	37476	1176	1.700	49165	1627
0.925	5320	452	1.850	8362	833	2.780	9891	1144	3.700	10649	1385
0.800	7750	421	1.600	13535	790	2.400	18011	1105	3.200	21831	1369
0.525	13060	333	1.050	25287	703	1.580	37068	1107	2.100	48353	1547
1.050	8625	376	2.100	14146	695	3.150	17598	959	4.200	20016	1253
1.100	9815	454	2.200	15907	839	3.300	19516	1157	4.400	21884	1407
0.875	11233	365	1.750	20124	687	2.630	27491	988	3.500	34000	1475
0.850	17275	392	1.700	31973	781	2.550	44952	1283	3.400	57073	1858
0.825	11078	387	1.650	20045	730	2.480	27647	1030	3.300	34460	1365
0.675	13799	332	1.350	26210	664	2.030	37779	1066	2.700	48720	1515
1.125	8638	530	2.250	13423	975	3.380	15646	1337	4.500	16573	1614
0.800	10899	388	1.600	19819	733	2.400	27419	1036	3.200	34360	1337
0.600	13292	337	1.200	25500	647	1.800	36988	995	2.400	48114	1405
1.225	9653	502	2.450	14988	925	3.680	17452	1267	4.900	18464	1530
1.000	12189	426	2.000	21288	798	3.000	28327	1117	4.000	34335	1383
1.275	14460	438	2.550	23891	813	3.830	29989	1125	5.100	34372	1373
1.063	16448	370	2.125	29404	697	3.190	40055	994	4.250	49496	1487
1.000	15936	381	2.000	28787	720	3.000	39583	1015	4.000	49350	1378
1.400	12339	498	2.800	19107	917	4.200	22161	1256	5.600	23358	1516
1.075	16287	400	2.150	29055	753	3.230	39522	1059	4.300	48726	1318
1.500	13903	459	3.000	21773	846	4.500	25621	1161	6.000	27458	1405
1.275	16799	402	2.550	28967	752	3.830	38079	1050	5.100	45584	1297
1.750	20106	501	3.500	31331	923	5.250	36637	1265	7.000	38983	1529

∅ 20 – 50 mm Material: 1.4923 (X 22 CrMoV 12 1)

Article No.	Ordering Dimensions							Weight/ 1000 pcs. [kg]	Stress σ_{OM} at $s = h_0$ [N/mm ²]
	D _e [mm]	D _i [mm]	t [mm]	t' [mm]	l ₀ [mm]	h ₀ [mm]	h ₀ /t		
055 660	20	10.2	1.5		1.75	0.25	0.17	2.652	-1199
061 952	23	12.2	1.5		1.85	0.35	0.23	3.412	-1302
065 500	25	12.2	1.5		1.95	0.45	0.30	4.278	-1346
072 104	28	10.2	1.5		2.05	0.55	0.37	6.118	-1188
073 250	28	12.2	1.5		2.05	0.55	0.37	5.714	-1247
076 300	28	14.2	1.5		2.05	0.55	0.37	5.237	-1341
083 900	31.5	16.3	1.5		2.15	0.65	0.43	6.529	-1268
084 400	31.5	16.3	1.75		2.3	0.55	0.31	7.614	-1252
084 801	31.5	16.3	2		2.5	0.50	0.25	8.697	-1300
088 400	34	12.3	1.5		2.4	0.90	0.60	9.040	-1316
089 500	34	14.3	1.5		2.35	0.85	0.57	8.560	-1291
090 600	34	16.3	1.5		2.3	0.80	0.53	8.008	-1282
091 200	34	16.3	2		2.6	0.60	0.30	10.669	-1282
094 600	35.5	18.3	2		2.65	0.65	0.33	11.097	-1328
099 464	40	14.3	1.5		2.75	1.25	0.83	12.572	-1318
099 860	40	14.3	2		2.9	0.90	0.45	16.754	-1265
100 700	40	16.3	1.5		2.7	1.20	0.80	12.019	-1304
100 734	40	16.3	2		2.9	0.90	0.45	16.017	-1304
101 800	40	18.3	2		2.85	0.85	0.43	15.190	-1284
103 100	40	20.4	1.5		2.6	1.10	0.73	10.665	-1319
103 600	40	20.4	2		2.8	0.80	0.40	14.211	-1279
104 300	40	20.4	2.25		2.95	0.70	0.31	15.981	-1259
104 800	40	20.4	2.5		3.15	0.65	0.26	17.751	-1299
110 600	45	22.4	1.75		2.95	1.20	0.69	16.018	-1307
111 000	45	22.4	2.5		3.35	0.85	0.34	22.863	-1322
116 400	50	18.4	1.5		3.3	1.80	1.20	19.504	-1221
116 654	50	18.4	2		3.3	1.30	0.65	25.994	-1176
116 903	50	18.4	2.5		3.65	1.15	0.46	32.479	-1301
117 204	50	18.4	3		3.95	0.95	0.32	38.958	-1289
117 450	50	20.4	2		3.4	1.40	0.70	25.059	-1299
117 700	50	20.4	2.5		3.6	1.10	0.44	31.310	-1276
118 405	50	22.4	2		3.3	1.30	0.65	24.028	-1246
118 600	50	22.4	2.5		3.6	1.10	0.44	30.020	-1317
120 104	50	25.4	1.5		3.1	1.60	1.07	16.733	-1224
120 500	50	25.4	2		3.3	1.30	0.65	22.299	-1326

Deflection s , Load F and Stress σ

at $s = 0.25 h_0$			$s = 0.50 h_0$			$s \approx 0.75 h_0$			$s = 1.00 h_0$		
s [mm]	F [N]	σ [N/mm ²]	s [mm]	F [N]	σ [N/mm ²]	s [mm]	F [N]	σ [N/mm ²]	s [mm]	F_c [N]	σ [N/mm ²]
0.063	719	372	0.125	1427	760	0.190	2155	1164	0.250	2824	1584
0.088	794	371	0.175	1565	767	0.260	2299	1186	0.350	3068	1628
0.113	840	378	0.225	1639	789	0.340	2429	1232	0.450	3172	1708
0.138	761	376	0.275	1470	791	0.410	2131	1245	0.550	2799	1739
0.138	799	351	0.275	1543	741	0.410	2237	1169	0.550	2938	1636
0.138	859	343	0.275	1659	725	0.410	2406	1147	0.550	3159	1607
0.163	839	330	0.325	1599	637	0.490	2317	1021	0.650	2988	1448
0.138	1069	334	0.275	2081	700	0.410	3040	1096	0.550	4014	1524
0.125	1418	370	0.250	2788	767	0.380	4178	1188	0.500	5447	1636
0.225	959	333	0.450	1760	714	0.680	2472	1178	0.900	3102	1713
0.213	921	338	0.425	1704	653	0.640	2404	1072	0.850	3042	1555
0.200	896	346	0.400	1671	657	0.600	2366	1004	0.800	3021	1450
0.150	1422	364	0.300	2776	760	0.450	4084	1186	0.600	5370	1644
0.163	1487	352	0.325	2891	737	0.490	4261	1157	0.650	5562	1611
0.313	1130	381	0.625	1957	712	0.940	2587	993	1.250	3106	1505
0.225	1501	372	0.450	2852	795	0.680	4128	1270	0.900	5301	1797
0.300	1091	388	0.600	1905	727	0.900	2535	1016	1.200	3073	1392
0.225	1547	351	0.450	2939	752	0.680	4254	1204	0.900	5462	1707
0.213	1504	329	0.425	2871	703	0.640	4161	1122	0.850	5377	1586
0.275	1051	411	0.550	1867	773	0.830	2537	1086	1.100	3107	1351
0.200	1479	323	0.400	2838	669	0.600	4117	1064	0.800	5356	1500
0.175	1774	340	0.350	3457	712	0.530	5126	1114	0.700	6672	1548
0.163	2219	370	0.325	4357	766	0.490	6473	1189	0.650	8499	1639
0.300	1371	393	0.600	2465	740	0.900	3374	1043	1.200	4191	1317
0.213	2328	352	0.425	4515	741	0.640	6633	1165	0.850	8656	1625
0.450	1399	429	0.900	2216	791	1.350	2644	1085	1.800	2878	1311
0.325	1573	309	0.650	2854	599	0.980	3955	1001	1.300	4927	1472
0.288	2424	371	0.575	4594	795	0.860	6578	1273	1.150	8512	1805
0.238	3238	425	0.475	6304	888	0.710	9225	1386	0.950	12151	1922
0.350	1797	365	0.700	3220	687	1.050	4392	988	1.400	5440	1475
0.275	2352	347	0.550	4477	742	0.830	6485	1185	1.100	8348	1677
0.325	1666	352	0.650	3022	664	0.980	4188	938	1.300	5217	1372
0.275	2429	337	0.550	4624	721	0.830	6699	1154	1.100	8622	1636
0.400	1260	453	0.800	2058	840	1.200	2548	1162	1.600	2885	1417
0.325	1774	393	0.650	3218	743	0.980	4460	1049	1.300	5556	1349

∅ 50 – 90 mm Material: 1.4923 (X 22 CrMoV 12 1)

Article No.	Ordering Dimensions							Weight/ 1000 pcs. [kg]	Stress σ_{OM} at $s = h_0$ [N/mm ²]
	D _g [mm]	D _i [mm]	t [mm]	t' [mm]	l ₀ [mm]	h ₀ [mm]	h ₀ /t		
120 900	50	25.4	2.5		3.5	1.00	0.40	27.859	-1275
121 100	50	25.4	3		3.85	0.85	0.28	33.412	-1301
128 598	56	28.5	1.5		3.45	1.95	1.30	20.951	-1191
128 700	56	28.5	2		3.6	1.60	0.80	27.921	-1303
129 100	56	28.5	3		4.05	1.05	0.35	41.840	-1283
131 100	60	20.5	2		4.1	2.10	1.05	38.242	-1303
131 300	60	20.5	2.5		4.2	1.70	0.68	47.786	-1319
131 412	60	20.5	3		4.4	1.40	0.47	57.324	-1303
131 900	60	25.5	2.5		4.1	1.60	0.64	44.320	-1305
132 200	60	25.5	3		4.3	1.30	0.43	53.163	-1272
133 194	60	30.5	2.5		4	1.50	0.60	40.115	-1329
133 600	60	30.5	3		4.2	1.20	0.40	48.117	-1276
133 830	60	30.5	3.5		4.55	1.05	0.30	56.110	-1303
003 085	63	31	1.8		4.1	2.30	1.28	32.573	-1306
138 600	63	31	2.5		4.15	1.65	0.66	45.214	-1301
138 850	63	31	3.5		4.7	1.20	0.34	63.247	-1325
146 400	70	30.5	2.5		4.7	2.20	0.88	59.715	-1330
146 600	70	30.5	3		4.8	1.80	0.60	71.633	-1306
147 800	70	35.5	3		4.7	1.70	0.57	65.661	-1326
148 050	70	35.5	4		5.2	1.20	0.30	87.480	-1248
150 600	70	40.5	4		5.1	1.10	0.28	78.305	-1265
151 200	70	40.5	5		5.9	0.90	0.18	97.792	-1293
153 012	71	36	2		4.6	2.60	1.30	45.078	-1314
153 200	71	36	2.5		4.5	2.00	0.80	56.326	-1264
153 400	71	36	4		5.3	1.30	0.33	90.018	-1314
159 500	80	31	2.5		5.3	2.80	1.12	81.874	-1251
159 660	80	31	3		5.4	2.40	0.80	98.222	-1287
160 650	80	36	3		5.3	2.30	0.77	92.159	-1294
160 660	80	36	4		5.7	1.70	0.43	122.804	-1275
161 230	80	41	2.25		5	2.75	1.22	63.925	-1240
161 475	80	41	3		5.2	2.20	0.73	85.190	-1323
161 800	80	41	4		5.6	1.60	0.40	113.508	-1282
162 100	80	41	5		6.3	1.30	0.26	141.787	-1303
169 400	90	46	2.5		5.7	3.20	1.28	90.032	-1264
169 600	90	46	3.5		5.8	2.30	0.66	125.968	-1272

Deflection s , Load F and Stress σ

at $s = 0.25 h_0$			$s = 0.50 h_0$			$s \approx 0.75 h_0$			$s = 1.00 h_0$		
s [mm]	F [N]	σ [N/mm ²]	s [mm]	F [N]	σ [N/mm ²]	s [mm]	F [N]	σ [N/mm ²]	s [mm]	F_c [N]	σ [N/mm ²]
0.250	2306	322	0.500	4424	669	0.750	6418	1064	1.000	8348	1500
0.213	3227	363	0.425	6315	755	0.640	9346	1176	0.850	12261	1626
0.488	1480	490	0.975	2292	902	1.460	2659	1236	1.950	2806	1492
0.400	1938	421	0.800	3384	790	1.200	4503	1105	1.600	5458	1369
0.263	3265	333	0.525	6322	703	0.790	9267	1107	1.050	12088	1547
0.525	2352	415	1.050	3857	769	1.580	4806	1061	2.100	5458	1326
0.425	2812	343	0.850	5063	686	1.280	6961	1153	1.700	8630	1703
0.350	3509	388	0.700	6642	832	1.050	9524	1332	1.400	12281	1888
0.400	2709	359	0.800	4927	679	1.200	6816	1016	1.600	8541	1496
0.325	3367	339	0.650	6418	725	0.980	9301	1158	1.300	11992	1637
0.375	2689	382	0.750	4937	725	1.130	6916	1026	1.500	8699	1394
0.300	3322	322	0.600	6374	669	0.900	9245	1064	1.200	12026	1500
0.263	4424	357	0.525	8637	745	0.790	12747	1164	1.050	16710	1614
0.575	2295	526	1.150	3572	969	1.730	4175	1328	2.300	4431	1603
0.413	2738	383	0.825	4954	724	1.240	6833	1021	1.650	8517	1342
0.300	4577	354	0.600	8873	745	0.900	12982	1173	1.200	16997	1637
0.550	3282	424	1.100	5616	791	1.650	7318	1101	2.200	8705	1355
0.450	3804	354	0.900	6984	670	1.350	9749	1033	1.800	12307	1509
0.425	3783	373	0.850	7002	709	1.280	9876	1006	1.700	12499	1421
0.300	5537	343	0.600	10809	715	0.900	15905	1117	1.200	20913	1549
0.275	5560	329	0.550	10894	684	0.830	16172	1065	1.100	21187	1473
0.225	8644	369	0.450	17134	755	0.680	25707	1159	0.900	33858	1581
0.650	2903	540	1.300	4497	994	1.950	5219	1362	2.600	5505	1644
0.500	2936	408	1.000	5128	765	1.500	6823	1070	2.000	8271	1325
0.325	5886	352	0.650	11446	737	0.980	16868	1157	1.300	22020	1610
0.700	3732	431	1.400	6020	796	2.100	7344	1097	2.800	8188	1331
0.600	4305	376	1.200	7519	704	1.800	10005	984	2.400	12127	1421
0.575	4224	392	1.150	7439	735	1.730	10004	1031	2.300	12192	1321
0.425	5973	330	0.850	11403	706	1.280	16530	1126	1.700	21360	1591
0.688	3254	495	1.375	5128	912	2.060	6078	1254	2.750	6573	1518
0.550	4216	413	1.100	7489	777	1.650	10134	1092	2.200	12465	1357
0.400	5936	325	0.800	11389	669	1.200	16519	1064	1.600	21488	1500
0.325	8903	370	0.650	17482	766	0.980	25972	1189	1.300	34099	1639
0.800	4294	517	1.600	6680	952	2.400	7796	1305	3.200	8276	1576
0.575	5237	380	1.150	9483	717	1.730	13097	1012	2.300	16322	1284

∅ 90 – 200 mm Material: 1.4923 (X 22 CrMoV 12 1)

Article No.	Ordering Dimensions								Weight/ 1000 pcs. [kg]	Stress σ_{OM} at $s = h_0$ [N/mm ²]
	D _e [mm]	D _i [mm]	t [mm]	t' [mm]	l ₀ [mm]	h ₀ [mm]	h ₀ /t	h ₀ '/t'		
169 800	90	46	5		6.6	1.60	0.32		179.789	-1264
174 704	100	41	4		6.8	2.80	0.70		200.275	-1301
174 752	100	41	5		7.2	2.20	0.44		250.230	-1277
175 591	100	51	2.7		6.3	3.60	1.33		120.314	-1243
176 002	100	51	3.5		6.3	2.80	0.80		155.895	-1253
176 300	100	51	4		6.5	2.50	0.63		178.116	-1279
176 600	100	51	5		7	2.00	0.40		222.523	-1279
177 000	100	51	6		7.7	1.70	0.28		266.881	-1304
183 310	112	57	3		6.7	3.70	1.23		167.989	-1130
183 320	112	57	4		7.2	3.20	0.80		223.876	-1303
183 800	112	57	6		8.1	2.10	0.35		335.486	-1283
188 970	125	41	4		8.2	4.20	1.05		335.918	-1195
189 052	125	51	4		8.4	4.40	1.10		313.759	-1306
189 200	125	51	5		8.5	3.50	0.70		392.056	-1299
190 253	125	61	5		8.3	3.30	0.66		358.240	-1316
190 510	125	61	6		8.7	2.70	0.45		429.708	-1292
001 490	125	61	8	7.5	10	2.00		0.33	536.796	-1301
190 701	125	64	3.5		8	4.50	1.29		243.002	-1292
001 526	125	64	5		8.3	3.30	0.66		346.916	-1353
004 718	125	64	8	7.5	10	2.00		0.33	519.800	-1338
192 600	125	71	6		8.4	2.40	0.40		381.861	-1276
192 904	125	71	8	7.4	9.8	1.80		0.32	470.633	-1306
193 194	125	71	10	9.2	11.5	1.50		0.25	584.586	-1368
199 160	140	72	3.8		8.7	4.90	1.29		330.005	-1221
199 444	140	72	5		9	4.00	0.80		434.011	-1312
202 700	150	61	5		10.1	5.10	1.02		565.721	-1313
203 075	150	71	6		10	4.00	0.67		630.814	-1309
002 858	150	81	8	7.5	10.7	2.70		0.43	719.402	-1295
001 242	160	82	6		10.3	4.30	0.72		682.231	-1292
208 310	160	82	10	9.4	12.6	2.60		0.34	1067.576	-1326
213 744	180	92	6		11.1	5.10	0.85		865.497	-1209
213 937	180	92	10	9.4	13.3	3.30		0.41	1354.537	-1324
000 212	200	82	8	7.6	13.6	5.60		0.79	1523.868	-1300
003 095	200	92	10	9.5	14.3	4.30		0.51	1804.099	-1314
218 909	200	92	12	11.4	15.6	3.60		0.37	2163.894	-1327

Deflection s, Load F and Stress σ

at $s = 0.25 h_0$			$s = 0.50 h_0$			$s \approx 0.75 h_0$			$s = 1.00 h_0$		
s	F	σ	s	F	σ	s	F	σ	s	F	σ
[mm]	[N]	[N/mm ²]	[mm]	[N]	[N/mm ²]	[mm]	[N]	[N/mm ²]	[mm]	[N]	[N/mm ²]
0.400	8832	338	0.800	17188	709	1.200	25225	1111	1.600	33104	1546
0.700	7200	366	1.400	12898	689	2.100	17595	987	2.800	21791	1472
0.550	9422	346	1.100	17934	741	1.650	25839	1183	2.200	33441	1675
0.900	5139	519	1.800	7906	955	2.700	9092	1306	3.600	9487	1574
0.700	5706	405	1.400	9966	760	2.100	13261	1064	2.800	16074	1317
0.625	6729	374	1.250	12280	708	1.880	17084	1001	2.500	21422	1318
0.500	9247	323	1.000	17740	669	1.500	25732	1064	2.000	33473	1500
0.425	12939	363	0.850	25322	755	1.280	37476	1176	1.700	49165	1627
0.925	5320	452	1.850	8362	833	2.780	9891	1144	3.700	10649	1385
0.800	7750	421	1.600	13535	790	2.400	18011	1105	3.200	21831	1369
0.525	13060	333	1.050	25287	703	1.580	37068	1107	2.100	48353	1547
1.050	8625	376	2.100	14146	695	3.150	17598	959	4.200	20016	1253
1.100	9815	454	2.200	15907	839	3.300	19516	1157	4.400	21884	1407
0.875	11233	365	1.750	20124	687	2.630	27491	988	3.500	34000	1475
0.825	11078	387	1.650	20045	730	2.480	27647	1030	3.300	34460	1365
0.675	13799	332	1.350	26210	664	2.030	37779	1066	2.700	48720	1515
0.500	22799	339	1.000	44284	708	1.500	64785	1108	2.000	84629	1538
1.125	8638	530	2.250	13423	975	3.380	15646	1337	4.500	16573	1614
0.825	11391	405	1.650	20611	765	2.480	28428	1079	3.300	35433	1362
0.500	23443	338	1.000	45535	707	1.500	66615	1106	2.000	87019	1536
0.600	13292	337	1.200	25500	647	1.800	36988	995	2.400	48114	1405
0.450	22678	338	0.900	44138	658	1.350	64660	1009	1.800	84525	1399
0.375	35942	353	0.750	70798	725	1.130	105229	1115	1.500	138102	1525
1.225	9635	502	2.450	14988	925	3.680	17452	1267	4.900	18464	1530
1.000	12189	426	2.000	21288	798	3.000	28327	1117	4.000	34335	1383
1.275	14460	438	2.550	23891	813	3.830	29989	1125	5.100	34372	1373
1.000	15936	381	2.000	28787	720	3.000	39583	1015	4.000	49350	1378
0.675	23766	352	1.350	45331	678	2.030	65426	978	2.700	84211	1361
1.075	16287	400	2.150	29055	753	3.230	39522	1059	4.300	48726	1318
0.650	36468	333	1.300	70741	697	1.950	103379	1093	2.600	134941	1520
1.275	16799	402	2.550	28967	752	3.830	38079	1050	5.100	45584	1297
0.825	37743	348	1.650	72166	671	2.480	104347	1030	3.300	134612	1453
1.400	30338	396	2.800	53021	744	4.200	70379	1044	5.600	84741	1305
1.075	39552	351	2.150	74144	672	3.230	105346	1027	4.300	134175	1473
0.900	53428	348	1.800	103089	733	2.700	150010	1154	3.600	195220	1613

∅ 200 – 250 mm Material: 1.4923 (X 22 CrMoV 12 1)

Article No.	Ordering Dimensions								Weight/ 1000 pcs. [kg]	Stress σ_{OM} at $s = h_0$ [N/mm ²]
	D _e [mm]	D _i [mm]	t [mm]	t' [mm]	l ₀ [mm]	h ₀ [mm]	h ₀ /t	h ₀ '/t'		
000 436	200	102	5.5		12.38	6.88	1.25		981.059	-1210
219 400	200	102	8		13.1	5.10	0.64		1426.016	-1304
004 014	200	102	12	11.3	15.4	3.40		0.36	2012.423	-1326
002 226	200	102	14	13.1	16.9	2.90		0.29	2331.832	-1326
003 739	200	112	14	12.9	15.6	1.60		0.21	2129.412	-790
223 110	225	112	8	7.5	14.5	6.50		0.93	1721.243	-1285
001 030	250	127	7	6.7	14.8	7.80		1.21	1873.549	-1101
226 660	250	127	10		16.4	6.40	0.64		2794.326	-1306
003 913	250	127	12	11.25	17.3	5.30		0.54	3142.758	-1311
004 175	250	127	14	13.1	18.55	4.55		0.42	3658.086	-1321
002 618	250	127	16		20	4.00	0.25		4465.057	-1306

Deflection s, Load F and Stress σ

at $s = 0.25 h_0$			$s = 0.50 h_0$			$s \approx 0.75 h_0$			$s = 1.00 h_0$		
s	F	σ	s	F	σ	s	F	σ	s	F	σ
[mm]	[N]	[N/mm ²]	[mm]	[N]	[N/mm ²]	[mm]	[N]	[N/mm ²]	[mm]	[N]	[N/mm ²]
1.720	19415	488	3.440	30399	899	5.160	35762	1234	6.880	38315	1492
1.275	27679	384	2.550	50362	727	3.830	69787	1027	5.100	87404	1334
0.850	53088	335	1.700	102553	685	2.550	149344	1079	3.400	194407	1507
0.725	69822	353	1.450	136621	731	2.180	201549	1134	2.900	264003	1563
0.400	40143	215	0.800	79488	439	1.200	118174	670	1.600	156338	911
1.625	33348	457	3.250	56219	854	4.880	71819	1193	6.500	83197	1472
1.950	27287	444	3.900	43146	822	5.850	51201	1132	7.800	55075	1376
1.600	43384	385	3.200	78891	728	4.800	109145	1028	6.400	136773	1337
1.325	57731	375	2.650	107399	716	3.980	151423	1023	5.300	191591	1333
1.138	73747	348	2.275	140980	670	3.410	203283	1026	4.550	262776	1447
1.000	91125	376	2.000	179173	778	3.000	265169	1206	4.000	350139	1660

9.5 Dimension Tables for SCHNORR “K” Disc Springs

Non-slotted springs

Article No.	Ordering Dimensions				h_0 [mm]	h_0/t	Spring Load F and Deflection s at $s \approx 0.75 h_0$	
	D_e [mm]	D_i [mm]	t [mm]	l_0 [mm]			F [N]	s [mm]
241200	9.8	6.2	0.2	0.4	0.20	1.00	23	0.15
241400	12.8	7.2	0.25	0.5	0.25	1.00	29	0.19
241600	15.8	8.2	0.25	0.55	0.30	1.20	23	0.23
241700	18.8	9.2	0.3	0.65	0.35	1.17	31	0.26
241800	18.8	10.2	0.35	0.7	0.35	1.00	51	0.26
241900	21.8	12.3	0.35	0.75	0.40	1.14	46	0.30
242100	23.7	14.3	0.4	0.9	0.50	1.25	81	0.38
242200	25.7	14.3	0.4	0.90	0.50	1.25	63	0.38
242300	27.7	17.3	0.4	1	0.60	1.50	80	0.45
242500	29.7	17.4	0.4	1.1	0.70	1.75	83	0.53
242600	31.7	20.4	0.4	1.1	0.70	1.75	81	0.53
242800	34.6	20.4	0.4	1.1	0.70	1.75	61	0.53
242900	34.6	22.4	0.5	1.2	0.70	1.40	118	0.53
243000	36.6	20.4	0.5	1.3	0.80	1.60	110	0.60
243100	39.6	25.5	0.5	1.3	0.80	1.60	110	0.60
243200	41.6	25.5	0.5	1.4	0.90	1.80	113	0.68
243300	46.5	30.5	0.6	1.5	0.90	1.50	153	0.68
243400	51.5	35.5	0.6	1.5	0.90	1.50	135	0.68
243500	54.5	40.5	0.6	1.5	0.90	1.50	141	0.68
243600	61.5	40.5	0.7	1.8	1.10	1.57	176	0.83
243700	67.5	50.5	0.7	1.7	1.00	1.43	161	0.75
243800	71.5	45.5	0.7	2.1	1.40	2.00	185	1.05
243900	71.5	50.5	0.7	2.1	1.40	2.00	218	1.05
244000	74.5	55.5	0.8	1.9	1.10	1.38	211	0.83
244100	79.5	50.5	0.8	2.3	1.50	1.88	228	1.13
244200	79.5	55.5	0.8	2.3	1.50	1.88	263	1.13
244300	84.5	60.5	0.9	2.5	1.60	1.78	359	1.20
244400	89.5	60.5	0.9	2.5	1.60	1.78	288	1.20
244500	89.5	65.5	0.9	2.5	1.60	1.78	335	1.20
244600	94.5	75.5	1	2.2	1.20	1.20	325	0.90
244700	99.0	65.5	1	2.6	1.60	1.60	292	1.20
244800	99.0	70.5	1	2.6	1.60	1.60	332	1.20
244900	109.0	70.5	1.25	2.7	1.45	1.16	357	1.09
245000	109.0	75.5	1.25	2.7	1.45	1.16	398	1.09

∅ 9.8 – 109 mm

Weight/ 1000 pcs. [kg]	Ball-Bearing Type			Ball-Bearing Dimension			
				Outer dia.	Inner dia.		
0.068	623(EL3)			10	3	–	–
0.167	624(EL4)			13	4	–	–
0.275	625(EL5) 634(R4)			16	5	4	–
0.487	626(EL6) 635(R5)			16	6	5	–
0.526	607(EL7)			19	7	–	–
0.684	608(EL8) 627(R7)			22	8	7	–
0.862	609(EL9)			24	9	–	–
1.105	6000	629(R9)		26	10	9	–
1.132	6001			28	12	–	–
1.406		6200		30	–	10	–
1.422	6002	6201		32	15	12	–
1.894			6300	35	–	–	10
2.103	6003	6202		35	17	15	–
2.805			6301	37	–	–	12
2.783		6203		40	–	17	–
3.282	6004		6302	42	20	–	15
4.486	6005	6204	6303	47	25	20	17
5.059		6205	6304	52	–	25	20
4.822	6006			55	30	–	–
9.121	6007	6206	6305	62	35	30	25
8.505	6008			68	40	–	–
12.99			6306	72	–	–	30
10.90		6207		72	–	35	–
11.99	6009			75	45	–	–
18.40			6307	80	–	–	35
15.78	6010	6208		80	50	40	–
19.05		6209		85	–	45	–
23.86			6308	90	–	–	40
20.36	6011	6210		90	55	50	–
19.57	6012			95	60	–	–
33.64			6309	100	–	–	45
29.44	6013	6211		100	65	55	–
52.80			6310	110	–	–	50
47.17	6014	6212		110	70	60	–

∅ 114 – 358 mm

Non-slotted springs

Article No.	Ordering Dimensions						Spring Load F and Deflection s at $s \approx 0.75 h_0$	
	D _e [mm]	D _i [mm]	t [mm]	l ₀ [mm]	h ₀ [mm]	h ₀ /t	F [N]	s [mm]
245100	114	90.5	1.25	2.45	1.20	0.96	398	0.90
245200	119	75.5	1.25	2.8	1.55	1.24	320	1.16
245300	119	85.5	1.25	2.8	1.55	1.24	393	1.16
245400	124	90.5	1.25	3	1.75	1.40	445	1.31
245500	129	85.5	1.25	3.2	1.95	1.56	405	1.46
245600	129	95.5	1.25	3.2	1.95	1.56	500	1.46
245700	139	90.5	1.25	3.25	2.00	1.60	354	1.50
245800	139	101	1.25	3.25	2.00	1.60	429	1.50
245900	149	95.5	1.5	3.2	1.70	1.13	379	1.28
246000	149	106	1.5	3.2	1.70	1.13	450	1.28
246100	159	101	1.5	3.5	2.00	1.33	412	1.50
246200	159	111	1.5	3.5	2.00	1.33	477	1.50
246300	169	111	1.5	3.8	2.30	1.53	470	1.73
246400	169	121	1.5	3.8	2.30	1.53	546	1.73
246500	179	121	2	4.2	2.20	1.10	864	1.65
246600	179	126	2	4.2	2.20	1.10	928	1.65
246700	189	121	2	4.3	2.30	1.15	759	1.73
246800	189	131	2	4.3	2.30	1.15	858	1.73
246900	198	131	2	4.5	2.50	1.25	812	1.88
247000	198	141	2	4.5	2.50	1.25	923	1.88
247100	213	151	2.25	4.5	2.25	1.00	941	1.69
247200	223	161	2.25	4.6	2.35	1.04	942	1.76
247300	228	161	2.25	4.95	2.70	1.20	1036	2.03
247400	238	161	2.25	5.25	3.00	1.33	1021	2.25
247500	248	171	2.5	5	2.50	1.00	1005	1.88
247600	258	171	2.5	5.5	3.00	1.20	1106	2.25
247700	268	181	2.5	5.7	3.20	1.28	1155	2.40
247800	278	181	2.5	6	3.50	1.40	1155	2.63
247900	288	191	2.75	5.75	3.00	1.09	1145	2.25
248000	298	191	2.75	6.35	3.60	1.31	1307	2.70
248100	308	202	3	6.1	3.10	1.03	1300	2.33
248200	318	212	3	6.2	3.20	1.07	1302	2.40
248300	338	232	3	6.6	3.60	1.20	1415	2.70
248400	358	242	3	7	4.00	1.33	1424	3.00

Weight/ 1000 pcs. [kg]	Ball-Bearing Type			Ball-Bearing Dimension			
				Outer dia.	Inner dia.		
36.49	6015			115	75	–	–
64.71			6311	120	–	–	55
52.28		6213		120	–	65	–
54.75	6016	6214		125	80	70	–
71.28			6312	130	–	–	60
57.31	6017	6215		130	85	75	–
85.11			6313	140	–	–	65
69.58	6018	6216		140	90	80	–
120.1			6314	150	–	–	70
100.5	6020	6217		150	100	85	–
138.5			6315	160	–	–	75
118.9	6021	6218		160	105	90	–
149.2			6316	170	–	–	80
127.7	6022	6219		170	110	95	–
213.1			6317	180	–	–	85
197.8	6024	6220		180	120	100	–
258.3			6318	190	–	–	90
227.1		6221		190	–	105	–
270.0			6319	200	–	–	95
236.4	6026	6222		200	130	110	–
310.9		6224 6320		215	–	120	100
328.0	6030		6321	225	150	–	105
359.2		6226		230	–	130	–
423.8	6032		6322	240	160	–	110
494.5		6228		250	–	140	–
572.2	6034		6324	260	170	–	120
598.7		6230		270	–	150	–
682.7	6036		6326	280	180	–	130
783.7	6038	6232		290	190	160	–
883.0			6328	300	–	–	140
995.2	6040	6234		310	200	170	–
1034		6236 6330		320	–	180	150
1112	6044	6238 6332		340	220	190	160
1281	6048	6240 6334		360	240	200	170

∅ 9.8 – 94.5 mm

Slotted springs

Article No.	Ordering Dimensions						Spring Load F and Deflection s at $s \approx 0.75 h_0$	
	D_e [mm]	D_i [mm]	t [mm]	l_0 [mm]	h_0 [mm]	h_{ow}/t	F [N]	s [mm]
241150	9.8	6.2	0.15	0.6	0.45	1.00	13	0.35
241350	12.8	7.2	0.2	0.65	0.45	0.92	18	0.35
241650	15.8	8.2	0.25	0.75	0.50	0.74	20	0.40
241675	18.8	9.2	0.25	1	0.75	0.97	20	0.55
241750	18.8	10.2	0.25	1.05	0.80	1.15	24	0.60
241850	21.8	12.3	0.25	1.25	1.00	1.47	24	0.75
242050	23.7	14.3	0.3	1.3	1.00	1.21	25	0.75
242150	25.7	14.3	0.3	1.4	1.10	1.19	28	0.80
242250	27.7	17.3	0.35	1.45	1.10	1.03	31	0.80
242450	29.7	17.3	0.35	1.55	1.20	1.30	32	0.90
242550	31.7	20.4	0.35	1.55	1.20	1.30	33	0.90
242750	34.6	20.4	0.4	1.65	1.30	1.10	32	1.00
242850	34.6	22.4	0.35	1.55	1.20	1.18	32	0.90
242950	36.6	20.4	0.4	1.9	1.50	1.44	35	1.10
243050	39.6	25.5	0.4	1.9	1.50	1.22	37	1.10
243150	41.6	25.5	0.45	2.05	1.60	1.13	39	1.20
243250	46.5	30.5	0.45	2.05	1.60	1.11	44	1.20
243350	51.5	35.5	0.45	2.1	1.65	1.26	47	1.25
243450	54.5	40.5	0.45	2.15	1.70	1.75	53	1.30
243550	61.5	40.5	0.55	2.55	2.00	1.21	54	1.50
243650	67.5	50.5	0.5	2.6	2.10	1.36	78	1.60
243750	71.5	45.5	0.6	2.9	2.30	1.47	74	1.70
243850	71.5	50.5	0.6	2.9	2.30	1.83	127	1.70
243950	74.5	55.5	0.6	2.9	2.30	1.31	91	1.70
244125	79.5	50.5	0.7	3.1	2.40	1.36	83	1.80
244150	79.5	55.5	0.7	2.9	2.20	1.51	127	1.65
244250	84.5	60.5	0.75	3.15	2.40	0.87	78	1.80
244350	89.5	60.5	0.8	3.3	2.50	1.08	104	1.90
244450	89.5	65.5	0.8	3.4	2.60	1.35	189	1.95
244550	94.5	75.5	0.8	3.45	2.65	1.39	206	2.00

Weight/ 1000 pcs. [kg]	Ball-Bearing Type			Ball-Bearing Dimension			
				Outer dia.	Inner dia.		
0.050	623(EL3)			10	3	–	–
0.130	624(EL4)			13	4	–	–
0.280	625(EL5)	634(R4)		16	5	4	–
0.440	626(EL6)	635(R5)		16	6	5	–
0.320	607(EL7)			19	7	–	–
0.420	608(EL8)	627(R7)		22	8	7	–
0.660	609(EL9)			24	9	–	–
0.700	6000	629(R9)		26	10	9	–
0.984	6001			28	12	–	–
1.200		6200		30	–	10	–
1.270	6002	6201		32	15	12	–
1.650			6300	35	–	–	10
1.500	6003	6202		35	17	15	–
2.280			6301	37	–	–	12
1.920		6203		40	–	17	–
2.500	6004		6302	42	20	–	15
2.840	6005	6204	6303	47	25	20	17
3.070		6205	6304	52	–	25	20
3.200	6006			55	30	–	–
6.050	6007	6206	6305	62	35	30	25
5.500	6008			68	40	–	–
9.600			6306	72	–	–	30
8.200		6207		72	–	35	–
7.580	6009			75	45	–	–
16.26			6307	80	–	–	35
14.50	6010	6208		80	50	40	–
13.00		6209		85	–	45	–
18.10			6308	90	–	–	40
16.00	6011	6210		90	55	50	–
13.30	6012			95	60	–	–

9.6 Dimension Tables for SCHNORR “Z” Disc Springs

Article No.	Designation	Ordering Dimensions						Weight/ 1000 pcs. [kg]	Stress σ_{OM} at $s = h_0$ [N/mm ²]
		D _e [mm]	D _i [mm]	t [mm]	l ₀ [mm]	h ₀ [mm]	h ₀ /t –		
248500	Z 1	9.53	4.96	0.4	0.7	0.30	0.75	0.154	-1687
248600	Z 2	12.7	6.55	0.5	0.9	0.40	0.80	0.348	-1574
248700	Z 3	12.7	6.55	0.6	1	0.40	0.67	0.419	-1888
248800	Z 4	17.46	9.7	0.6	1.1	0.50	0.83	0.750	-1318
248900	Z 5	17.46	9.7	0.7	1.2	0.50	0.71	0.877	-1538
249000	Z 6	19.05	8.13	0.7	1.3	0.60	0.86	1.241	-1342
249100	Z 7	19.05	8.13	0.8	1.4	0.60	0.75	1.370	-1533
249200	Z 8	19.05	9.7	0.8	1.35	0.55	0.69	1.267	-1526
249300	Z 9	19.05	9.7	0.9	1.45	0.55	0.61	1.429	-1717
249400	Z 10	25.4	11.3	0.9	1.7	0.80	0.89	2.766	-1314
249500	Z 11	25.4	11.3	1	1.8	0.80	0.80	3.081	-1460
249600	Z 12	25.4	11.3	1.25	1.9	0.65	0.52	3.867	-1483
249700	Z 12a	28	13	1	1.9	0.90	0.90	3.666	-1376
249800	Z 12b	28	13	1.25	2.1	0.85	0.68	4.564	-1624
249900	Z 12c	28	13	1.5	2.2	0.70	0.47	5.462	-1605
250000	Z 13	34.92	16.18	1.25	2.4	1.15	0.92	7.117	-1412
250100	Z 14	34.92	16.18	1.5	2.6	1.10	0.73	8.517	-1620
250200	Z 15	34.92	16.18	2	2.8	0.80	0.40	11.38	-1571
250300	Z 16	38.1	19.35	1.5	2.9	1.40	0.93	9.574	-1818
250400	Z 17	38.1	19.35	2	3.1	1.10	0.55	12.79	-1905
250500	Z 18	38.1	19.35	2.5	3.4	0.90	0.36	16.13	-1948
250600	Z 19	50.8	25.8	2	3.5	1.50	0.75	22.77	-1461
250700	Z 20	50.8	25.8	2.5	4	1.50	0.60	28.38	-1827
250800	Z 21	50.8	25.8	3	4.2	1.20	0.40	33.87	-1753
250900	Z 22	60.33	25.8	2	4	2.00	1.00	35.66	-1275
251000	Z 23	60.33	25.8	2.5	4.5	2.00	0.80	44.57	-1594
251100	Z 24	60.33	25.8	3	4.6	1.60	0.53	53.30	-1530

Deflection s , Load F and Stress σ

at $s = 0.25 h_0$			$s = 0.50 h_0$			$s \approx 0.75 h_0$			$s = 1.00 h_0$		
s	F	σ	s	F	σ	s	F	σ	s	F_c	σ
[mm]	[N]	[N/mm ²]	[mm]	[N]	[N/mm ²]	[mm]	[N]	[N/mm ²]	[mm]	[N]	[N/mm ²]
0.08	97	535	0.15	171	1005	0.23	231	1412	0.30	283	1753
0.10	146	511	0.20	255	959	0.30	340	1342	0.40	412	1662
0.10	230	569	0.20	415	1074	0.30	571	1515	0.40	712	1892
0.13	181	449	0.25	313	840	0.38	413	1175	0.50	497	1453
0.13	263	490	0.25	470	923	0.38	639	1299	0.50	789	1619
0.15	255	419	0.30	439	783	0.45	576	1091	0.60	688	1345
0.15	352	451	0.30	622	847	0.45	839	1188	0.60	1028	1639
0.14	335	463	0.28	602	873	0.41	824	1230	0.55	1023	1534
0.14	453	498	0.28	830	943	0.41	1156	1334	0.55	1457	1787
0.20	423	424	0.40	722	790	0.60	939	1101	0.80	1114	1354
0.20	543	449	0.40	948	840	0.60	1261	1176	0.80	1529	1469
0.16	714	385	0.33	1336	756	0.49	1896	1043	0.65	2426	1769
0.23	552	453	0.45	939	846	0.68	1218	1177	0.90	1441	1448
0.21	866	474	0.43	1559	893	0.64	2138	1258	0.85	2658	1718
0.18	1081	409	0.35	2046	838	0.53	2933	1117	0.70	3783	1922
0.29	898	470	0.58	1522	875	0.86	1962	1217	1.15	2310	1495
0.28	1291	487	0.55	2294	916	0.83	3104	1286	1.10	3818	1659
0.20	1818	411	0.40	3489	873	0.60	5060	1054	0.80	6582	1953
0.35	1683	630	0.70	2842	1175	1.05	3651	1633	1.40	4285	2006
0.28	2391	531	0.55	4442	1009	0.83	6268	1435	1.10	7980	2059
0.23	3459	502	0.45	6686	1059	0.68	9757	1327	0.90	12752	2341
0.38	2095	459	0.75	3706	863	1.13	4994	1211	1.50	6121	1504
0.38	3695	525	0.75	6784	995	1.13	9470	1410	1.50	11955	1916
0.30	4565	442	0.60	8759	920	0.90	12705	1221	1.20	16526	2062
0.50	2211	429	1.00	3672	797	1.50	4631	1103	2.00	5341	1349
0.50	3703	483	1.00	6467	904	1.50	8605	1264	2.00	10431	1647
0.40	4278	395	0.80	7979	791	1.20	11295	1067	1.60	14419	1858

Security Elements for Bolted Connections



Chapter 10

10.1 Original SCHNORR Serrated Safety Washers (Rib Washers)	139
Dimension Table for “S” Series Serrated Safety Washers (Rib Washers).....	140
Dimension Table for “VS” Series Serrated Safety Washers (Rib Washers)	142
10.2 Load Washers	143
Heavy Duty Safety Washers-HDS as per DIN 6796	143
Dimension Table for HDS Washers as per DIN 6796.....	144
10.3 SCHNORR High Load Safety Washers “HS”	146
Dimension Table for “HS” Washers.....	146

10.1 Original SCHNORR Serrated Safety Washers (Rib washers)

Very often our disc springs are considered for use as serrated safety washers for bolted connections to maintain a preload and prevent loosening. High quality disc springs are too expensive for this application and the sizes of normal disc springs do not match screw and bolt sizes. We have therefore developed special safety elements for this application.

These serrated safety washers are in the form of a disc spring which is serrated on both sides and of trapezoidal cross section. Their diameters are matched to screw dimensions. The outer diameter of the washer is matched to the head diameter of pan-head and hexagon socket head cap screws. As a result, the serrated safety washer can be used with practically any screw and bolt type, including those with recessed heads. The only exception are countersunk screws.

The ingenious form of the Original Schnorr Serrated Safety Washer combines the advantages of security through friction and mechanical locking. They offer the following advantages to the designer:

1. The shape of the cross section ensures the locking effect is at the outside diameter which ensures the greatest resistance to loosening.
2. High resistance to vibration due to positive locking of the serrations.
3. The closed ring form results in a high degree of pretensioning, i.e. an excellent frictional connection.
4. Concentric application of force eliminates bending in the bolts.
5. Sliding surfaces allow tightening without damaging the surfaces.

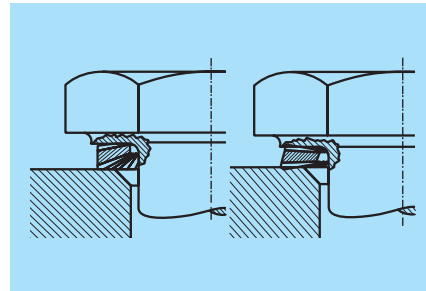

Figure 42
Bolt with SCHNORR Serrated Safety Washer loose and tightened

6. No splitting during tightening with proper transitional radius between bolt shaft and bolt head.
7. Suitable for captive fitting on a wide range of bolts (combi bolts for which a range with special dimensions is available).
8. Universal application minimises stocks.
9. Schnorr Serrated Safety Washers can be supplied in a variety of materials and different finishes.

The Original Schnorr Serrated Safety Washer is available in two series:

The “S” series is suitable for normal duty and available for screws of size M1.6 to M36. The reinforced serrated safety washer of the “VS” series is thicker, and therefore achieves higher pretensioning loads. The inner and outer diameters are the same as for the “S” series. These washers are available for screws M 5 to M 30.

The Original SCHNORR Serrated Safety Washer is protected by patents at home and abroad.

Dimension Table for “S” Series Serrated Safety Washers (Rib Washers)

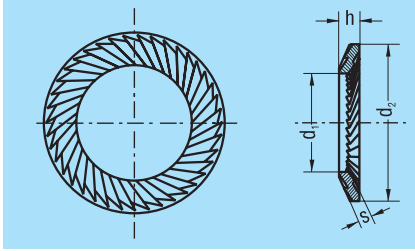

Figure 43
Original SCHNORR Serrated Safety Washer type “S”

Designation for an Original SCHNORR Serrated Safety Washer type “S” size 8 in spring steel: Serrated Safety Washer S 8 FSt.

Article No.	Size (Nominal) [mm]	d ₁ H14 [mm]	d ₂ h14 [mm]	s [mm]	h [mm]		Weight (7.85 kg/dm ³) [kg/1000 pcs.]	Packaging [pcs. per box]	for bolts	
					max.	min.			metric [mm]	imperial [in.]
402300	1.6	1.7	3.2	0.35	0.6	0.38	0.013	2000	1.6	
404400	2	2.2	4	0.35	0.6	0.39	0.021	2000	2	
406800	2.5	2.7	4.8	0.45	0.9	0.49	0.039	2000	2.5	
409400	3	3.2	5.5	0.45	0.9	0.51	0.049	2000	3	1/8"
411200	3.5	3.7	6	0.45	0.9	0.52	0.055	2000	3.5	
412700	4	4.3	7	0.5	1.0	0.59	0.085	1000	4	5/32"
414500	5	5.3	9	0.6	1.1	0.73	0.167	1000	5	3/16"
416300	6	6.4	10	0.7	1.2	0.82	0.200	1000	6	
418100	6.35	6.7	9.5	0.7	1.2	0.79	0.150	1000		1/4"
419200	7	7.4	12	0.7	1.3	0.89	0.355	1000	7	
420400	8	8.4	13	0.8	1.4	0.98	0.392	1000	8	5/16"
423000	10	10.5	16	1	1.6	1.21	0.750	1000	10	3/8"
425100	11.1	11.6	15.9	1	1.6	1.18	0.595	500		7/16"
426200	12	13	18	1.1	1.7	1.31	0.879	500	12	
427900	12.7	13.7	19	1.1	1.8	1.33	0.976	500		1/2"
429100	14	15	22	1.2	2.0	1.52	1.641	500	14	9/16"
430700	16	17	24	1.3	2.1	1.63	1.984	500	16	5/8"
432400	18	19	27	1.5	2.3	1.85	2.970	250	18	

Article No.	Size (Nominal) [mm]	d ₁	d ₂	s	h	h	Weight (7.85 kg/dm ³) [kg/1000 pcs.]	Packaging [pcs. per box]	for bolts	
		H14 [mm]	h14 [mm]	max.	min.	metric [mm]			imperial [inch.]	
433800	19	20	30	1.5	2.5	1.98	4.100	250		³ / ₄ "
435100	20	21	30	1.5	2.5	1.94	3.742	250	20	
436600	22	23	33	1.5	2.7	2.08	4.507	100	22	⁷ / ₈ "
437900	24	25.6	36	1.8	2.9	2.32	5.910	100	24	
439200	25.4	27	38	2	3.1	2.52	7.449	100		1"
440300	27	28.6	39	2	3.1	2.52	7.369	100	27	
441500	30	31.6	45	2	3.6	2.78	10.78	100	30	1 ¹ / ₈ "
442730	36	38	54	2.5	4.2	3.38	21.28	50	36	1 ³ / ₈ "

Article No.: Valid for normal execution (spring steel, hardened, blackened)

h max.: Maximum dimension as delivered

h min.: Minimum height after loading test

Available

materials:

Available finishes:

Spring steel as per DIN EN 10132-4;

corrosion resistant steel 1.4301; spring bronze CuSn8.

blackened, (Standard), browned, phosphated, zinc-plated, cadmium-plated

Dimension Table for “VS” Series Serrated Safety Washers (Rib Washers)

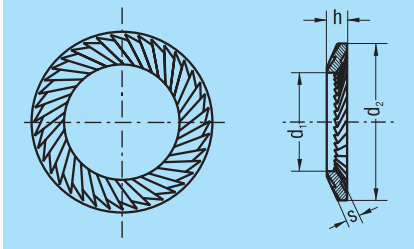

Figure 44
Original SCHNORR Serrated Safety Washer type „VS“

Designation for an Original SCHNORR Serrated Safety Washer type “VS” size 16 of spring steel with a mechanically zinc-plated, yellow-chromated surface:

Serrated Safety Washer VS 16 Fst mech Zn8 cC.

Article No.	Size (Nominal) [mm]	d ₁	d ₂	s	h	h	Weight (7.85 kg/dm ³) [kg/1000 pcs.]	Packaging [pcs. per box]	for bolts	
		H14 [mm]	h14 [mm]	max.	min.	[mm]			[mm]	metric [mm]
414600	5	5.3	9	1	1.3	1.07	0.273	1000	5	3/16"
416400	6	6.4	10	1	1.4	1.08	0.300	1000	6	
420500	8	8.4	13	1.2	1.7	1.32	0.615	1000	8	5/16"
423100	10	10.5	16	1.5	2	1.64	1.167	1000	10	3/8"
426300	12	13	18	1.5	2.1	1.65	1.223	500	12	
429200	14	15	22	1.5	2.2	1.76	2.089	500	14	9/16"
430800	16	17	24	2	2.6	2.21	3.142	250	16	5/8"
432500	18	19	27	2	2.7	2.27	4.041	250	18	
435300	20	21	30	2	2.8	2.34	5.066	250	20	
436700	22	23	33	2	3.0	2.42	6.117	100	22	7/8"
438000	24	25.6	36	2.5	3.4	2.87	8.865	100	24	
440400	27	28.6	39	2.5	3.5	2.91	9.731	100	27	
441600	30	31.6	45	2.5	3.8	3.12	14.380	100	30	1 1/8"

Article No.: Valid for normal execution (spring steel, hardened, blackened)

h max.: Maximum dimension as delivered

h min.: Minimum height after loading test

Available materials:

Available finishes:

Spring steel as per DIN 10132-4; corrosion resistant steel 1.4301; spring bronze CuSn8.

blackened, (Standard), browned, phosphated, zinc-plated, cadmium-plated

10.2 Load Washers

The term “load washer” is used to describe a spring element in the form of a disc spring which achieves its locking effect solely by means of the frictional connection. These are intended to compensate for loosening of the screwed connection, e.g. due to setting, by maintaining a sufficiently high pretension in the connection with spring force. They are therefore especially suitable for primarily axially loaded, short bolts. They provide no effective security against unscrewing due to alternating lateral loading.

Schnorr Load Washers offer the following advantages:

1. High axial load
2. Optimum compensation for setting in the joint
3. Reduction of the dynamic loading of the screw due to higher elasticity of the joint
4. Uniform concentric loading eliminates bending in the bolt
5. Greater safety with high degree of spring action
6. Suitable for captive fitting on a wide range of bolts (combi bolts)

Heavy Duty Safety Washers (HDS) as per DIN 6796

These HDS washers have been specifically developed for high-strength bolts in the strength classes 8.8 – 10.9 as per DIN ISO 898 Part 1 (SAE Grade 5). The loads of the washers have been matched to these bolts and are 70 to 90% of the bolt load in the flat state.

These high loads naturally require large cross-sections, which is why the outside diameter of the load washer is considerably larger than that of our Original SCHNORR Serrated Safety Washers. As a result, the area required for a design with load washers cannot be ignored.

As a highly progressive load increase occurs at the end of the spring deflection when the washer is flattened, the load has been indicated as double the calculated value in the following table. Tests have shown that these values are comparable with the measured values.

The HDS washers contained in the table conform to DIN 6796, Edition October 1987 “Conical spring washers for bolted connections.” The test specifications are laid down in DIN 267 Part 26 “Fasteners; technical specifications for elements made of spring steel for bolted connections.”

Dimension Table for HDS Washers as per DIN 6796

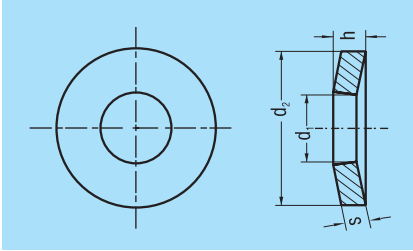

Figure 45
HDS Washer

Designation of a load washer size 8 of spring steel: HDS Washer DIN 6796-8 FSt.

Article No.	Size (Nominal) [mm]	d ₁ H 14 [mm]	d ₂ h14 [mm]	s [mm]	h max. [mm]	h min. [mm]
700000	2	2.2	5	0.4	0.6	0.5
700100	2.5	2.7	6	0.5	0.72	0.61
700200	3	3.2	7	0.6	0.85	0.72
700300	3.5	3.7	8	0.8	1.06	0.92
700400	4	4.3	9	1	1.3	1.12
700500	5	5.3	11	1.2	1.55	1.35
700600	6	6.4	14	1.5	2	1.7
700700	7	7.4	17	1.75	2.3	2
700800	8	8.4	18	2	2.6	2.24
700900	10	10.5	23	2.5	3.2	2.8
701000	12	13	29	3	3.95	3.43
701100	14	15	35	3.5	4.65	4.04
701200	16	17	39	4	5.25	4.58
701300	18	19	42	4.5	5.8	5.08
701400	20	21	45	5	6.4	5.6
701500	22	23	49	5.5	7.05	6.15
701600	24	25	56	6	7.75	6.77
701700	27	28	60	6.5	8.35	7.3
701800	30	31	70	7	9.2	8

Article No.: Valid for the normal execution in spring steel, hardened, blank and oiled

h max.: Maximum height as delivered

h min.: Minimum height after the setting test as per DIN 267 part 26

Spring Load: Double the calculated spring force in the flat condition for a deflection $h_{min} - s$

Test Load: Proof load for setting test as per DIN 267 part 26

Spring Load	Test Load	Weight (7.85 kg/dm ³) [kg/1000 pcs.]	for bolts	
			metric [mm]	imperial [inch]
[N]	[N]			
628	920	0.050	2	
946	1540	0.089	2.5	
1320	2350	0.143	3	1/8"
2410	3160	0.248	3.5	
3770	4050	0.385	4	5/32"
5480	6700	0.687	5	3/16"
8590	9400	1.434	6	(1/4")
11300	13700	2.527	7	
14900	17200	2.993	8	5/16"
22100	27500	6.201	10	3/8"
34100	40000	12.05	12	(1/2")
46000	55000	21.58	14	9/16"
59700	75000	29.61	16	5/8"
74400	95000	37.93	18	
93200	122000	47.63	20	(3/4")
113700	152000	62.04	22	7/8"
131000	175000	90.88	24	
154000	230000	110.5	27	(1")
172000	280000	166.9	30	1 1/8"

Technical specifications: as per DIN 267 part 26
 Material: Spring steel to DIN EN 10132-4 or DIN 17221
 Surface finish: Blank and oiled

Other materials and surface finishes available on request.

10.3 SCHNORR High Load Safety Washers „HS“

This safety washer is in principle a HDS washer with a smaller outer diameter than those in DIN 6796.

A notable feature of these washers is the slightly curved form, which provides a progressively increasing characteristic curve. Despite the smaller outside dimensions, this

makes it possible to achieve the same load as the HDS washers as per DIN 6796.

These washers are primarily used when the space available is insufficient for standardized load washers.

Dimension Table for “HS” Washers

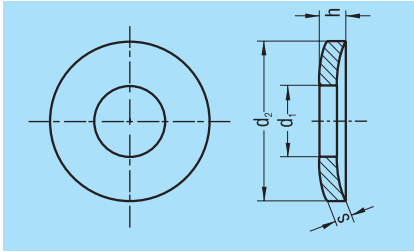

Designation of a SCHNORR High Load Safety Washer size 12 of spring steel:
Safety Washer HS 12 - FSt.

Figure 46
Original SCHNORR High Load Safety Washer “HS”

Article No.	Size (Nominal) [mm]	d ₁ H 14 [mm]	d ₂ h14 [mm]	s [mm]	h max. [mm]	h min. [mm]
416320	6	6.4	12	1.5	1.9	1.64
416520	8	8.4	17	2	2.55	2.21
423220	10	10.5	21	2.5	3.15	2.75
426400	12	13	24	3	3.75	3.27
429320	14	15	28	3.5	4.35	3.8
430900	16	17	30	4	4.95	4.31
433750	18	19	33	4.5	5.5	4.8
435320	20	21	36	5	5.95	5.3
436620	22	23	40	5.5	6.7	5.9
439150	24	25	45	6	7.3	6.45
440100	27	28	50	6.5	8	7
442650	30	31	58	7	8.9	7.65

Article No.: Valid for the normal execution in spring steel, hardened, phosphated and oiled

h max.: Maximum height as delivered
h min.: Minimum height after the setting test as per DIN 267 part 26

Spring Load: Double the calculated spring force in the flat condition for a deflection $h_{min} - s$
Test Load: Proof load for setting test as per DIN 267 part 26

Spring Load	Test Load	Weight (7.85 kg/dm ³) [kg/1000 pcs.]	Packaging [pcs. per box]	for bolts	
				metric [mm]	imperial [inch]
8920	9400	0.943	2500	6	(1/4")
15100	17200	2.438	1000	8	5/16"
23200	27500	4.915	500	10	3/8"
34800	40000	7.194	250	12	(1/2")
44800	55000	11.61	100	14	9/16"
62800	75000	14.50	100	16	5/8"
72600	95000	19.36	100	18	
92200	122000	25.33	100	20	(3/4")
120000	152000	35.07	100	22	7/8"
135000	175000	50.28	50	24	
155000	230000	66.94	50	27	(1")
180000	280000	101.0	50	30	1 1/8"

Technical specifications: as per DIN 267 part 26
 Material: Spring steel to DIN EN 10132-4 or DIN 17221
 Surface finish: Phosphated and oiled

Other materials and surface finishes available on request.

Standards

DIN EN	10048	Hot-rolled narrow steel strip – Tolerances on dimensions and shape
DIN EN	10140	Colled rolled steel
DIN	2092	Disc springs; calculation
DIN	2093	Disc springs; dimensions and quality specifications
DIN	7521	Steel forgings; technical terms of delivery
DIN	17221	Hot rolled steels for quenched and tempered springs
DIN EN	10132-4	Cold-rolled narrow steel strip for heat-treatment Part 4: Spring steels and other applications
DIN EN	10151	Wire and strip of stainless steels for springs
DIN EN	10269	Steel and nickel alloys for fasteners with specified elevated and/or low temperature properties
DIN EN	1652	Copper and copper alloys– Plate, sheet, strip and circles for general purposes
DIN EN	1654	Copper and copper alloys – Strip for springs and connectors
DIN	50938	Alkaline blackening (black finishing) of iron materials
DIN	50942	Phosphating of metals
DIN	50960	Electroplated and chemical coatings; designation and specification in technical documents
DIN EN	10258	Cold-rolled stainless steel narrow strip and cut lengths – Tolerances on dimensions and shape
DIN EN	10029	Hot rolled steel plates 3 mm thick or above; Tolerances on dimensions, shape and mass
DIN EN	10088-2	Stainless steels

Further Sources

- [1] Dubois, Fr.: Über die Festigkeit der Kegelschale
Dissertation, Zürich 1917
- [2] Almen, J.O.; László, A.: The Uniform-Section Disk Spring
Trans. ASME 58 (1936), S. 305 – 314
- [3] Hertzner, K. H.: Über die Dauerfestigkeit und das Setzen von Tellerfedern
Dissertation TH Braunschweig 1959
- [4] Lutz, O.: Zur Berechnung der Tellerfeder
Konstruktion 12 (1960) 2, S. 57 – 59
- [5] Schremmer, G.: Über die dynamische Festigkeit von Tellerfedern
Dissertation TH Braunschweig 1965
- [6] Bühl, P.: Zur Spannungsberechnung von Tellerfedern
DRAHT 22 (1971) 11, S. 760 – 763
- [7] Schremmer, G.: Die geschlitzte Tellerfeder
Konstruktion 24 (1972) 6, S. 226 – 229
- [8] Bühl, P.: Maximale Höhen bei Tellerfedern aus Sonderwerkstoffen
DRAHT 25 (1974) 2, S. 63 – 65
- [9] Bühl, P.: Mechanische Schwingungen bei Tellerfedersäulen
DRAHT 28 (1977) 2, S. 48 – 53
- [10] Curti, G.; Orlando, M.: Ein neues Berechnungsverfahren für Tellerfedern
DRAHT 30 (1979) 1, S. 17 – 22
- [11] Bühl, P.: Tellerfedern – gedreht oder feingeschnitten
DRAHT 31 (1980) 5, S. 295 – 299
- [12] Curti, G.; Orlando, M.; Vereinfachtes Verfahren zur Berechnung von Tellerfedern
Podda, G.: DRAHT 31 (1980) 11, S. 789 – 792
- [13] Niepage, P.: Vergleich verschiedener Verfahren zur Berechnung von Tellerfedern
DRAHT 34 (1983) 3, S. 105 – 108 und 5, S. 251 – 255

Please send your Enquiry Sheet to: Schnorr Corporation
4355 Varsity Drive Suite A
Ann Arbor, MI 48108
Fax 734-975-0408
Phone 734-677-2683
eMail sales@schnorr.com
Internet <http://www.schnorr.com>

