



4-20 mA Amplified Series Melt Pressure Transmitters With AutoZero “A” Series

This manual covers the following products:

DYN-X-MA, DYN-X-MA-TC

PT4604, PT4624, TPT4634

PT4184, PT4194, TPT4194











EPR4, EPR4-TC

PT4674, PT4654XL

Operating Manual



Table of Contents

Content	Page	Icon
General	3	
Notes on safety	5	
Technical data	7	
Function	21	
Transport/delivery	22	
Installation	23	
Commissioning	29	
Maintenance	32	
Accessories	35	
Troubleshooting	35	
CE- Declaration of conformity	36	



1. GENERAL



1.1	Important information	3
1.2	Copyright	4
1.3	Explanation of icons	4
1.4	Abbreviations	4
1.5	Correct use	5
1.6	User's obligations	5

1.1 IMPORTANT INFORMATION

This manual applies to 2 wire AutoZero transmitters only, which include:

- DYN-X-MA...-A
- DYN-X-MA..TC-A
- PT4604...-A
- PT4624...-A
- TPT4634...-A
- PT4184...-A
- PT4194...-A
- TPT4194...-A
- EPR4...-A
- EPR4...TC-A
- PT4674...-A
- PT4654XL...A

It must be kept near the equipment in a readily and immediately accessible location at all times.

The content of this manual must be read, understood and followed in its entirety. This applies in particular to the notes on safety. Following the safety instructions will help to prevent accidents, defects and malfunctions.

DYNISCO will not be held liable for any injury, loss or damage resulting from failure to follow the instructions in this manual.



If the product malfunctions, in spite of having followed the operating instructions, please contact the **DYNISCO** customer service department (see the back of the manual for contact information).

1.2 COPYRIGHT

Copyright law requires that this manual be used for in-house purposes only. All reproduction, even partially and for in-house purposes, requires the approval of **DYNISCO**. This manual may not be forwarded to third parties.

1.3 EXPLANATION OF ICONS

The manual uses icons to indicate information pertaining to safety:

ATTENTION Risk of destruction or damage to equipment, machines or installations



General danger to life or limb



Specific danger to life or limb



You **MUST** do this

The safety instructions are provided again in the individual chapters of the manual.

1.4 ABBREVIATIONS

The following abbreviations are used:

- OM** Operating manual
- f.s.** of full scale
- PT** pressure transmitter



1.5 CORRECT USE



The purpose of the 4 - 20 mA Aut Zero Amplified Pressure Transmitters is to measure pressure in plastic melt as part of an overall larger system. It contains an integral signal amplifier. The pressure transmitters are specified to be used in media temperatures up to 400oC, except for the oil filled transmitters (PT4194 and TPT4194), which are specified to 275oC continuous and for NaK filled transmitters (B171 and B628 options), which are specified to 518oC .

If the PT is used in other applications, the safety and accident prevention regulations specific to that application must be followed.

When using the PT as a safety component in accordance with the EC Machine Directive, ANNEX IIc, the equipment manufacturer must take any necessary precautions to ensure that malfunctions of the PT cannot cause damage or injury.

1.6 USER'S OBLIGATIONS

The operator or owner of the larger overall system, e.g. a machine, is responsible for following the safety and accident prevention regulations that apply to the specific application.

2. NOTES ON SAFETY



The operator or owner of the larger overall system is responsible for following the safety and accident prevention regulations that apply to the specific application.



Toxic hazard!

The PT may contain a small amount of mercury (Hg) as its transmission medium. If the diaphragm is damaged, mercury may escape. Other configurations will contain NaK, a Sodium Potassium fill fluid, and others may contain a food grade oil. Both NaK and the food grade oil meet the requirements of the FDA and the USDA for food and medical applications.



Never transport or store the PT without the protective cap.
Remove the cap shortly before installation.



If mercury or NaK is inhaled or swallowed, seek medical attention immediately!

Mercury is hazardous waste and must be disposed of in accordance with applicable laws. **DYNISCO** will accept defective PTs.

If mercury escapes, use airtight packaging!



When planning machinery and using the PT, follow the safety and accident prevention regulations that apply to your application, e.g.:

- EN 60204, Electrical equipment in machines.
- EN 292, Machine safety, general design guidelines.
- DIN 57 100 Part 410, Protection against electric shock.



Mounting and electrical connection of the PT must be done by specialists with EMC training, following all applicable regulations, and in **pressureless, voltage-free** condition with the **machine switched off**.

The machine must be secured against being switched back on!



Burn hazard!

The PT must be removed with the melt in molten condition. The PT can be very hot when removed.



Wear protective gloves!

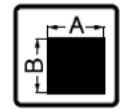

3. TECHNICAL DATA

3.1 Ordering guides	8
3.1.1 Ordering guide for DYN-X-MA Series	8
3.1.2 Ordering guide for XPT46X4 Series	8
3.1.3 Ordering guide for XPT41X4Series	9
3.1.4 Ordering guide for EPR4 Series	9
3.1.5 Ordering guide for PT4674 Series	9
3.1.6 Ordering guide for PT4654XL Series	10
3.2 Ordering example	10
3.3 Performance characteristics	10
3.3.1 Accuracy	10
3.3.2 Resolution	11
3.3.3 Repeatability	11
3.4 Mechanical configurations	11
3.5 Pressure side connection	12
3.6 Pressure ranges	13
3.6.1 Max. overload	13
3.6.2 Burst pressure	13
3.6.3 Natural frequency	13
3.7 Rigid stem/flexible stem	14
3.7.1 Rigid stem/flexible stem for DYN-X-MA, XPT46X4, XPT41X4, EPR4	14
3.7.2 Exposed capillary/flexible stem for PT4674	14
3.7.3 Armored cable for PT4654XL	14
3.8 Electrical data	14
3.9 Temperature influence	15
3.10 EMC requirements	15
3.11 Materials	16
3.12 Mounting torque	16
3.13 Environmental protection	16
3.14 Weight	16
3.15 Dimensions	16

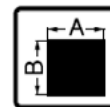

3.1 ORDERING GUIDES

The exact meanings of the letter/digit combinations are given in the corresponding sections of chapter 3.

3.1.1 ORDERING GUIDE FOR DYN-X-MA SERIES

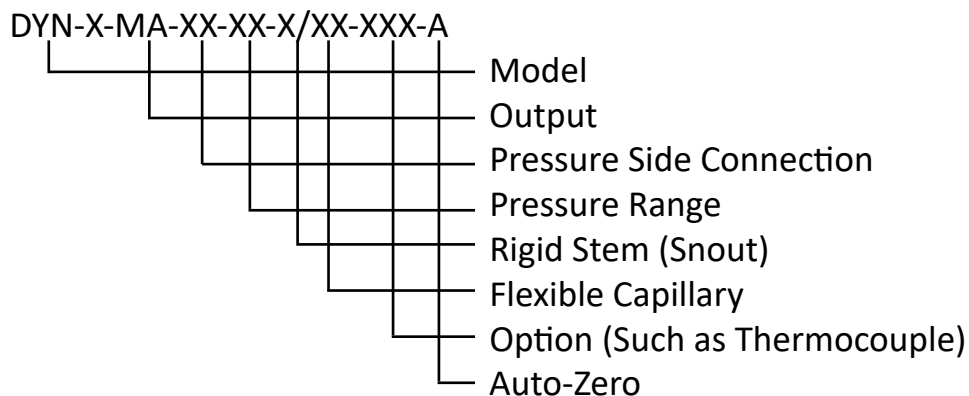

3.1.2 ORDERING GUIDE FOR XPT46X4 SERIES

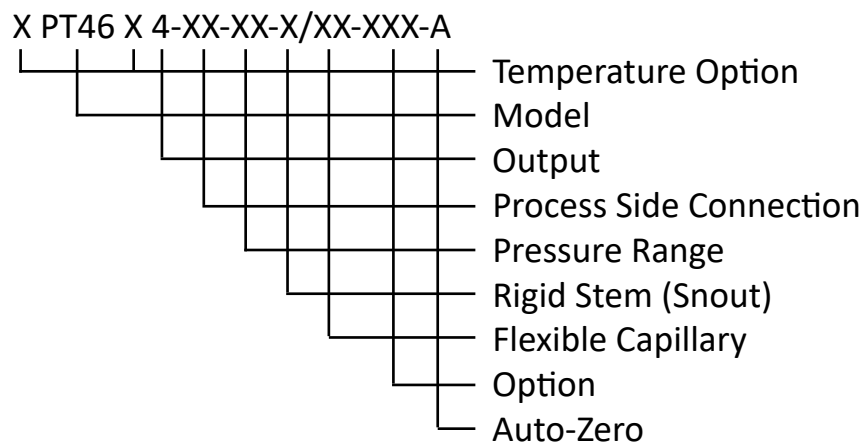

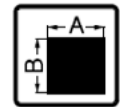

3.1.3 ORDERING GUIDE FOR XPT4184, XPT4194 SERIES

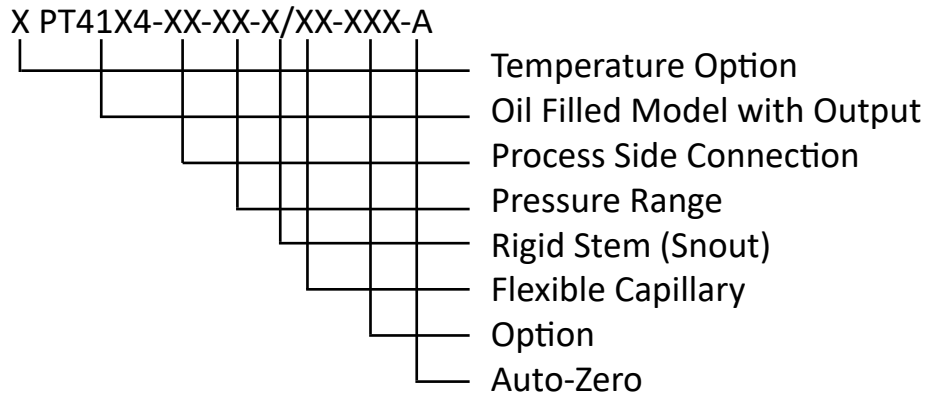

3.1.4 ORDERING GUIDE FOR EPR4 SERIES

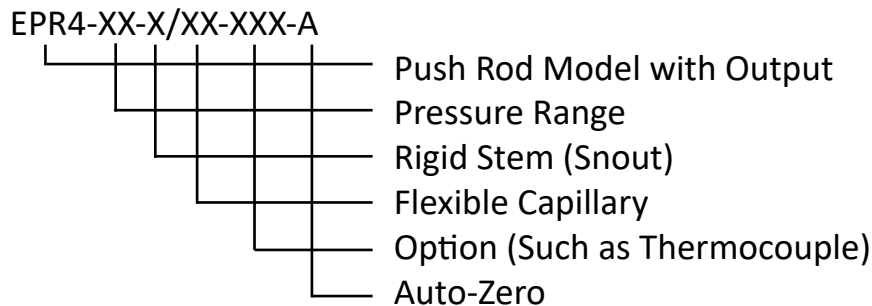

3.1.5 ORDERING GUIDE FOR PT4674

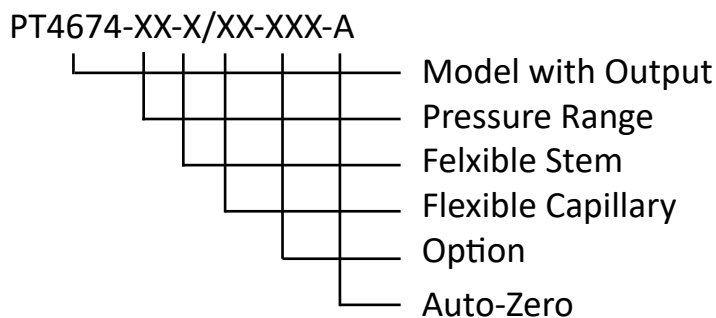

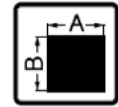

3.1.6 ORDERING GUIDE FOR PT4654XL

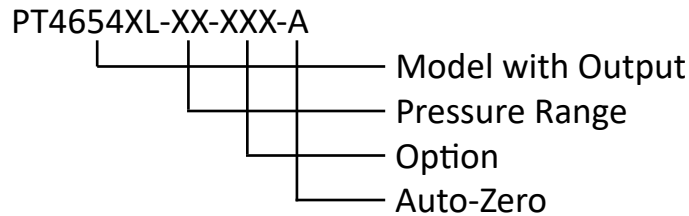

3.2 ORDERING EXAMPLE

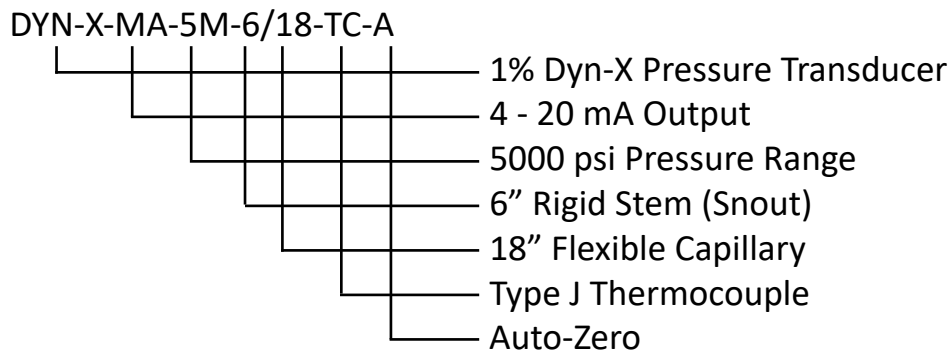

3.3 PERFORMANCE CHARACTERISTICS

3.3.1 ACCURACY (COMBINED ERROR)

(Linearity, hysteresis and repeatability)

3.3.1A DYN-X-MA, DYN-X-MA-TC

±1.0% of full scale
(0-500 psi and above)

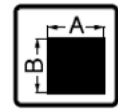

3.3.1B PT4604, PT4624, TPT4634, PT4184, PT4194, TPT4194, EPR4, EPR4-TC, PT4674

±0.50% of full scale (0-500 psi and above)

3.3.2 RESOLUTION

Infinite

3.3.3 REPEATABILITY

±0.20% of full scale

3.4 MECHANICAL CONFIGURATIONS

DYN-X-MA = Rigid Stem or Rigid Stem with Flexible Capillary

DYN-X-MA-TC = Rigid Stem, Flexible Capillary and Thermocouple (Combined pressure and temperature measurement)

PT4604 = Rigid Stem Version

PT4624 = Rigid Stem with Flexible Capillary

TPT4634 = Rigid Stem, Flexible Capillary and Thermocouple (Combined pressure and temperature measurement)

PT4184 = Rigid Stem Version

PT4194 = Rigid Stem with Flexible Capillary

TPT4194 = Rigid Stem, Flexible Capillary and Thermocouple (Combined pressure and temperature measurement)

EPR4 = Rigid Stem or Rigid Stem with Flexible Capillary

EPR4-TC = Rigid Stem, Flexible Capillary and Thermocouple (Combined pressure and temperature measurement)

PT4674 = Jam Nut with Exposed Capillary with Flexible Capillary

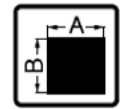

PT4654XL = Jam Nut with Armored Capillary

3.5 PRESSURE SIDE CONNECTIONS

3.5.1 PRESSURE SIDE CONNECTION FOR DYN-X (DYN-X-MA-XX-XX-X/XX-XXX-A)

blank = 1/2-20 UNF
M18 = M18 x 1.5

3.5.2 PRESSURE SIDE CONNECTION FOR XPT46X4 (XPT46X4-XX-XX-X/XX-XXX-A)

blank = 1/2-20 UNF
M18 = M18 x 1.5

3.5.3 PRESSURE SIDE CONNECTION FOR XPT4184 & XPT4194 (XPT41X4-XX-XX-X/ XX-XXX-A)

blank = 1/2-20 UNF
M18 = M18 x 1.5

3.5.4 PRESSURE SIDE CONNECTION FOR EPR4 (EPR4-XX-XX-X/XX-XXX-A)

blank = 1/2-20 UNF

3.5.5 PRESSURE SIDE CONNECTION FOR PT4674 (PT4674-XX-XX/XX-XXX-A)

1/2-20 UNF Jam Nut



3.5.6 PRESSURE SIDE CONNECTION FOR PT4654XL (PT4654XL-XX-XXX-A)

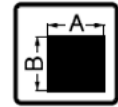

1/2-20 UNF Jam Nut

3.6 PRESSURE RANGES IN PSI

Model Number	Permitted Pressure Range in PSI	
5C	0-500	(Excluding XPT4184, XPT4194, EPR4, PT4654XL)
7.5C	0-750	(Excluding XPT4184, XPT4194, EPR4, PT4654XL)
1M	0-1,000	(Excluding EPR4, PT4654XL)
1.5M	0-1,500	(Excluding PT4654XL)
3M	0-3,000	
5M	0-5,000	
7.5M	0-7,500	
10M	0-10,000	
15M	0-15,000	(XPT46X4, PT4674, PT4654XL only)
20M	0-20,000	(XPT46X4, PT4674, PT4654XL only)
30M	0-30,000	(XPT46X4, PT4674 only)

Other pressure ranges may be available. Please consult factory.

3.6.1 MAX. OVERLOAD (WITHOUT INFLUENCING OPERATING DATA)

DYN-X-MA	2 x full scale pressure
XPT46X4	2x full scale pressure or 35,000 psi, whichever is less
XPT4194	2x full scale pressure or 35,000 psi, whichever is less
EPR4	1.5x full scale pressure
PT4674	2 x full scale pressure or 35,000 psi, whichever is less
PT4654XL	2 x full scale pressure or 35,000 psi, whichever is less

3.6.2 BURST PRESSURE

6 x nominal value, max. 45,000 psi

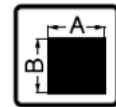

3.6.3 NATURAL FREQUENCY

50 Hz [-3db]

3.7 STEM/FLEXIBLE STEM

3.7.1 RIGID STEM/FLEXIBLE CAPILLARY FOR DYN-X-MA, XPT46X4, XPT4184, XPT4194, EPR4

6 = 152 mm standard length for rigid version
6/18 = 152 mm stem length / 457 mm flexible stem

Other lengths available

3.7.2 EXPOSED CAPILLARY/FLEXIBLE CAPILLARY FOR PT4674

10/18 = 10" exposed capillary length / 18" flexible stem
Other lengths available

3.7.3 ARMORED CABLE FOR PT4654XL

28 = 28" armored capillary length (standard, is left blank in model code)
Other lengths available

3.8 ELECTRICAL DATA

Configuration	4-arm Wheatstone bridge strain gauge with int. amplifier
Output signal	2-wire 4 - 20 mA
Supply voltage	14-36 Vdc
Calibration function	80% +/- 0.5% of full scale output by externally connecting pins E = CAL and F = GND

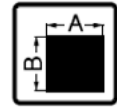

3.9 TEMPERATURE INFLUENCE

Electronics housing

Max. housing temperature	-25°C to +85°C
Compensated temperature range	0°C to +70°C
Zero shift due to temperature change on electronics housing	0.02% f.s./10°C typical

Diaphragm (in contact with media)

DYN-X-MA, XPT46X4, EPR4, PT4674, PT4654XL

Maximum temperature at the diaphragm	400°C (750°F)
--------------------------------------	---------------

XPT4184, XPT4194

Maximum temperature at the diaphragm	275°C (525°F), continuous use
--------------------------------------	-------------------------------

Zero shift due to temperature change on the diaphragm

DYN-X-MA, XPT46X4, PT4674	25 psi/100°F typical (45 psi/100°C)
XPT4184, XPT4194	36 psi/100°F typical (65 psi/100°C)
EPR4	1% f.s./100°F typical (2% f.s./100°C)
PT4654XL	< 20 psi/100°F typical (36 psi/100°C)

3.10 EMC REQUIREMENTS

Conforming to CE in accordance with EMC directive.

Emitted Interference	DIN EN 50081-1 (residential area)
Immunity	DIN EN 50082-2 (industrial area)

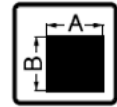

3.11 MATERIALS

DYN-X-MA, XPT46X4, XPT4184, XPT4194, EPR4
Diaphragm 15-5PH Mat. No. 1.4545 DyMax™ coated
Stem 17-4PH Mat. No. 517400
PT4654XL
Diaphragm Inconel 718

3.12 TORQUE

max. 56.5 Nm
(500 inch-lbs.)
min. 11.3 Nm
(100 inch-lbs.)

3.13 ENVIRONMENTAL PROTECTION TO IEC 529

PT housing without connector IP54
PT06A-10-6S (std connector) IP40
PT06W-10-6S IP64

3.14 WEIGHT

1-2 lbs.

3.15 DIMENSIONS

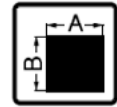

Fig. 3-1 DYN-X-MA, PT4604,
PT4184, Rigid Configuration

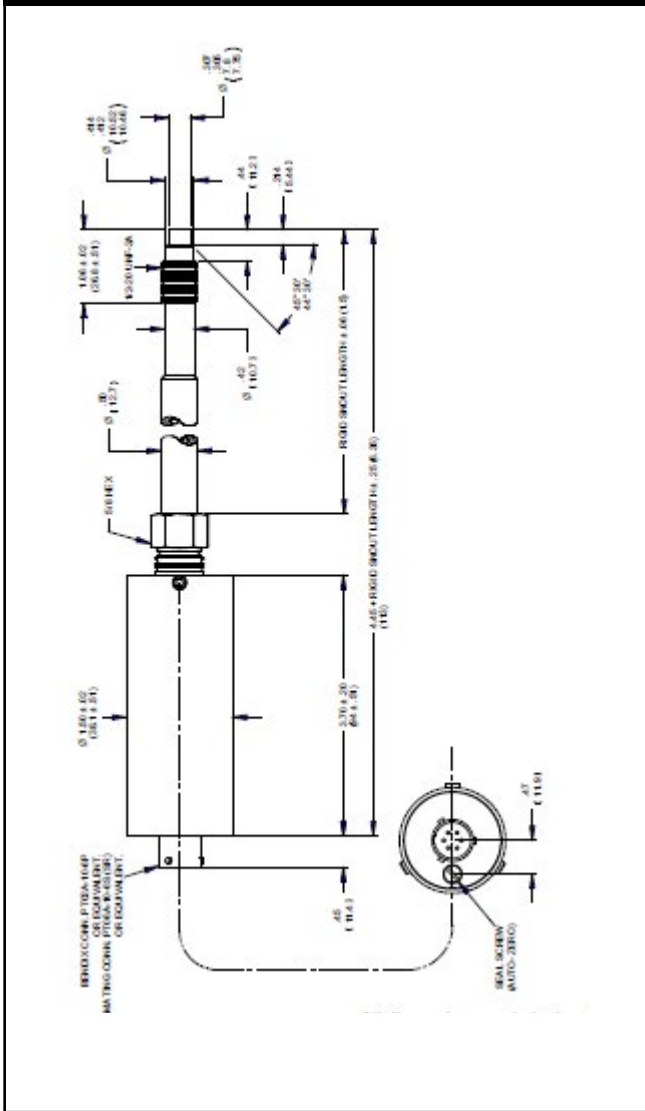
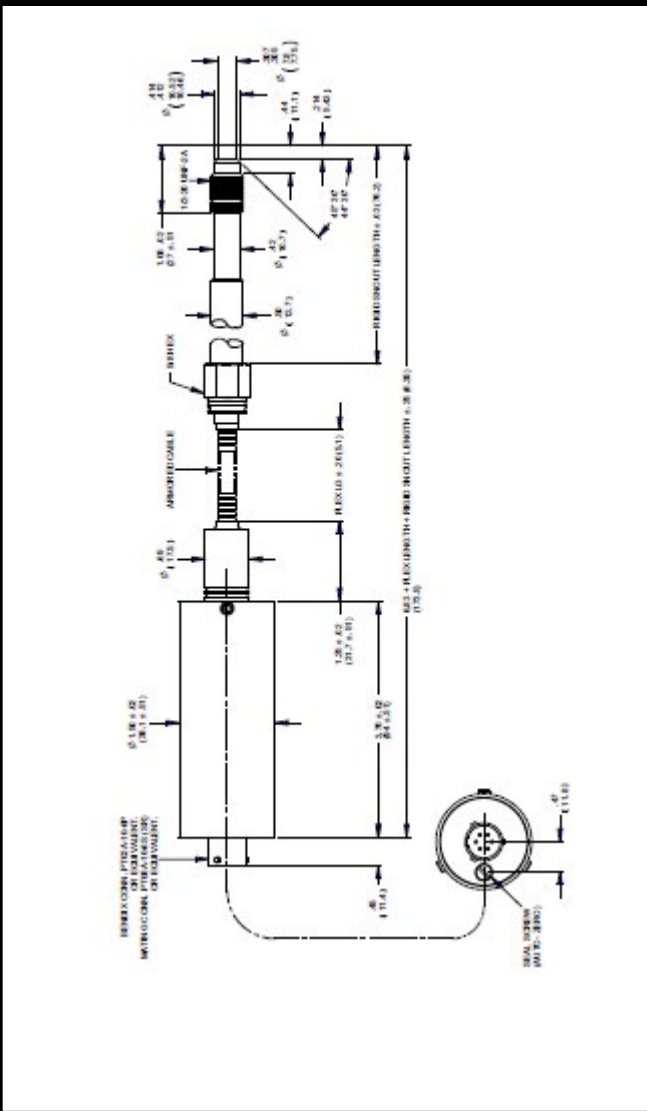

Fig. 3-2 DYN-X-MA, PT4624, PT4194
Rigid & Flex Configuration



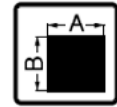

Fig. 3-3 DYN-X-MA-TC, TPT4634, TPT4194
Rigid, Flex & Temp Configuration

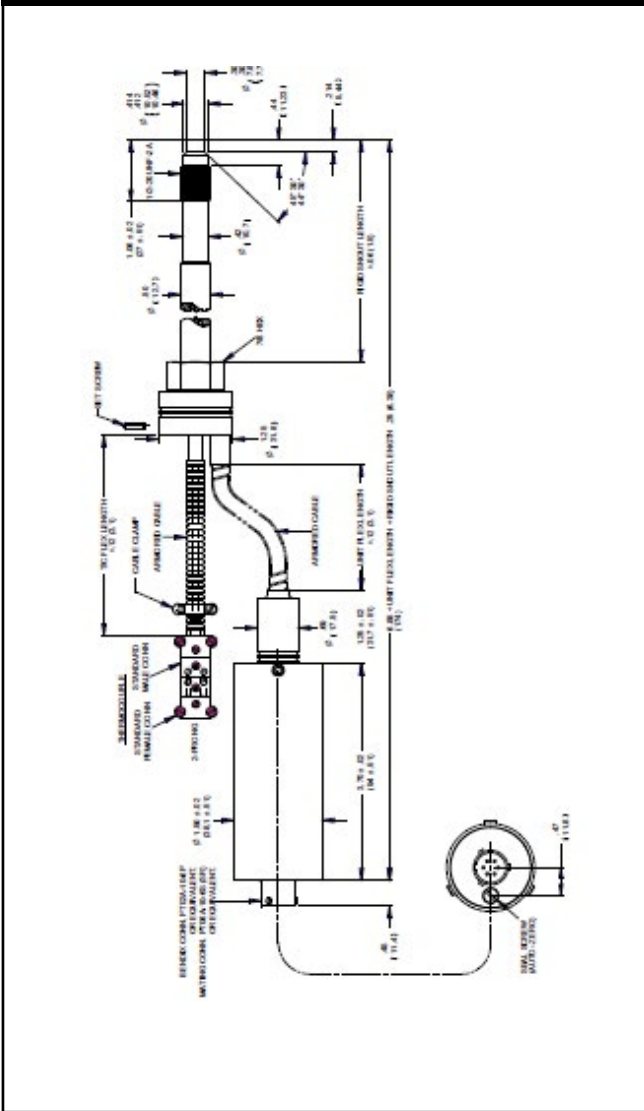
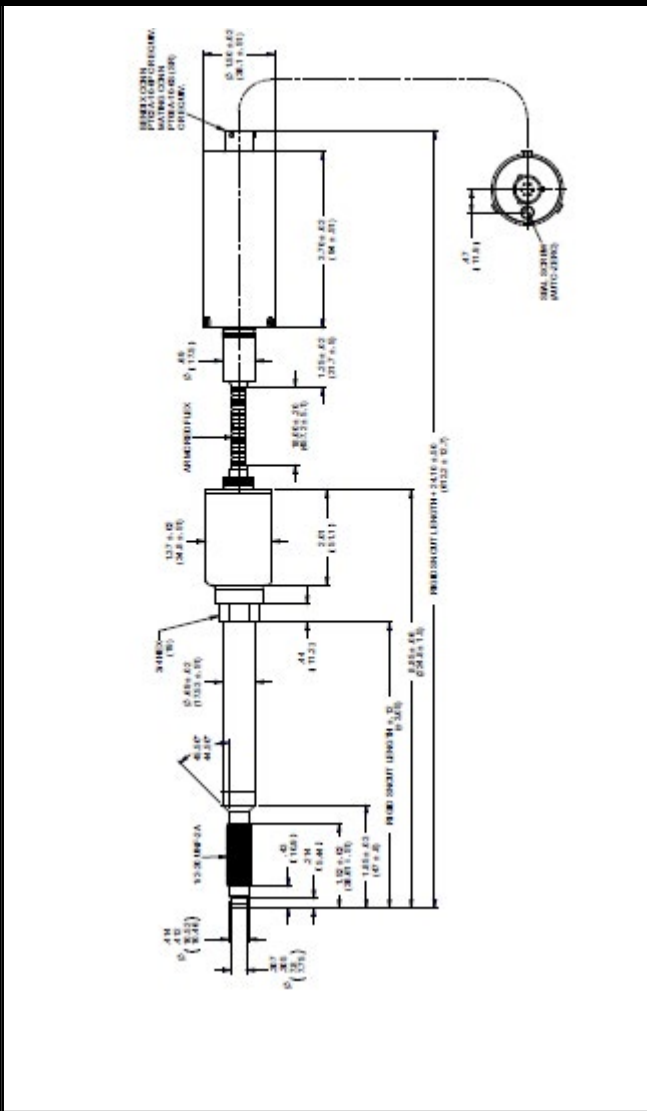

Fig. 3-4 EPR4 Rigid & Flex Configuration



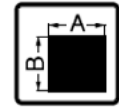

Fig. 3-5 EPR4-TC Rigid, Flex & Temp Configuration

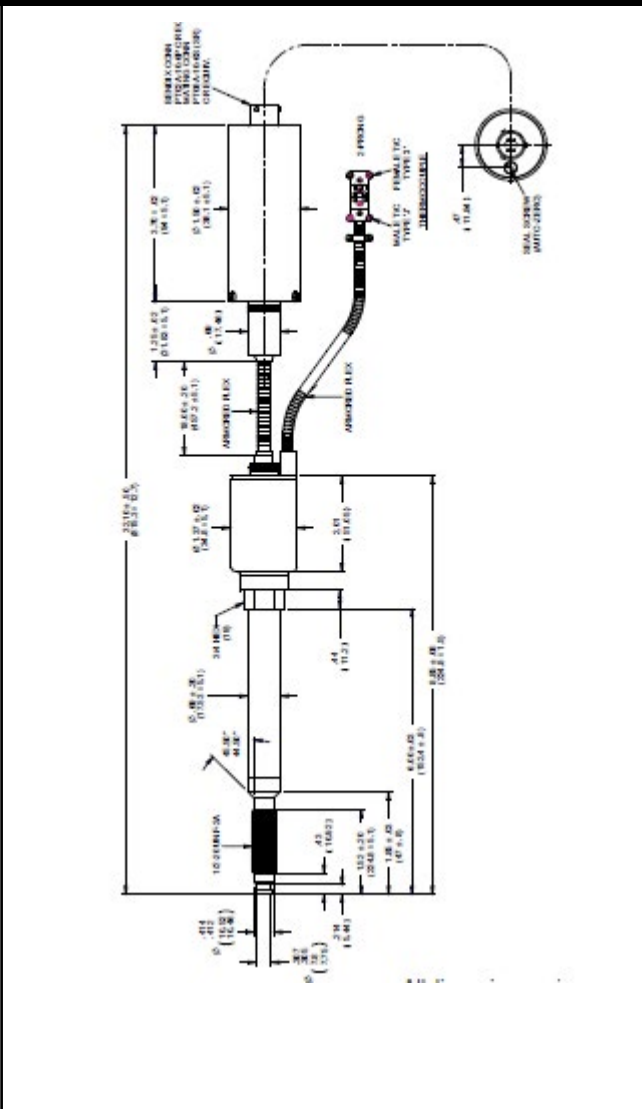
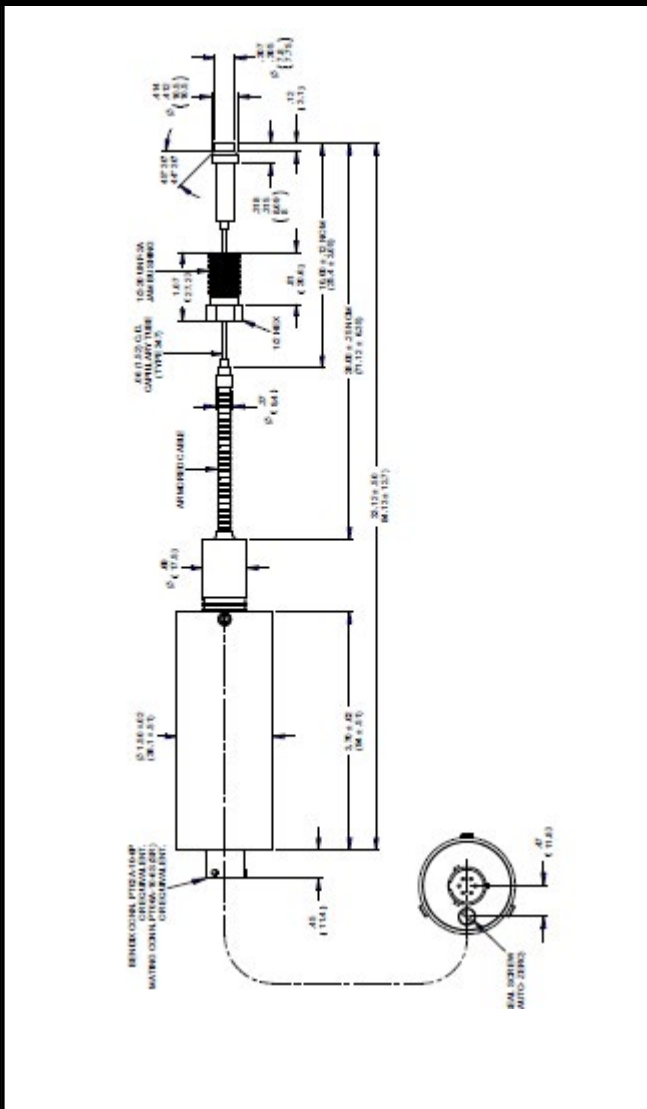

Fig. 3-6 PT4674 Configuration



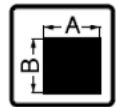
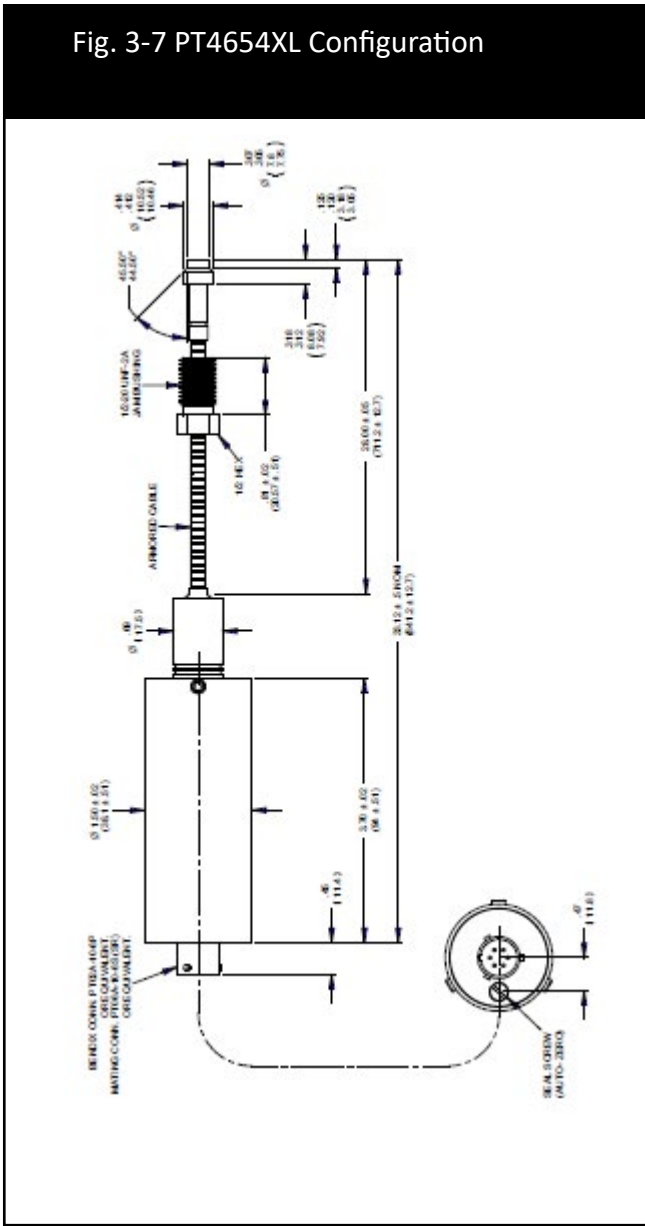

Fig. 3-7 PT4654XL Configuration





4. FUNCTION

4.1 CONSTRUCTION

The PTs of the 4 - 20 mA Auto Zero amplified series are industry standard.

The main advantages are:

- manufactured under ISO9001:2000
- thermal stability
- resistance to aggressive media
- insensitivity to electromagnetic radiation (EMC)
- liquid-filled transmission system (mercury, oil or NaK)
- pressure measurements in plastic melt up to a temperature of 518°C

4.2 DESCRIPTION OF FUNCTIONS

Through a closed, liquid-filled pressure transmission system, the PT furnishes an electrical signal that is proportional to the pressure of the melt.

The pressure applied by the medium is forwarded to the measuring diaphragm and the liquid fill in the capillary. The deflection of the measuring diaphragm changes the resistance of the strain gauge bonded to the measuring diaphragm. The strain gauge is a Wheatstone bridge.

Depending on the model, the integrated amplifier generates an electrical signal (mA) proportional to the pressure.

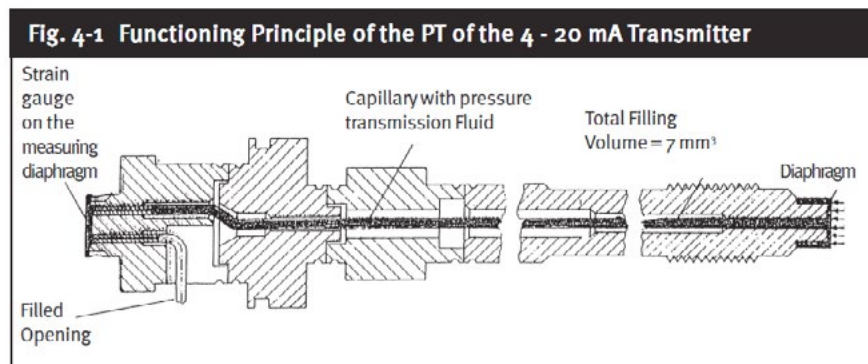



5. TRANSPORT / DELIVERY



Toxic hazard!

The PT may contain a small amount of mercury (Hg) as its transmission medium. If the diaphragm is damaged, mercury may escape. Other configurations will contain NaK, a Sodium Potassium fill fluid, and others may contain a food grade oil. Both NaK and the food grade oil meet the requirements of the FDA and the USDA for food and medical applications.

Never transport or store the PT without the protective shell bolted in place. Remove the shell shortly before installation.

If mercury or NaK is inhaled or swallowed, seek medical attention immediately.

Mercury is hazardous waste and must be disposed of in accordance with applicable laws. **DYNISCO** will accept defective PTs.

If mercury escapes, use airtight packaging!

ATTENTION

ESD sensitive component. Electrostatic discharge may damage the PT. Take ESD precautions.

5.1 TRANSPORT/PACKING/TRANSPORT DAMAGE

- Do not let the PT be damaged by other items during transit.
- Use only the original packaging.
- Report transport damage to DYNISCO immediately in writing.

5.2 STORAGE

- Store the PT in original packaging only.
- Protect against dust and moisture.

5.3 SCOPE OF DELIVERY

- PT with diaphragm protection cap
- Fastening clip (transmitter with flexible stem only)
- Calibration sheet
- Operating manual with declaration of conformity



6. ASSEMBLY

6.1 Mounting hole	23
6.2 Checking the mounting hole	25
6.3 Mounting the Pressure Transmitter	26
6.4 Mounting PTs with flexible stem	27
6.5 Electrical connection	28
6.5.1 EMC / CE compliant connection	28
6.6 Connection assignments	29



Ambient temperature for the electronics housing max. +85°C. Higher temperatures can result in damage and malfunction.

Do not install the pressure transmitter in places where this temperature is exceeded.

6.1 MOUNTING HOLE

To produce the mounting hole, use only DYNISCO machining tool kit (DYNISCO P/N 200925).

ATTENTION

- Drill the mounting hole as shown in fig. 6-1, 6-2, 6-3, 6-4.

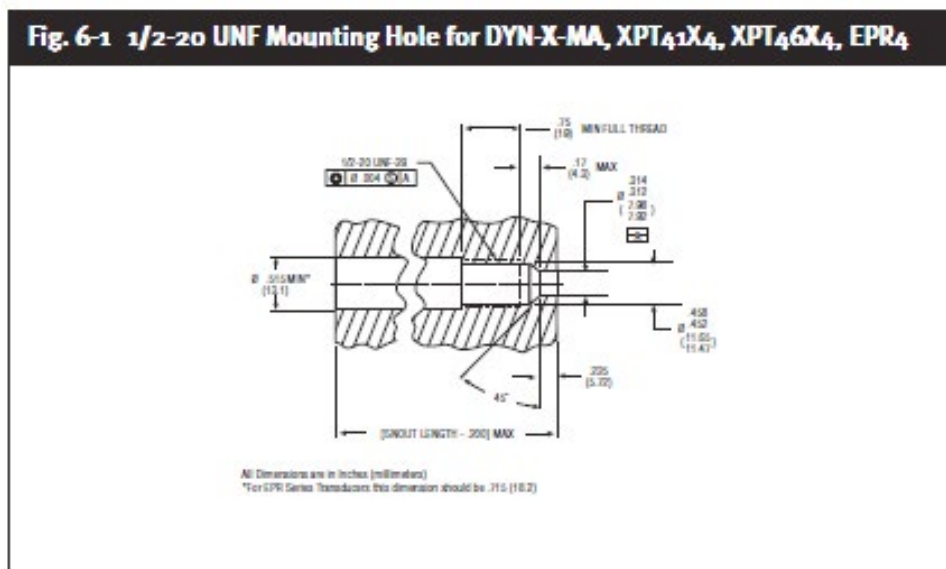



Fig. 6-2 M18 x 1.5 Mounting Hole for DYN-X-MA, XPT4184, XPT46X4

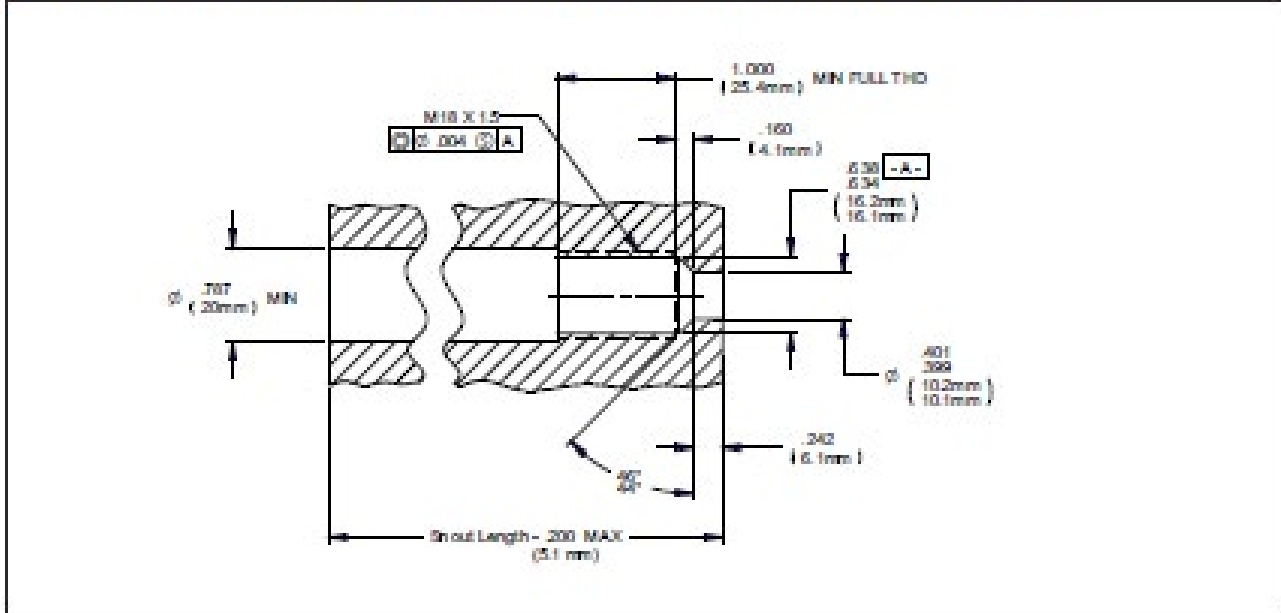
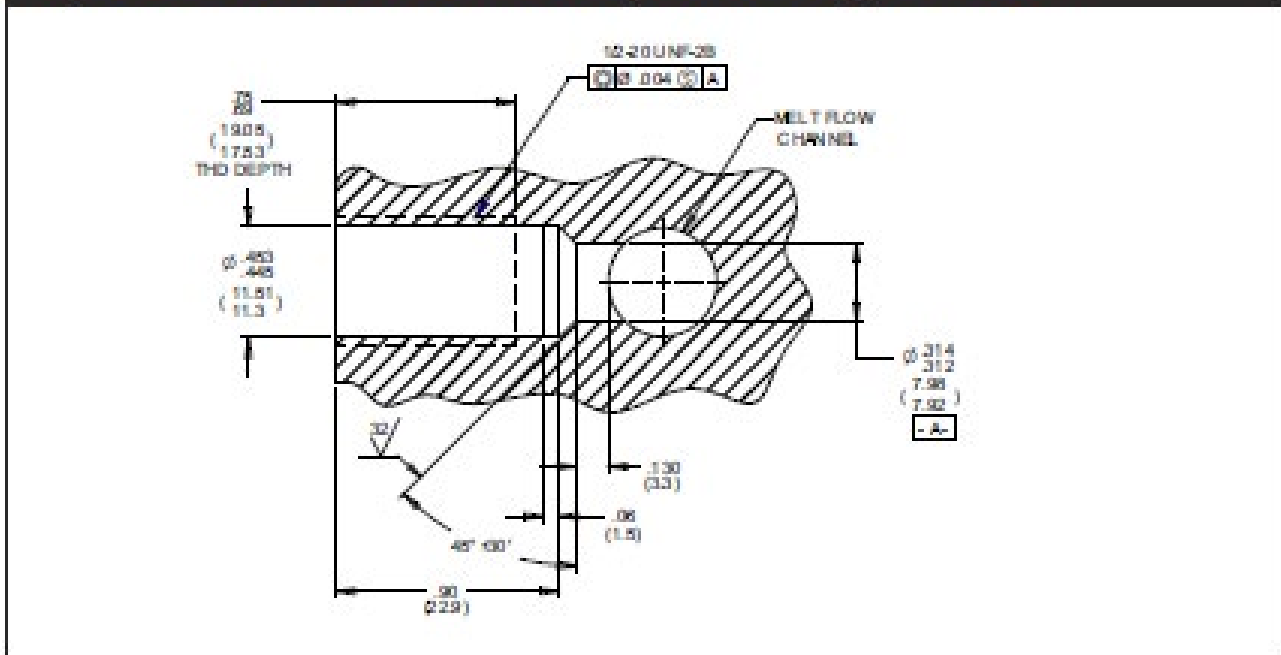

Fig. 6-3 1/2-20 UNF Jam Nut Mounting Hole for PT4674, PT4654XL





When reworking the mounting hole, pay particular attention to the centricity of:

- the hole,
- the thread, and
- the sealing surface.

Pressure sealing takes place on the 45° beveled sealing surface and on the front cylindrical section of the PT (see figures 6-1, 6-2, 6-3).

The sealing surface must be:

- correctly machined
- free from marks and rough edges
- free from solidified plastic residue.

6.2 CHECKING THE MOUNTING HOLE

- Paint the test bolt DYNISCO on the marked area (figure 6-4, item 1) with marking ink up to the thread.



- Insert the test bolt in the mounting hole.
- Twist it in by hand until the two sealing surfaces make contact.
- Remove and examine the test bolt.

The only acceptable abrasion of marking ink is at the sealing edge (45°), evenly over the entire circumference.

If the ink has been rubbed off in other places as well rework the mounting hole.



6.3 MOUNTING THE PRESSURE TRANSMITTER



Mounting and electrical connection of the PT must be done by specialists with EMC training, following all applicable regulations, and in **pressureless, voltage-free, intrinsically safe** condition with the machine switched off.

The machine must be secured against being switched back on!

Toxic hazard!

The PT may contain a small amount of mercury (Hg) as its transmission medium. If the diaphragm is damaged, mercury may escape. Other configurations will contain NaK, a Sodium Potassium fill fluid, and others may contain a food grade oil. Both NaK and the food grade oil meet the requirements of the FDA and the USDA for food and medical applications.

Never transport or store the PT without the protective shell bolted in place. Remove the shell shortly before installation.

If mercury or NaK is inhaled or swallowed, seek medical attention immediately.

ATTENTION ESD sensitive component. Electrostatic discharge may damage the PT. Take ESD precautions.

ATTENTION Before mounting the PT, check the mounting hole carefully. The PT must only be mounted in holes that satisfy the requirements stipulated in chapter 6.1. A hole that does not satisfy these requirements can damage the PT.

ATTENTION Before mounting the PT, ensure that the mounting hole is free from plastic residue. Remove plastic residue with the DYNISCO cleaning tool kit. A test bolt is included with this cleaning set.

ATTENTION To prevent the PT from sticking permanently in the mounting hole, coat the thread section of the transmitter with high temperature resistant grease or a suitable parting agent.



- Check the mounting hole with the test bolt, and clean with cleaning set if necessary.
- Coat the thread section of the transmitter with high temperature resistant grease or a suitable parting agent.

ATTENTION Always use a torque wrench applied to the designated hexagon collar when screwing the PT in and out. Do not apply the tool to the housing or housing / sensor connection!

ATTENTION Maximum mounting torque 500 inch-pounds for 1/2-20 UNF transmitters. If the mounting torque is too high, the PT may be damaged or its zero point may shift.

- Screw the PT into the mounting hole and tighten.

6.4 MOUNTING PTS WITH FLEXIBLE STEM

Mounting a PT with a flexible stem to the pressure sensor is done analogously to the procedure in 6.3.

ATTENTION Avoid kinking or crushing the flexible stem.

Minimum bending radius

- 1" (25 mm) for protected capillary
- 0.08" (2 mm) for unprotected capillary (PT4674)

The connector must be easily accessible (on connector versions).

- Mount the electronics housing of the PT with the fastening clip. See mounting example in figure 6-5.
- Additionally secure the flexible stem between the electronics housing with a standard cable clip.

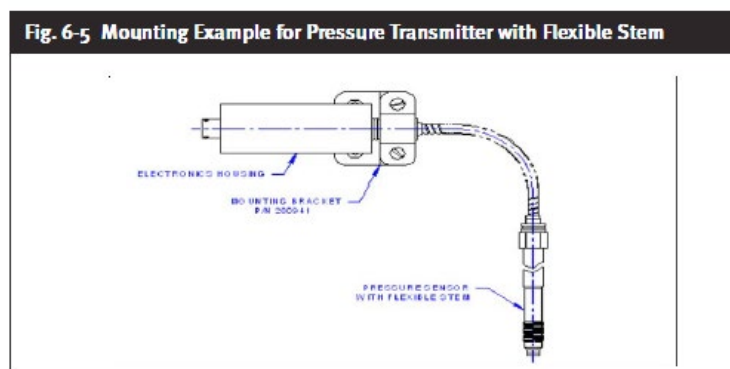



6.5 ELECTRICAL CONNECTION



Mounting and electrical connection of the PT must be done by specialists with EMC training, following all applicable regulations, and in **pressureless, voltage-free, intrinsically safe** condition with the **machine switched off**.

ATTENTION

The machine must be secured against being switched back on! ESD sensitive component. Electrostatic discharge may damage the PT. Take ESD precautions.

ATTENTION

Avoid laying the power cable in the direct vicinity of cables carrying higher voltages or switching inductive or capacitive loads.

ATTENTION

An EMC compliant power supply must be used. The electrical connection must comply with EMC requirements.

ATTENTION

If the electrical connection is not made as described in chapter 6.6, or if cables / cable connectors / cable glands other than those stipulated by DYNISCO are used, DYNISCO cannot guarantee that EMC requirements will be satisfied.

6.5.1 EMC / CE COMPLIANT CONNECTION

- Ground the machine element with the screw-in trunnion / mounting hole for the PT in accordance with regulations. The PT must be connected to earth via the screw-in trunnion / mounting hole.
- Connect the shield of the connecting cable on both sides, making sure it conducts with full and continuous contact.
- When introducing the connecting cable into an EMC compliant switch cabinet, for example, connect the shield correctly (cable gland, conducting, full contact, continuous) to the conductive housing or route it via built-in cable connector that is also connected to the conductive housing.
- Connect unused cable cores or free cable ends correctly to the cable shield on both sides.



6.6 CONNECTION ASSIGNMENTS

Connection assignments for standard 4 - 20 mA transmitters, including:
DYN-X-MA, XPT46X4, XPT41X4, EPR4, PT4674, PT4654XL

PIN	Designation
A	Signal (+)
B	Signal (-)
C	NC
D	Auto-Zero
E	Shunt Cal
F	Ground

The connector housing is connected conductively to the housing of the PT.

To activate Auto-Zero without using the push button, cross pins D & F.
To activate Shunt Calibration, cross pins E & F.

7. COMMISSIONING



7.1 Supply voltage	29
7.2 Calibration	30
7.3 Zero adjustment	30
7.4 Zero adjustment of oil-filled sensors	31
7.5 Operations	32

ATTENTION Before putting the PT into operation, make sure the PT is securely mounted and sealed.

7.1 SUPPLY VOLTAGE

ATTENTION Using a supply voltage which is different from the stated in the technical specifications or has reversed polarity can damage the PT or cause it to malfunction. Please read the entire manual prior to installation and use.



7.2 CALIBRATION CHECK

It is not necessary to calibrate the PT, as it has already been calibrated at the factory. These 4 - 20 mA Series of amplified pressure transmitters have an internal calibration signal. Connecting terminals E and F switches the calibration signal to the signal output. It is 80% of the full scale pressure of the transmitter.

ATTENTION If desired, check the factory calibration in pressureless state and at room temperature. Other temperatures may provide incorrect data.

7.3 ZERO ADJUSTMENT

Use a small allen key (less than 2 mm in diameter)!
The zero adjustment is made using the Auto Zero push-button located beneath the protective screw on top of the electronics housing.

- Remove the cap screw from the Auto Zero push-button.

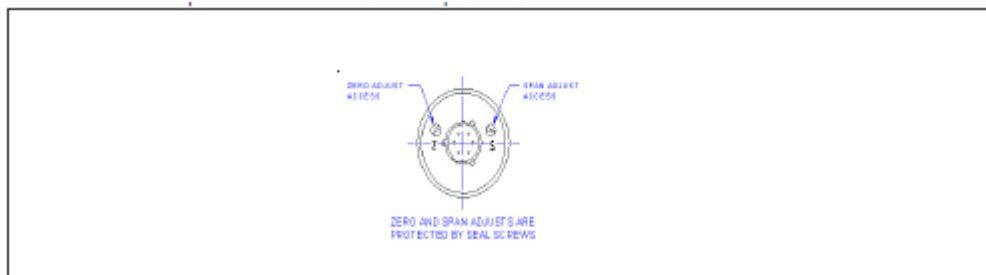

- Connect the pressure transmitter to a DCS, PLC, meter or suitable instrument so to display the signal output to verify the pressure reading.
- Wait until a steady operating temperature is reached at the pressure sensor.
- Press the Auto Zero push-button and verify the reading on the meter.
- Replace the cover screw on the Auto Zero button.

ATTENTION Do not change the installed position of the PT after Auto Zeroing. If the position is changed you must rezero the PT.



7.4 ZERO ADJUSTMENT OF THE OIL-FILLED SENSOR



Description

An oil sensor has the advantage of being non-toxic and therefore compliant for many foods, medical or other critical applications. A disadvantage of an oil-filled system is that the organic oil fill can degrade over time at high temperatures. Over a period of months and continuously operating at elevated temperatures ($>275^{\circ}\text{C}$ / 525°F), some long chain molecules in the oil can degrade and generate gas molecules. While in continued operation, these gases remain in solution in the oil and have no effect on the performance of the sensor. However, if/when the sensor is returned to room temperature and zero pressure, the gas may come out of the solution (outgas) over a short period of time (minutes to hours), creating a bubble(s) in a closed fill system. At non-operating room temperature and zero pressure, the gas exerts a small additional pressure (on the order of 50-100 psi) and results in an apparent increase in the Zero Output. Therefore, the gas offset error represents a higher percentage of oil which has degraded over time at temperature.

When the sensor is returned to operation with increased pressure and temperature, the gas bubble(s) will go back into solution. Testing has shown that the gas is typically reabsorbed with temperatures exceeding 100°C / 212°F . With the gas reabsorbed, the sensor is reading the true pressure at specified accuracies. When the sensor is installed and brought to operating temperature and before applying pressure, it can then be re-zeroed without any impact on the calibration accuracy.

Recommended Zero Adjustment

Prior to performing a zero adjustment, it is recommended that the system is installed and the equipment brought to process temperature ($>100^{\circ}\text{C}$) at or near zero pressure. This will allow any gas to be absorbed into the oil and eliminate offset effects.

If a zero adjustment is conducted at less than 100°C (e.g., bench calibration test port), briefly pressurize to ≥ 150 psi/10 bar, then depressurize the system prior to performing the zero adjustment. Pressurizing followed by depressurizing will temporarily allow any gas to be absorbed into the oil and eliminate offset effects. Verify that the zero output value will be repeated by reapplying pressure to ≥ 150 psi/10 bar followed by depressurizing.



7.5 OPERATION



ATTENTION Before starting the machine, wait until the melt medium at the diaphragm of the PT has reached its operating/processing temperature. If the machine is started before the medium reaches its operating temperature, the PT will be damaged. If it is hard to tell when the operating temperature has been reached, use a combined PT with thermocouple.

ATTENTION Depending on the fill type, operating temperature at the PT diaphragm is **max. 400°C (752°F)** for mercury filled transmitters. Operating temperature at the PT diaphragm is **max. 275°C (525°F)** continuous operation for food grade oil filled transmitters. Operating temperature at the PT diaphragm is **max. 518°C (1000°F)** for NaK filled transmitters. Temperatures higher than the maximum recommended temperatures will damage the PT.



Ambient temperature for the electronics housing **max. +85°C** . Higher temperatures can result in damage and malfunction.

Do not install the pressure transmitter in places where this temperature is exceeded.

8. MAINTENANCE



8.1 Maintenance	32
8.2 Thermocouple/RTD replacement	33
8.3 Repair/disposal	34
8.4 Warranty	35

8.1 MAINTENANCE



Mounting and electrical connection of the PT must be done by specialists with EMC training, following all applicable regulations, and in **pressureless, voltage-free, intrinsically safe** condition with the **machine switched off**.



The machine must be secured against being switched back on!
Burn hazard!



The PT must be removed with the melt in molten condition. The PT can be very hot when removed.



Wear protective gloves!

ESD sensitive component. Electrostatic discharge may damage the PT. Take ESD precautions.



Always remove the PT before cleaning the machine with abrasives or steel wire brushes or suchlike.



Before removing the PT, the medium must be in molten condition.



Removing the transmitter with the medium in solidified condition can damage the diaphragm of the PT.



Do not clean the screw-in section of the PT with hard objects. This will damage the PT!



Always use a torque wrench applied to the designated hexagon collar when screwing the PT in and out. Do not apply the tool to the housing or housing/sensor connection!

- Remove the PT.
- Carefully clean the diaphragm of the transmitter with a soft cloth, while the medium is still malleable.

8.2 THERMOCOUPLE/RTD REPLACEMENT

A defective thermocouple is easy to replace.

- Loosen the hexagon socket screw at the top end of the sensor stem.
- Remove the defective thermocouple from the probe stem.



When fitting the new thermocouple, the pressure transmitting capillary must be located in the slot of the thermocouple.

- Insert the new thermocouple all the way into the probe stem.
- Tighten the hexagon socket screw at the top of the sensor stem to secure the thermocouple.

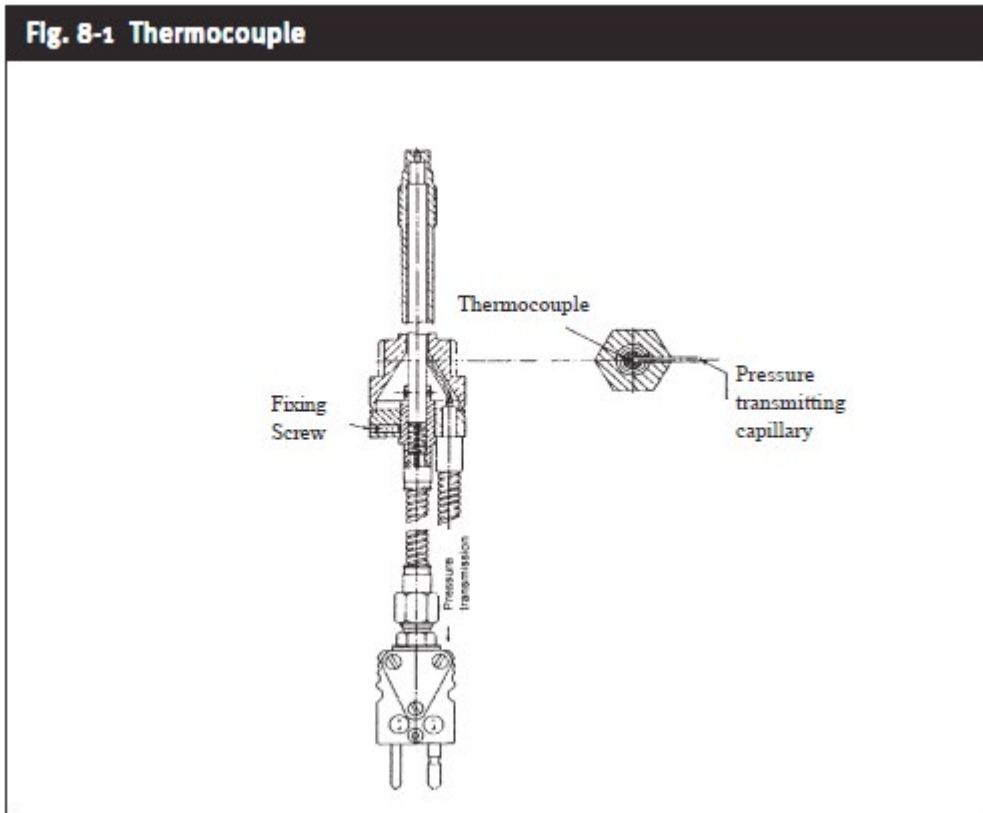

8.3 REPAIR/DISPOSAL



Toxic hazard!

The PT may contain a small amount of mercury (Hg) as its transmission medium. If the diaphragm is damaged, mercury may escape. Other configurations will contain NaK, a Sodium Potassium fill fluid, and others may contain a food grade oil. Both NaK and the food grade oil meet the requirements of the FDA and the USDA for food and medical applications.

Never transport or store the PT without the protective cap. Remove the cap shortly before installation.

If mercury or NaK is inhaled or swallowed, seek medical attention immediately!

Mercury is hazardous waste and must be disposed of in accordance with applicable laws. **DYNISCO** will accept defective PTs.



If mercury escapes, use airtight packaging!
Please send defective PTs to your **DYNISCO** representative.
For addresses, see the back cover of the operating manual.

8.4 WARRANTY

This **DYNISCO** product is warranted under terms and conditions set forth in the **DYNISCO** web pages. Go to www.dynisco.com and click “warranty” at the bottom of any page for complete details.

9. ACCESSORIES

- Machining tool kit 1/2”-20UNF-2A P/N 200295
- Cleaning tool kit 1/2”-20UNF-2A P/N 200100
- Machining tool kit M18 x1.5 P/N 200105
- Cleaning tool kit M18 x1.5 P/N 200101
- Mounting Bracket P/N 200941

10. TROUBLESHOOTING



10.1 TROUBLESHOOTING

Fault	Possible cause	Resolution
No signal	Cable breakage or poor contact No supply voltage	Check cable and contact, or replace Check supply voltage
Strong zero shift when screwing in	Mounting hole incorrectly produced (alignment error) Mounting torque too high	Check hole with test bolt, rework with tool if necessary Adjust to recommended mounting torque
No signal change despite pressure rise	Plug forming in front of diaphragm Diaphragm damaged Gas bubble in oil-filled system	Check mounting hole; remove solidified plastic, Send pressure transmitter to DYNISCO for repair, Rezero according to section 7.4

11. CE DECLARATION OF CONFORMITY



DYNISCO Europe GmbH
Wannenäckerstrasse 24
74078 Heilbronn
Germany

Tel: +49 (0) 7131.297-0
Fax: +49 (0) 7131.23260
Web: www.dynisco.com

E-Mail: DyniscoEurope@Dynisco.com



INNOVATING FOR EFFICIENCY

HERSTELLERERKLÄRUNG DECLARATION OF MANUFACTURER

im Sinne der EG – Richtlinie Druckgeräte 97/23/EG
conforming to Pressure Equipment Directive (PED) 97/23/EC

Die Drucksensoren der Typenreihen
The pressure transducer series

IDA, MDA, MDT, PT, DYNA4, TDA, TDT TPT, EMT, EIT
LDA, EPR, MRT, X1/2xxx, 8xx, S/E242/243, IPX, SPX

sind entwickelt, konstruiert und gefertigt in Übereinstimmung mit den Vorgaben der EG-
Richtlinie 97/23/EG in alleiniger Verantwortung der
are designed and produced in accordance with the requirements of PED 97/23/EC under the sole
responsibility of

Firma Dynisco Europe GmbH,
Wannenäckerstr. 24
D-74028 Heilbronn

Die oben angeführten Drucksensoren-Serien mit Druckbereich bis 1000 bar sind nach
geltender guter Ingenieurpraxis (GIP) ausgelegt und werden in Übereinstimmung mit
derselben hergestellt.
Above mentioned pressure transducers with a range up to 1000 bar/14.505 PSI are designed and produced
in accordance with Sound Engineering Practice (SEP).

Das darauf angebrachte CE-Zeichen bestätigt lediglich die Übereinstimmung mit der
Richtlinie 89/336/EG, Elektromagnetische Verträglichkeit.
The CE-mark on the transducer declares only the conformity with EC-Directive 89/336/EC, Electromagnetic
Compatibility.

Heilbronn, den 29.05.2002



Lorenz Kirberich
Marketing- und Sales Manager

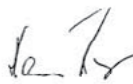

Hans Mayer
Quality Control Manager



Dynisco Instruments
38 Forge Parkway
Franklin, MA 02038
USA

Tel: +1 508 541 9400
Fax: +1 508 541 9437
Email: InfoInst@dynisco.com

Dynisco Europe GmbH
Wannenäckerstraße 24
74078 Heilbronn
Deutschland

Tel: +49 7131 2970
Fax: +49 7131 23260
Email: DyniscoEurope@dynisco.com

Dynisco Instruments S.a.r.l.
466, rue du Marché Rollay
94500 Champigny sur Marne
France

Tel: +33 1 4881 8459
Fax: +33 1 4881 8334
Email: DyniscoFrance@dynisco.com

Dynisco.s.r.l.
Via Adriatico, 2/2
20162 Milano
Italia

Tel: +39 02 661 01733
Fax: +39 02 661 02908
Email: Dyniscoltaly@dynisco.com

Dynisco UK Ltd.
Unit 2B Crowood House
Gipsy Lane
Swindon SN2 8YY
Great Britain

Tel: +44 1527 577077
Fax: +44 1527 577070
Email: DyniscoUK@dynisco.com

Dynisco SPOL, S.R.O.
cp. 579
756 55 Dolni Becva
Czech Republic

Tel: +42 0571 647228
Fax: +42 0571 647224
Email: Dyniscocz@nextra.cz