

TUC: Universal thermostat

How energy efficiency is improved

Control, monitoring and limiting according to needs and with no auxiliary energy.

Features

- Regulates and monitors the temperature of liquids in baths, containers, pipes and ducts
- Variants as temperature monitors (TW), safety temperature monitors (STW), temperature limiters (TB) or safety temperature limiters (STB)
- Thermostat with remote sensor
- Clamp-on thermostat
- Capillary tube thermostat with or without thermowell
- Double thermostat, e.g. as TW and STB
- Certified as per EN 14597 (TUC207F003 and TUC407F001, TUC407F002)
- As per PED 2014/68/EU classified as cat. IV (TUC207F003, TUC407F001 and TUC407F002)
- The shift in the change-over point is minimised due to the temperature compensation.
- Thermowell 100 mm supplied (max. 12 bar)

Technical data

Power supply			
Max. load	Terminal 1-2		230 V~, 10 (2.5) A (on the normally-closed contact)
	Terminal 1-4		230 V~, 2 (0.4) A
Min. load	Terminals 1-2, 1-4		24V =/~, 100 mA

Parameters		
Adjustment point		For t_a 22 °C
Effect of temperature at instrument head		Approx. -0.1...-0.2 K/K
Time constant with thermowell (LW 7)		< 45 s (water)
		< 60 s (oil)
Time constant without thermowell		< 120 s (air)

Ambient conditions	
Ambient temperature	0...70 °C
Storage and transport temperature	-25...80 °C
Max. Pipe temperature during fitting	120 °C

Construction	
Connection terminals	Plug-in connectors
Cable cross-section	0.75...2.5 mm ²
Sensor cartridge	Ø 6.5 mm
Housing	Two sections, lower section black, upper section yellow, including inspection window
Housing material	PA, ABS, PMMA
Weight	0.2 kg

Standards and directives	
Type of protection	IP54 (EN 60529)
Protection class	I (EN 60730)
Test marks	TÜV ID: 0000046121 (EN 14597)

Overview of types

Type	Setting range	Type	Switching difference	Capillary tube length	Sensor cartridge length (± 12 mm)	Thermowell	Max. sensor temp.
TUC101F003	-10...50 °C	TW	Approx. 4.2 K	1.6 m	80 mm	100 mm, brass	140 °C
TUC102F001	5...30 °C	TW	Approx. 5.6 K	0.7 m	65 mm	100 mm, brass	200 °C



TUC*0*F00*

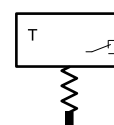

TW, STW

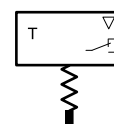

TB, STB

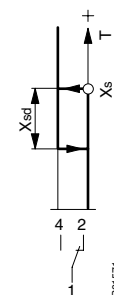

TUC407F001

TUC407F002

TUC207F003



Type	Setting range	Type	Switching difference	Capillary tube length	Sensor cartridge length (± 12 mm)	Thermowell	Max. sensor temp.
TUC105F001	15...95 °C	TW	Approx. 5.6 K	0.7 m	65 mm	100 mm, brass	200 °C
TUC106F001	40...120 °C	TW	Approx. 5.6 K	0.7 m	65 mm	100 mm, brass	200 °C
TUC107F001	50...130 °C	TW	Approx. 5.6 K	0.7 m	65 mm	100 mm, brass	200 °C
TUC108F001	80...160 °C	TW	Approx. 5.6 K	0.7 m	65 mm	100 mm, stainless steel	200 °C
TUC207F003	70...130 °C	STW	Approx. 10 K	1.6 m	60 mm	100 mm, brass	160 °C
TUC303F001	15...60 °C	TB	≤ 20 K	0.7 m	70 mm	100 mm, brass	200 °C
TUC307F001	50...130 °C	TB	≤ 20 K	0.7 m	65 mm	100 mm, brass	200 °C
TUC407F001	95...130 °C	STB	≤ 20 K	0.7 m	76 mm	100 mm, brass	160 °C
TUC407F002	95...130 °C	STB	≤ 20 K	0.7 m	76 mm	150 mm, brass	160 °C

💡 With TUC407F001, TUC407F002 and TUC207F003, only use the supplied thermowells or stainless-steel thermowells (part nos.: 0393022*** or 0392022***).

💡 TUC108 with adapter for temperature reduction, only use the supplied thermowell.

Accessories

Type	Description
0300360008	Retaining holder for cable temperature sensor or capillary tube with 0392022*** (LW 7) or LW 15 (10 pcs)
0300360009	Holder for sensor cartridge
0300360010	Retaining strap for fitting onto pipes for a pipe diameter of 15-100 mm
0300360011	Mounting plate for double thermostats
0300360012	Sensor support spiral for fitting in ventilation duct
0300360013	Duct/wall mounting bracket

Description of operation

This universal thermostat regulates and monitors the temperature of liquids or air in baths, containers, pipes and ducts.

Definitions and functions

Depending on the temperature, the single-pole change-over switch is activated.

Setpoint (X_s)

The setpoint (X_s), which can be adjusted, corresponds to the upper change-over point.

Switching difference (X_{sd})

The switching difference (X_{sd}) is equal to the difference between the upper and lower change-over point. It is set to a fixed value for all TUC models (see type description).

Temperature monitor (TW)

The temperature setpoint can only be adjusted with the aid of a tool. The set temperature is switched on and off automatically.

Safety temperature monitor (STW)

The STW has the same functions as the TW, but the contact switches to the safe side if a capillary tube is broken.

Temperature limiter (TB)

The temperature setpoint can only be adjusted with the aid of a tool. The reset is initiated by pressing the RESET button with a tool once the temperature has decreased by the minimum switching difference.

Safety temperature limiter (STB)

The STB has the same functions as the TB, but the contact switches to the safe side if a capillary tube is broken. As it is classified as PED 2014/68/EU cat. IV, the STB is suitable for safety applications.

Two universal housings can be connected to each other using accessory 0300360011. In this way, it is easy to create a monitor-limiter double thermostat.

Intended use

This product is only suitable for the purpose intended by the manufacturer, as described in the "Description of operation" section.

All related product regulations must also be adhered to. Changing or converting the product is not admissible.

Technical appendix

Switching point accuracy

TW	STW, TB, STB
At the adjustment point $\pm 6\text{K}$	At the adjustment point 0/-9 K

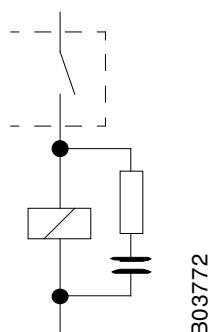

RC circuitry for inductive load

For the optimum RC circuitry, see the information from manufacturers of gates, relays, etc. If this is not available, the inductive load can be reduced by applying the following rule of thumb:

- Capacity of the RC circuitry (μF) equal to or greater than the operating current (A)
- Resistance of the RC circuitry (Ω) approx. the same as the resistance of the coil (Ω)

Materials

Material	
Housing base	PA
Housing cover	ABS
Inspection window	PMMA
Thermowell (LW 7)	Brass (CuZn) Stainless steel (CrNi)

⚠ It is the responsibility of the operating company to check and verify that the thermowell materials are compatible with the fluids in which they are submerged.

Sensor medium

Up to 160 °C	Silicone oil
--------------	--------------

Based on the available information, when used as intended, the product is not dangerous as per Directive 67/548/EEC.

Disposal

When disposing of the product, observe the currently applicable local laws. More information on materials can be found in the Declaration on materials and the environment for this product.

Connection diagram

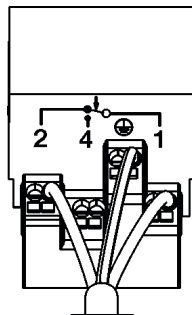

TW, STW

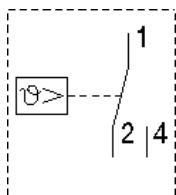

TB, STB

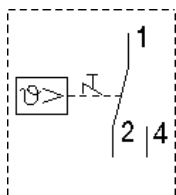

Note
Use temperature-resistant cables (T > 90 °C)

Dimension drawing

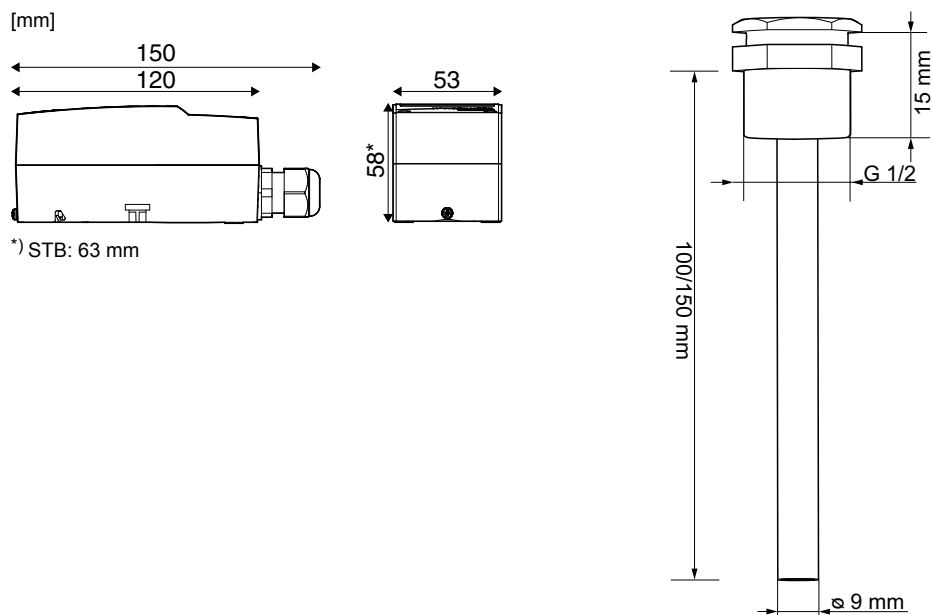

*) STB: 63 mm

Accessories

0300360011

[mm]

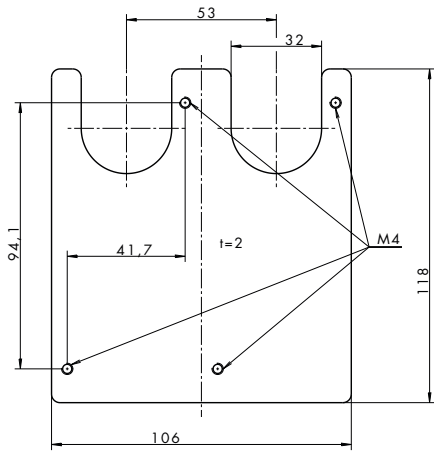

0300360012

[mm]

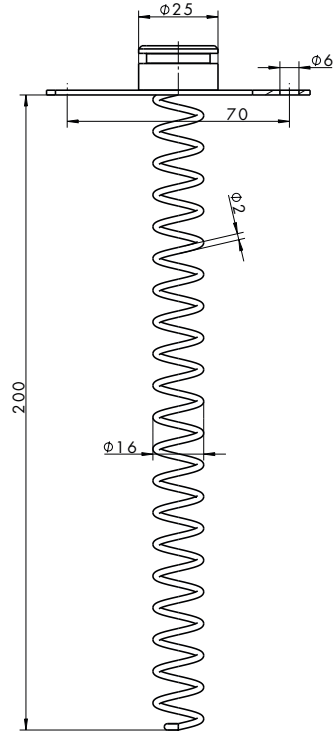

0300360013
[mm]

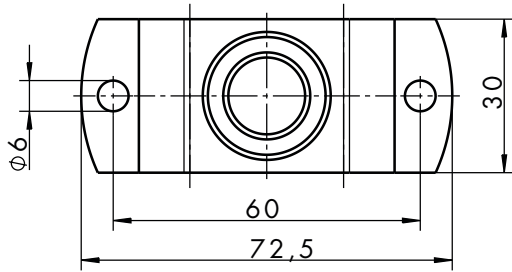
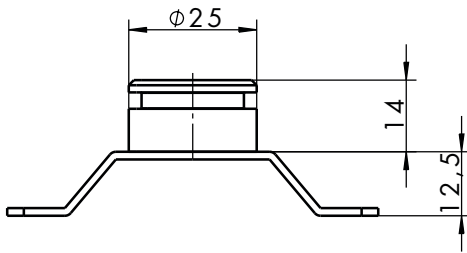

0300360009
[mm]

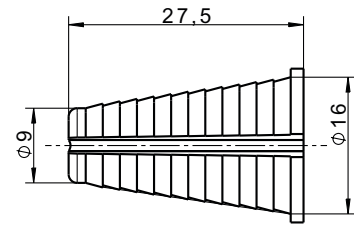
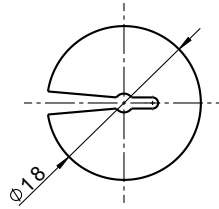

0300360008

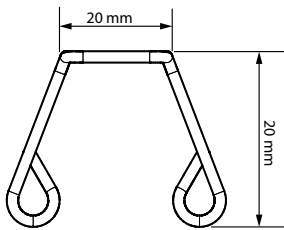

[mm]

