

Hahn Part Number: G08-19ST#27680
G 08 19 0120 1 0350 AU19 AB11 00500N

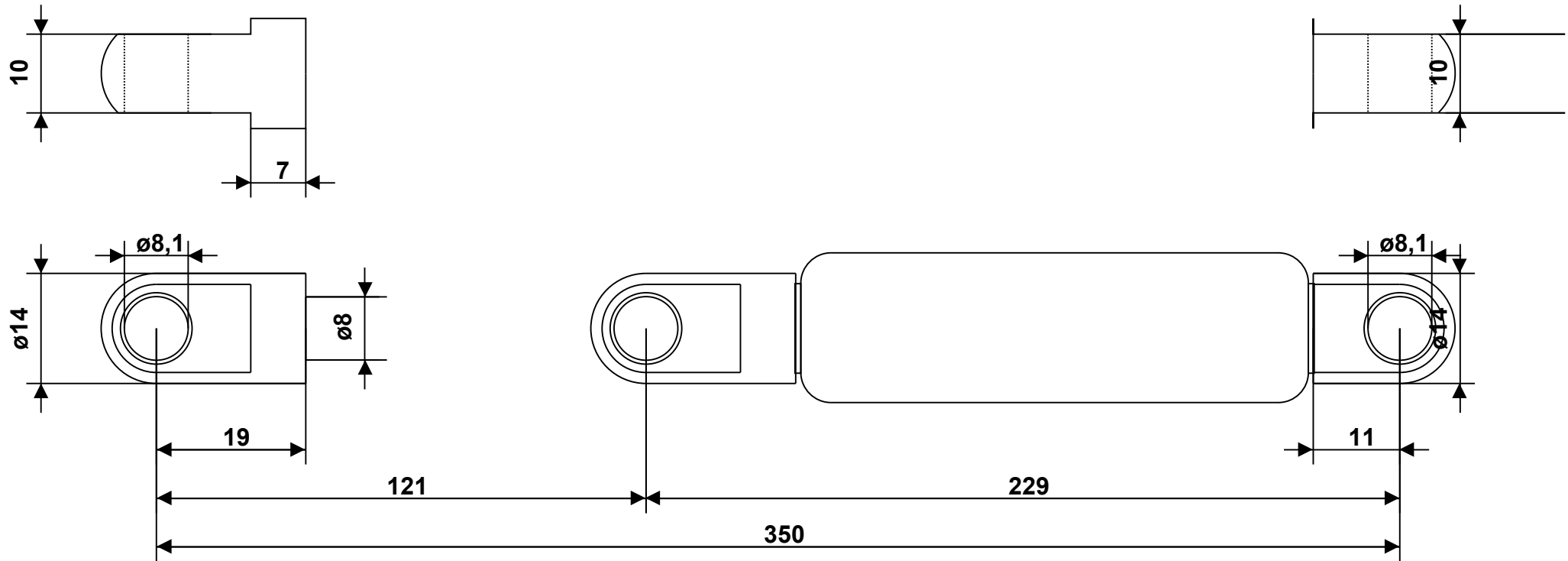

Intended for internal use and customer / Tolerance of ext. length: +/- 2mm - Dimensions without tolerance: per DIN ISO 2768-1 -c (ISO 2768 -c) - For Information Only
 Force tolerance: F1 >= 1000N: +/- 5%; < 1000N: +/- 10%, min.: +/- 10N, max.: +/- 50N - Unregistered Copy, Print-out or file not subject to modification service.
 End fitting orientation is random and not represented by drawing unless specified - Observe disposal instructions - Not true to scale



Please note our technical instructions

Assembly/storing with piston rod down

03. Mar 2020

Auto-Printservice

No opening-no heating-high pressure

Made in Germany

Part

Dimension

Material / Surface

Fitting

Progr.:27,30 %

Drawing owned by Hahn Gasfedern GmbH

Piston rod

Ø8mm

steel, chrome plated

AU19 M8 Ø8.1 t=10 * ANS/M08/AUG/001

info@hahn-gasfedern.de

Cylinder

Ø19mm

Stahl,black

AB11 Ø8,1 t=10 * BG/19/AUG/001

www.hahn-gasfedern.de

Configuration ID : 10044430-