

Monitoring Relays

1-Phase True RMS AC/DC Over or Under Voltage

Types DUB01, PUB01

CARLO GAVAZZI



DUB01



PUB01

- TRMS AC/DC over or under voltage monitoring relays
- Selection of measuring range by DIP-switches
- Measuring ranges from 0.1 to 500 V AC/DC
- Adjustable voltage on relative scale
- Adjustable hysteresis on relative scale
- Adjustable delay function (0.1 to 30 s)
- Programmable latching or inhibit at set level
- Output: 8 A SPDT relay N.D. or N.E. selectable
- For mounting on DIN-rail in accordance with DIN/EN 50 022 (DUB01) or plug-in module (PUB01)
- 22.5 mm Euronorm housing (DUB01) or 36 mm plug-in module (PUB01)
- LED indication for relay, alarm and power supply ON

Product Description

DUB01 and PUB01 are precise TRMS AC/DC over or under voltage (selectable by DIP-switch) monitoring relays. Owing to the built-in latch function, the ON-position of the relay output can be

maintained. Inhibit function can be used to avoid relay operation when not desired (maintenance, transitions). The LED's indicate the state of the alarm and the output relay.

Ordering Key

DUB 01 C B23 10V

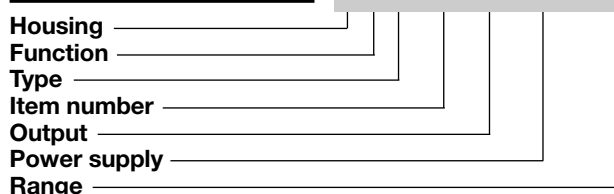

Type Selection

Mounting	Output	Measuring range	Supply: 24 to 48 VAC/DC	Supply: 115/230 VAC
DIN-rail	SPDT	0.1 to 10 V AC/DC 2 to 500 V AC/DC	DUB 01 C D48 10V DUB 01 C D48 500V	DUB 01 C B23 10V DUB 01 C B23 500V
Plug-in	SPDT	0.1 to 10 V AC/DC 2 to 500 V AC/DC	PUB 01 C D48 10V PUB 01 C D48 500V	PUB 01 C B23 10V PUB 01 C B23 500V

Input Specifications

Input (voltage level)	Terminals	Contact input	Terminals
DUB01	Terminals Y1, Y2	DUB01	Terminals Z1, Y1
PUB01	Terminals 5, 7	PUB01	Terminals 8, 9
Measuring ranges		Disabled	> 10 kΩ
Direct	Int. resist.	Enabled	< 500 Ω
Selectable by DIP-switches	Max. volt.	Latch disable	> 500 ms
..10V:			
0.1 to 1 V AC/DC	>200 kΩ		
0.2 to 2 V AC/DC	>200 kΩ		
0.5 to 5 V AC/DC	>200 kΩ		
1 to 10 V AC/DC	>200 kΩ		
Max. voltage for 1 s			
200 V			
..500V:			
2 to 20 V AC/DC	>500 kΩ		
5 to 50 V AC/DC	>500 kΩ		
20 to 200 V AC/DC	>500 kΩ		
50 to 500 V AC/DC	>500 kΩ		
Max. voltage for 1 s			
1000 V			
Note:			
The input voltage cannot raise over 300 VAC/DC with respect to ground (PUB01 only)			



Output Specifications

Output Rated insulation voltage	SPDT relay 250 VAC
Contact ratings (AgSnO ₂)	μ
Resistive loads	AC 1 8 A @ 250 VAC DC 12 5 A @ 24 VDC
Small inductive loads	AC 15 2.5 A @ 250 VAC DC 13 2.5 A @ 24 VDC
Mechanical life	≥ 30 x 10 ⁶ operations
Electrical life	≥ 10 ⁵ operations (at 8 A, 250 V, cos φ = 1)
Operating frequency	≤ 7200 operations/h
Dielectric strength	
Dielectric voltage	≥ 2 kVAC (rms)
Rated impulse withstand volt.	4 kV (1.2/50 μs)

Supply Specifications

Power supply Rated operational voltage through terminals:	Overvoltage cat. III (IEC 60664, IEC 60038)	
A1, A2 or A3, A2 (DUB01) 2, 10 or 11, 10 (PUB01)		
D48:	24 to 48 VAC/DC ± 15%	
B23:	45 to 65 Hz, insulated	
	115/230 VAC ± 15%	
	45 to 65 Hz, insulated	
Dielectric voltage	DC supply	AC supply
Supply to input	2 kV	4 kV
Supply to output	4 kV	4 kV
Input to output	4 kV	4 kV
Rated operational power		
AC	4 VA	
DC	3 W	

General Specifications

Power ON delay	1 s ± 0.5 s or 6 s ± 0.5 s
Reaction time	(input signal variation from -20% to +20% or from +20% to -20% of set value)
Alarm ON delay	< 100 ms
Alarm OFF delay	< 100 ms
Accuracy	(15 min warm-up time)
Temperature drift	± 1000 ppm/°C
Delay ON alarm	± 10% on set value ± 50 ms
Repeatability	± 0.5% on full-scale
Indication for	
Power supply ON	LED, green
Alarm ON	LED, red (flashing 2 Hz during delay time)
Output relay ON	LED, yellow
Environment	
Degree of protection	IP 20
Pollution degree	3 (DUB01), 2 (PUB01)
Operating temperature	-20 to 60°C, R.H. < 95%
Storage temperature	-30 to 80°C, R.H. < 95%
Housing	
Dimensions	DUB01 22.5 x 80 x 99.5 mm PUB01 36 x 80 x 94 mm
Material	PA66 or Noryl
Weight	Approx. 150 g
Screw terminals	
Tightening torque	Max. 0.5 Nm acc. to IEC 60947
Product standard	EN 60255-6
Approvals	UL, CSA
CE Marking	L.V. Directive 2006/95/EC EMC Directive 2004/108/EC
EMC	
Immunity	According to EN 60255-26 According to EN 61000-6-2
Emissions	According to EN 60255-26 According to EN 61000-6-3

Mode of Operation

DUB01 and PUB01 monitor both AC and DC over or under voltage.

Example 1

(no connection between terminals Z1, Y1 or 8, 9 - latch function disabled)

The relay operates when the measured value exceeds (or drops below) the set level for more than the set delay time.

It releases when the voltage

drops below (or exceeds) the set level (see hysteresis setting), or when power supply is interrupted.

Example 2

(connection between terminals Z1, Y1 or 8, 9 - latch function enabled)

The relay operates and latches in operating position when the measured value exceeds (or drops below) the set level for more than

the set delay time.

Provided that the voltage has dropped below (or has exceeded) the set point (see hysteresis setting) the relay releases when the interconnection between terminals Z1, Y1 or 8, 9 is interrupted, or power supply is interrupted as well.

The red LED flashes until the delay time has expired or the measured value has dropped below the set point (see hysteresis setting).

Note

When the inhibit contact is opened, if the input signal is already in alarm position, the delay time needs to elapse before relay activation.

Function/Range/Level and Time Delay Setting

Adjust the input range setting the DIP switches 1 and 2 as shown below.
 Select the desired function setting the DIP switches 3 to 6 as shown below.
 To access the DIP switches open the grey plastic cover as shown below.

Selection of level and time delay:

Upper knob: Setting of hysteresis on relative scale: 0 to 30% on set value.

Centre knob: Voltage level setting on relative scale: 10 to 110% on full scale.

Lower knob: Setting of delay on alarm time on absolute scale (0.1 to 30 s).

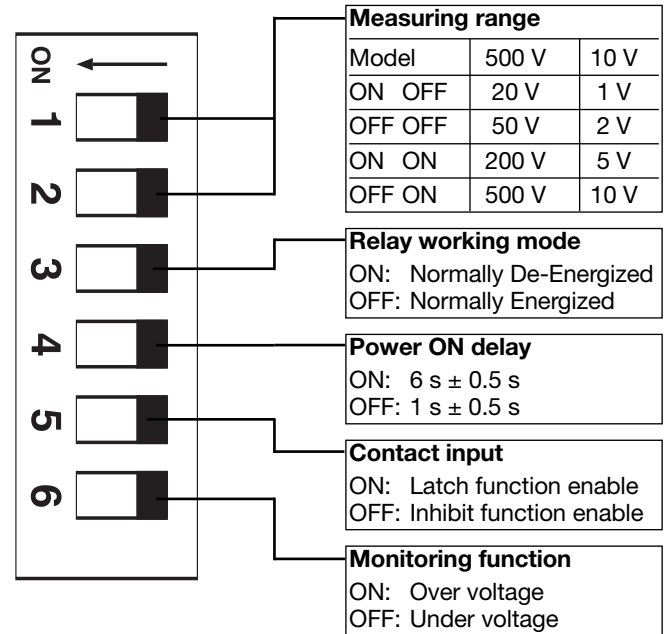
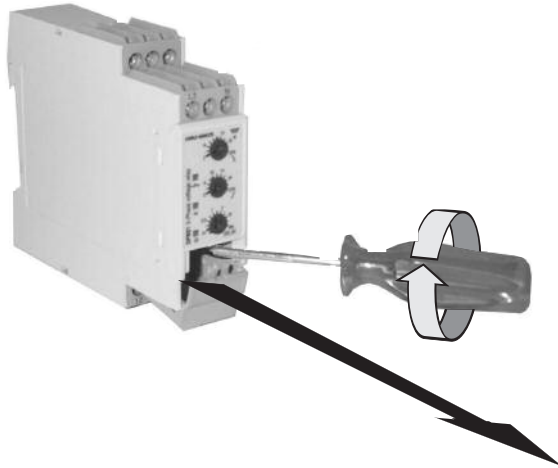

Operation Diagrams

Over voltage - N.D. relay

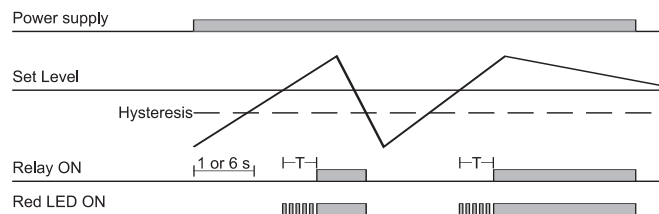

Under voltage - Latch function - N.D. relay

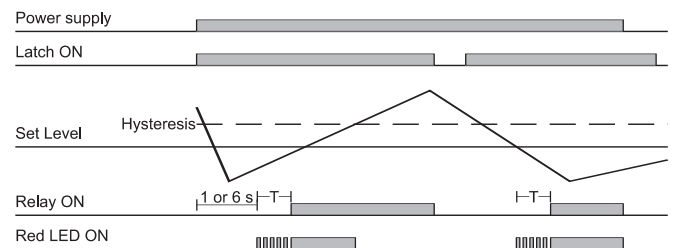

Under voltage - N.D. relay

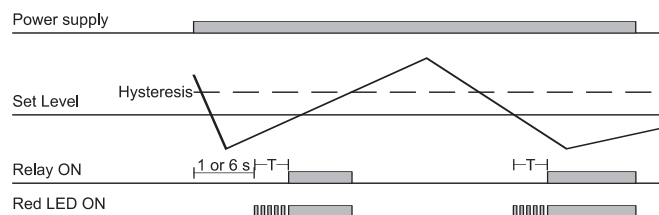

Over voltage - Inhibit function - N.D. relay

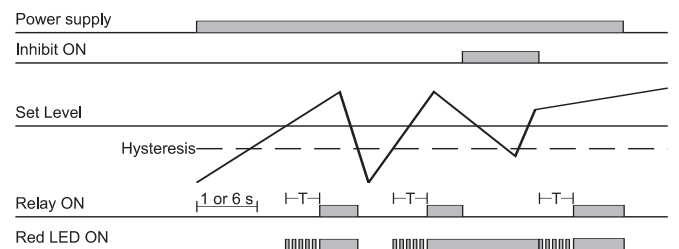

Wiring Diagrams

Example 1

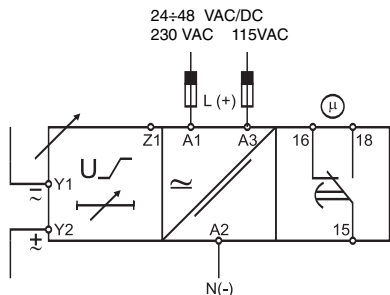

Example 2

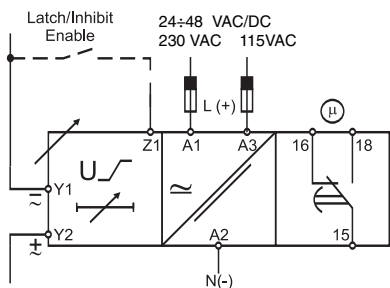

DUB01

Example 2

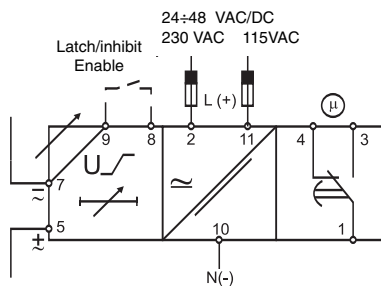
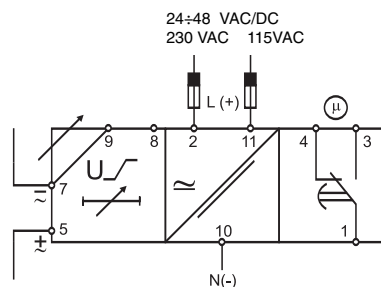

PUB01

Dimensions

DIN-rail

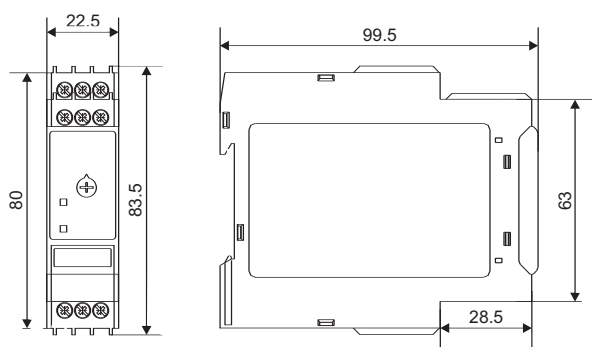

Plug-in

