

Legenda:

- A K Led VERDE
- A K Led ROSSO
- A K Resistore
- A K Diodo

FRESATURA ESTRUSO

INSERIRE FUSIBILE

EMFAI48I320/E - E4036

I2 I4 I6 I8 I10 I12 I14 I16 I18 I20 I22 I24 I26 I28 I30 I32 I34 I36 I38 I40 I42 I44 I46 I48 - +P +O1 +O2
 I1 I3 I5 I7 I9 I11 I13 I15 I17 I19 I21 I23 I25 I27 I29 I31 I33 I35 I37 I39 I41 I43 I45 I47 - +P +O1 +O2

319 mm

LED V DIODO LED R

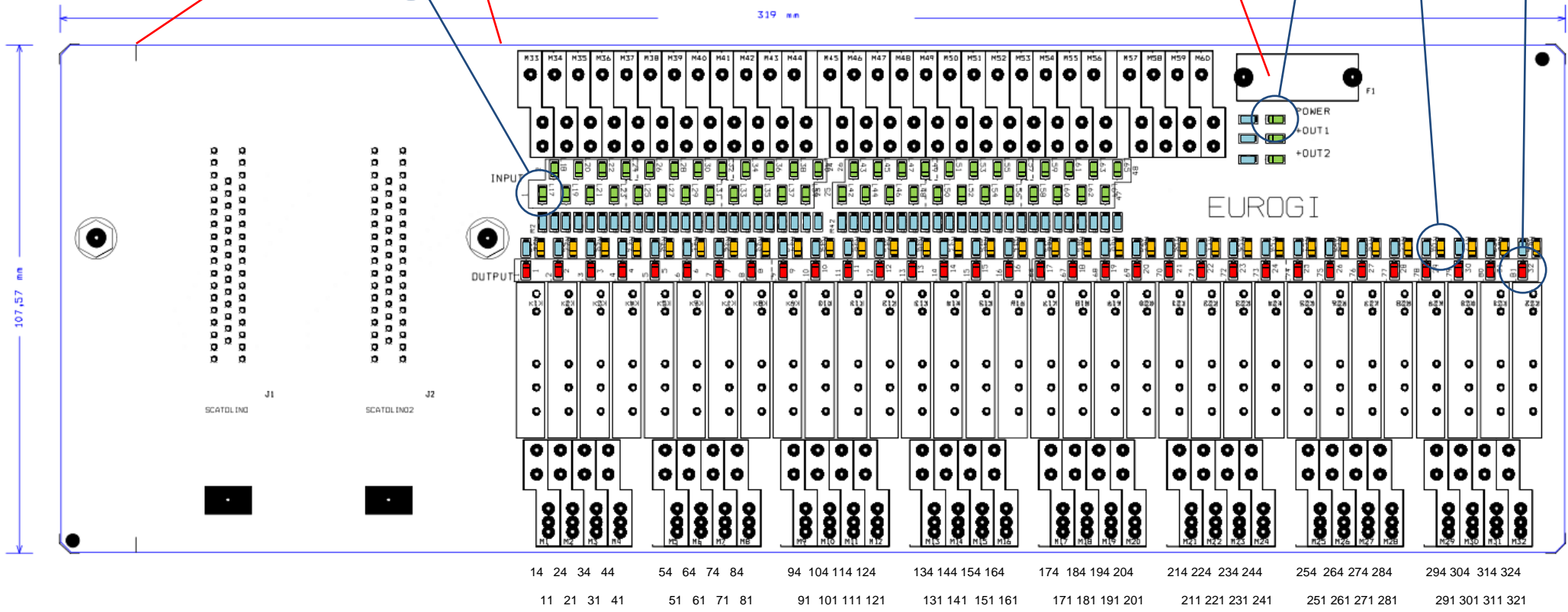
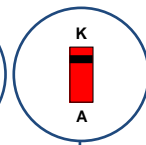
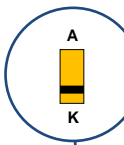
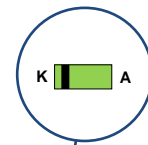
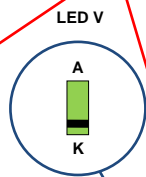

14 24 34 44 54 64 74 84 94 104 114 124 134 144 154 164 174 184 194 204 214 224 234 244 254 264 274 284 294 304 314 324
 11 21 31 41 51 61 71 81 91 101 111 121 131 141 151 161 171 181 191 201 211 221 231 241 251 261 271 281 291 301 311 321



CODICE

51E016132

SIGLA

EMFAI48I320RZ/E

REVISIONE
2

DATA
07/03/2016

Uff.
Tecnico

GB

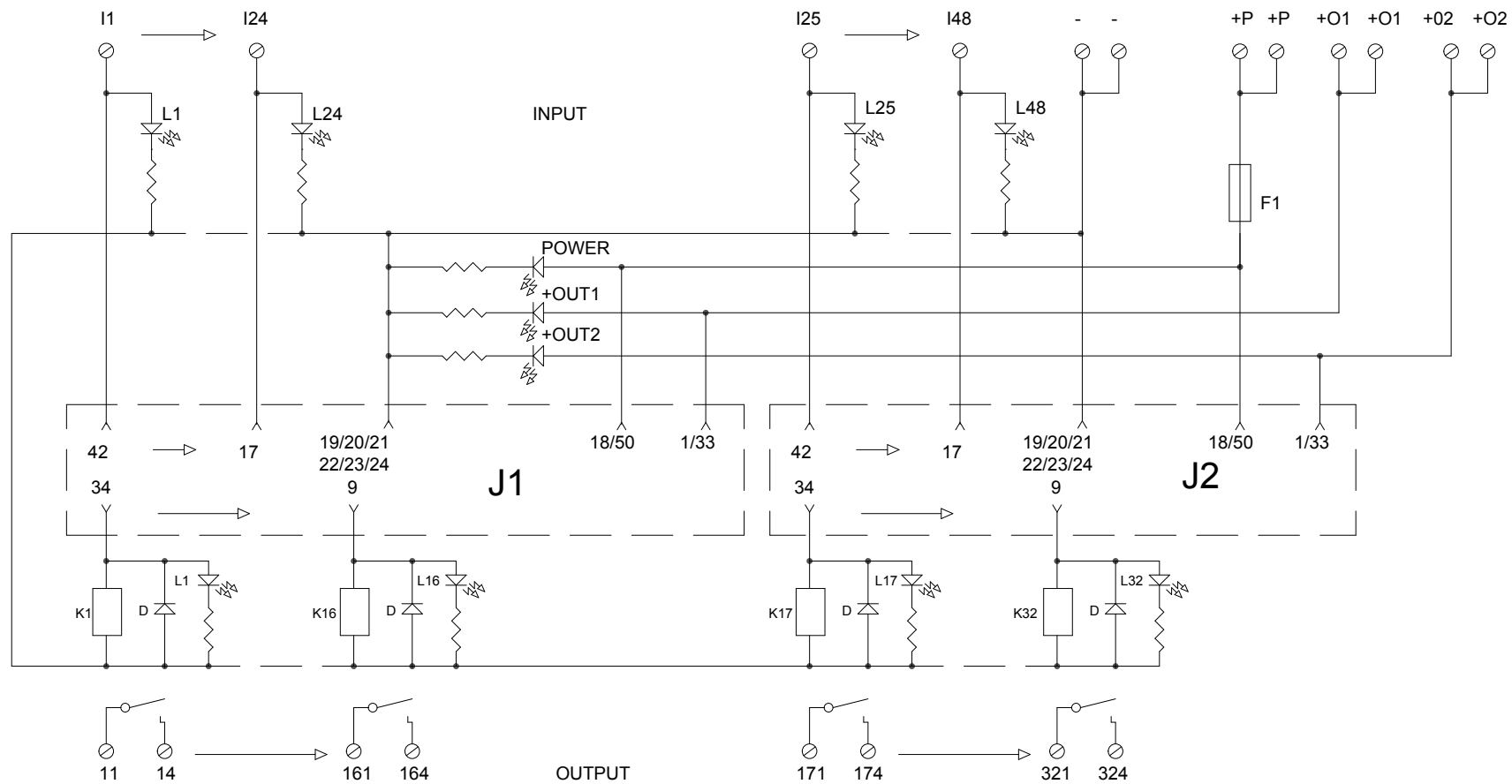

| RELE' | J1 | J2 |
|-------|----|----|
| K1 | 34 | |
| K2 | 35 | |
| K3 | 36 | |
| K4 | 37 | |
| K5 | 38 | |
| K6 | 39 | |
| K7 | 40 | |
| K8 | 41 | |
| K9 | 2 | |
| K10 | 3 | |
| K11 | 4 | |
| K12 | 5 | |
| K13 | 6 | |
| K14 | 7 | |
| K15 | 8 | |
| K16 | 9 | |

| RELE' | J1 | J2 |
|-------|----|----|
| K17 | | 34 |
| K18 | | 35 |
| K19 | | 36 |
| K20 | | 37 |
| K21 | | 38 |
| K22 | | 39 |
| K23 | | 40 |
| K24 | | 41 |
| K25 | | 2 |
| K26 | | 3 |
| K27 | | 4 |
| K28 | | 5 |
| K29 | | 6 |
| K30 | | 7 |
| K31 | | 8 |
| K32 | | 9 |

| IN | J1 | J2 |
|------|----|----|
| IN1 | 42 | |
| IN2 | 43 | |
| IN3 | 44 | |
| IN4 | 45 | |
| IN5 | 46 | |
| IN6 | 47 | |
| IN7 | 48 | |
| IN8 | 49 | |
| IN9 | 25 | |
| IN10 | 26 | |
| IN11 | 27 | |
| IN12 | 28 | |
| IN13 | 29 | |
| IN14 | 30 | |
| IN15 | 31 | |
| IN16 | 32 | |

| IN | J1 | J2 |
|------|----|----|
| IN17 | 10 | |
| IN18 | 11 | |
| IN19 | 12 | |
| IN20 | 13 | |
| IN21 | 14 | |
| IN22 | 15 | |
| IN23 | 16 | |
| IN24 | 17 | |
| IN25 | | 42 |
| IN26 | | 43 |
| IN27 | | 44 |
| IN28 | | 45 |
| IN29 | | 46 |
| IN30 | | 47 |
| IN31 | | 48 |
| IN32 | | 49 |

| IN | J1 | J2 |
|------|----|----|
| IN33 | | 25 |
| IN34 | | 26 |
| IN35 | | 27 |
| IN36 | | 28 |
| IN37 | | 29 |
| IN38 | | 30 |
| IN39 | | 31 |
| IN40 | | 32 |
| IN41 | | 10 |
| IN42 | | 11 |
| IN43 | | 12 |
| IN44 | | 13 |
| IN45 | | 14 |
| IN46 | | 15 |
| IN47 | | 16 |
| IN48 | | 17 |

| Segn. | J1 | J2 |
|-------|----|----|
| +OUT | 1 | 1 |
| | 33 | 33 |
| +24V | 18 | 18 |
| | 50 | 50 |
| 0V | 19 | 19 |
| | 20 | 20 |
| | 21 | 21 |
| | 22 | 22 |
| | 23 | 23 |
| | 24 | 24 |

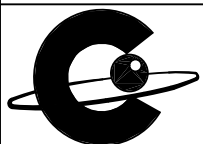

CODICE

51E016132

SIGLA

EMFAI48I32ORZ/E

REVISIONE

1

DATA
29/07/2015

Uff. Tecnico

GB