

PRODUCTS GUIDE



www.mak.nl

P.O. box 462
8200 AL Lelystad
The Netherlands

T +31 (0)320 - 266966
F +31 (0)320 - 266999



MEGADYNE

Megadyne worldwide presence	3	MEGARIB PU endless ribbed belts	33
ISORAN Rubber endless timing belts	7	MEGAFLAT PU and Rubber endless flat belts	35
ISORAN OPEN-END Rubber timing belt rolls	13	MEGAPOWER PU endless timing belts	37
EXTRA - OLEOSTATIC - OLEOSTATIC GOLD ESAFLEX - XDV2 - PLURIBAND - CONTRAFOR Rubber wrapped V-Belts	15	MEGALINEAR PU open-end timing belts	41
ACCU-LINK Urethane adjustable V-Belts	25	MEGAFLEX PU truly endless timing belts	45
LINEA-X - LINEA GOLD Rubber raw edge V-Belts	26	SPECIAL PRODUCTS Special Covers, Cleats, Special Reworking	49
PV Rubber ribbed belts	31	METAL Pulleys, timing bars, taper bushes and clamping plates	55
		MEGAWELD Thermoweldable belts	59
		Accessories	60

ABOUT US



Megadyne operates in the sector of power transmission since the middle of 1900's, when Corrado Tadolini, a young mechanical engineer began the production of flat transmission belts in Mathi, next to its current location.

Since then, through:

- the support of numerous and capable staff able to offer invaluable technical input, as well as considerable professional and human qualities;
- the contribution of partners that joined the group such as Jason Industrial with 50 years of experience in the U.S. market and Rultrans for more than 30 years in the conveyor belts market;
- the internationalization of the business through the birth and growth of 10 production units located in Europe, North America and Asia, as well as 30 sales offices to guarantee the best service to our customers all over the world;
- continuous investments aimed at ensuring the quality of products and services, an unrivaled capacity for research and development of innovative products to meet and even anticipate market requirements in various industries, careful management of production processes;

the Megadyne Group has consistently grown to establish itself as a leader in its field.

It is our intention to continue to support and reinforce this leadership position through a product offering that meets and possibly exceeds market expectations.

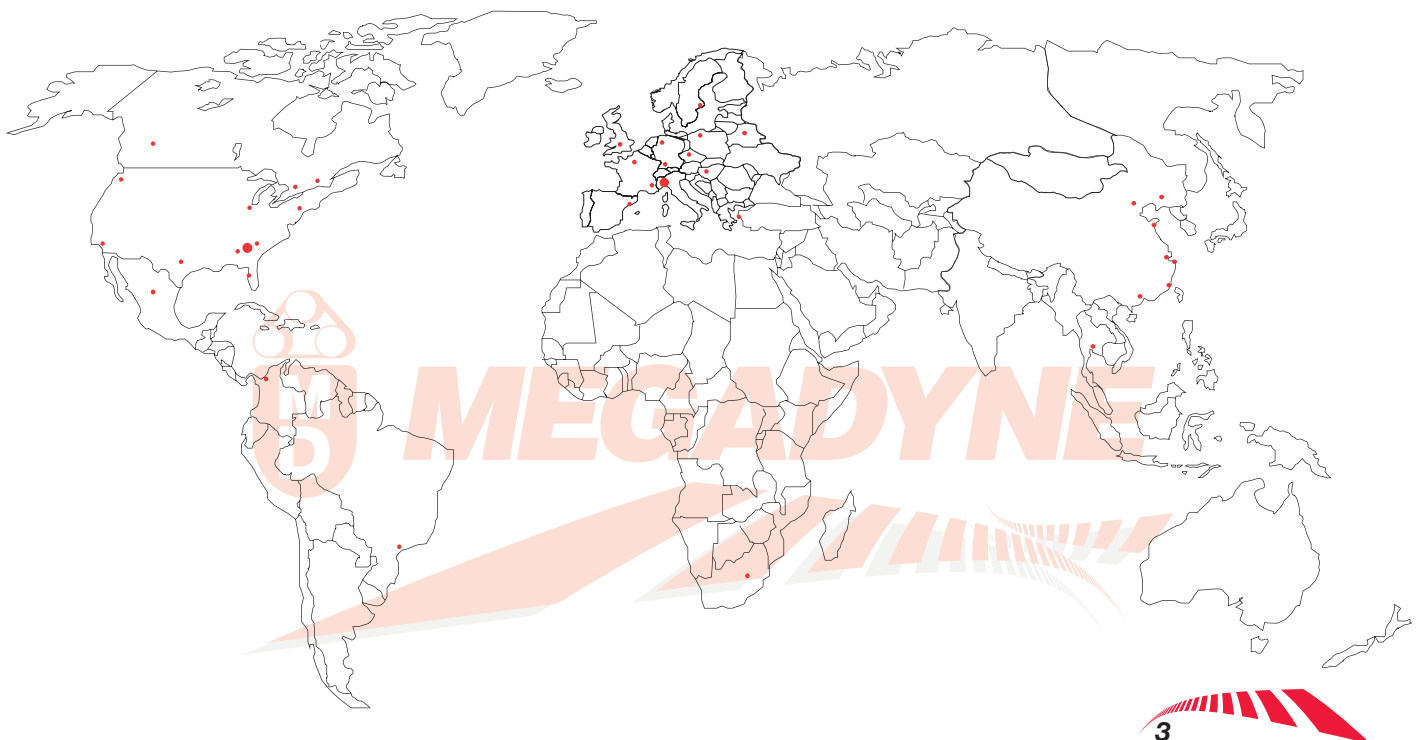

MEGADYNE WORLDWIDE PRESENCE

EUROPE PRODUCTION CENTERS



HEADQUARTERS - MATHI - TORINO - ITALY



ELCHINGEN - GERMANY



VILANOVA - BARCELONA - SPAIN



ST. JEAN DE MAURIENNE - FRANCE



BYDGOSZCZ - POLAND



IZMIR - TURKEY

EUROPE DISTRIBUTION CENTERS

- MEGADYNE S.p.A. - Torino - ITALY
- MEGADYNE FRANCE - Bondoufle - FRANCE
- MEGADYNE GmbH - Borchten - GERMANY
- MEGADYNE Rubber - Barcelona - SPAIN
- MEGADYNE UK - Dudley - UK
- MEGADYNE HU - Budapest - HUNGARY
- MEGADYNE EE - Minsk - BELARUS
- MEGADYNE CZ - Prague - CZECH REPUBLIC
- MEGADYNE NORDIC - Sollentuna - SWEDEN
- MEGADYNE PP. SP.ZO.O. - Bydgoszcz - POLAND
- MEGADYNE TURKEY - Izmir - TURKEY
- MEGADYNE S.A - Johannesburg - SOUTH AFRICA

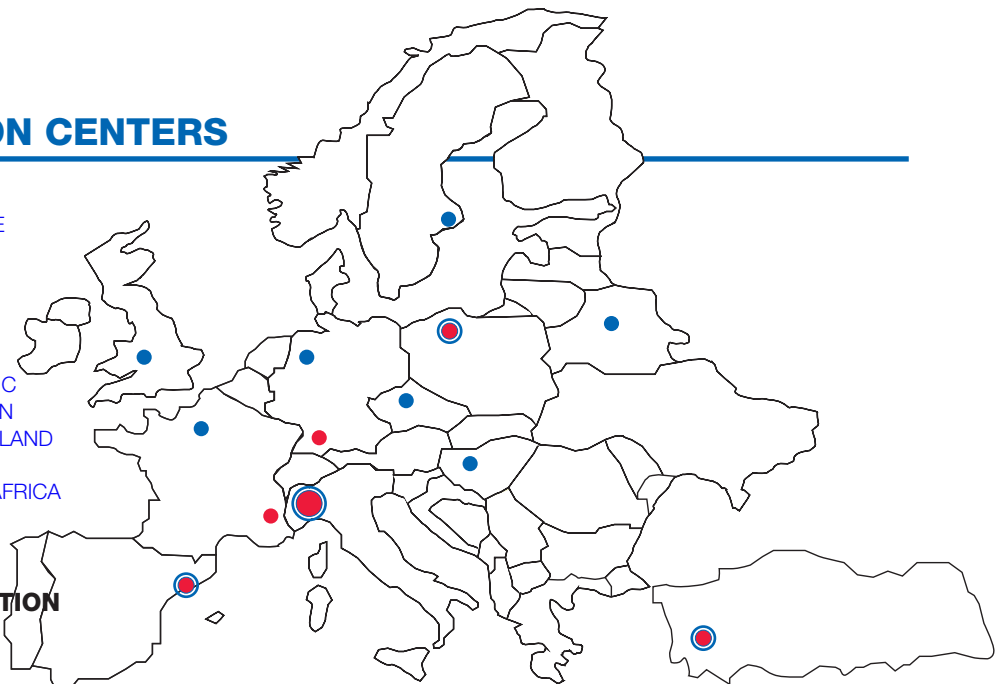

-  **DISTRIBUTION AND PRODUCTION**
-  **PRODUCTION CENTERS**
-  **DISTRIBUTION CENTERS**

MEGADYNE WORLDWIDE PRESENCE

AMERICAS PRODUCTION CENTERS

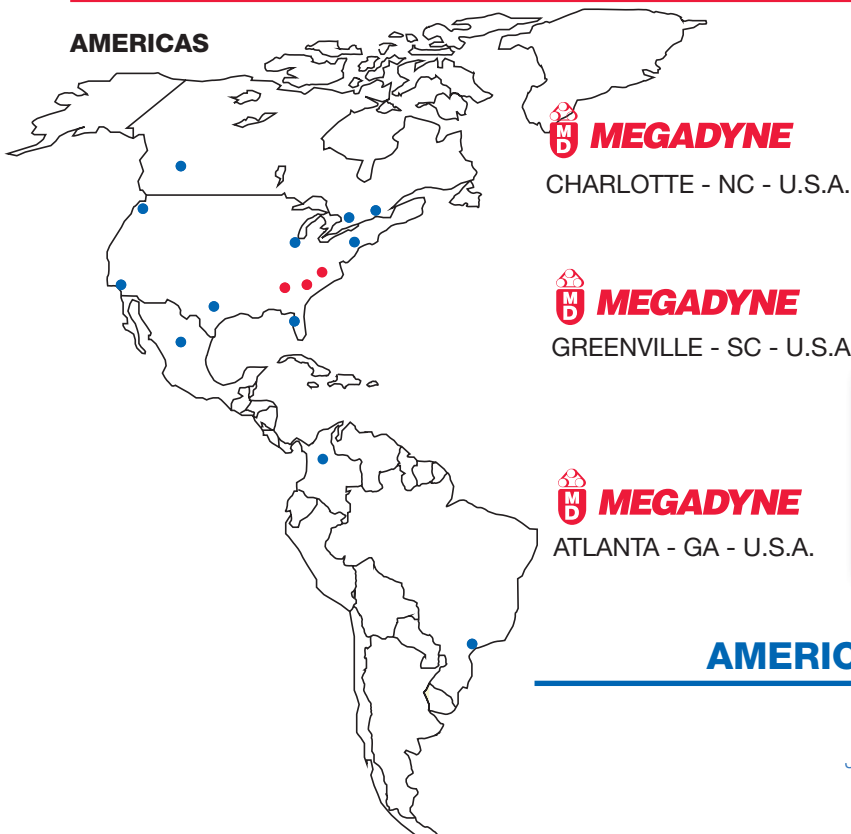

AMERICAS



CHARLOTTE - NC - U.S.A.



GREENVILLE - SC - U.S.A.



ATLANTA - GA - U.S.A.



- DISTRIBUTION AND PRODUCTION CENTER
- PRODUCTION CENTERS
- DISTRIBUTION CENTERS

AMERICAS DISTRIBUTION CENTERS

- JASON INDUSTRIAL INC. - Fairfield - NJ - USA
- JASON DISTRUBUTION CENTER - Carol Stream - IL - USA
- JASON INDUSTRIAL INC. - Dallas - TX - USA
- JASON INDUSTRIAL INC. - Los Angeles - CA - USA
- JASON INDUSTRIAL INC. - Portland - OR - USA
- JASON INDUSTRIAL INC. - Tampa - FL - USA
- JASON INDUSTRIAL CANADA - Toronto - Ontario - CANADA
- JASON INDUSTRIAL CANADA - Montreal - Quebeq - CANADA
- JASON INDUSTRIAL CANADA - Alberta - Edmonton - CANADA
- JASON INDUSTRIAL S.DER.L.DEC.V - Azcapotzalco - MEXICO
- JASON COMMERCIAL Ltda. - Sao Paulo - BRAZIL
- JASON - Cartagena - COLOMBIA

ASIA & PACIFIC PRODUCTION CENTERS



QINGDAO - CHINA



NINGBO - CHINA

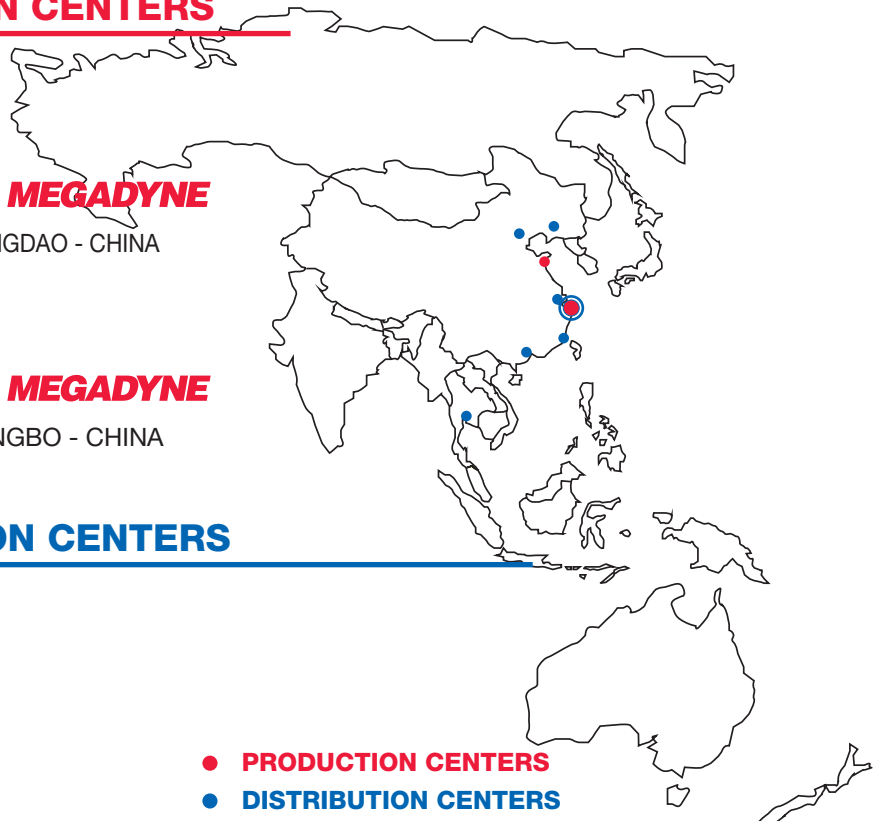

ASIA & PACIFIC DISTRIBUTION CENTERS

- MEGADYNE - Shenyang - P.R.C.
- MEGADYNE - Beijing - P.R.C.
- MEGADYNE - Shanghai - P.R.C.
- MEGADYNE - Fujiang - P.R.C.
- MEGADYNE - Foshan - P.R.C.
- MEGADYNE - Ningbo - P.R.C.
- MEGADYNE - Quingdao - P.R.C.
- MEGADYNE THAILAND - Bangkok - THAILAND

- PRODUCTION CENTERS
- DISTRIBUTION CENTERS

MEGADYNE WORLDWIDE PRESENCE



Jason Industrial offers a complete range of industrial V-belts, neoprene and urethane synchronous belts, each provided in all imperial and metric cross-sections or pitches.

Jason, built on customer service, is available to assist customer with its team of well-trained sales professionals and engineers, backed by domestic manufacturing facilities for all synchronous belt products. Jason/Megadyne factories are world-class facilities, which manufacture to industry standard specifications.

Jason is not limited to the U.S.A., it has replicated its domestic business practices with sales/distribution centers in Canada, Mexico, and Brazil, where it provides single source solutions, a brand new distribution center was recently established in Central America.



Rultrans, which was established in Izmir to import power transmission belts and distribute around Turkey has been carrying on its activities in Kemalpaşa Organized Industrial Zone since 1998.

In 2005, in accordance with sustainable growth purpose, Rultrans started PVC/PU conveyor belts production in its facilities equipped with state-of-the art technology. Rultrans, selling conveyor belts in full rolls and cut to order pieces; aims to serve its customers with wide variety of products and ready-wear, on site installation, quick return and price advantages.

Rultrans continues to cooperate with the leading companies for transmission belt world wide and is the leader in the domestic market. Conveyor belts produced in Kemalpaşa facilities are exported to about 50 countries, in five different continents. Rultrans, creates a significant difference for its customers by its logistics advantage as in geographical position.

Rultrans carrying on its operations via contact offices in Corlu and Bursa and region directorates in Izmir, Istanbul and Adana continues export operations in coordination with group companies. RULTRANS provides effective solutions to the customers since 1981 with its own production conveyor belts and a full range of power transmission belts.

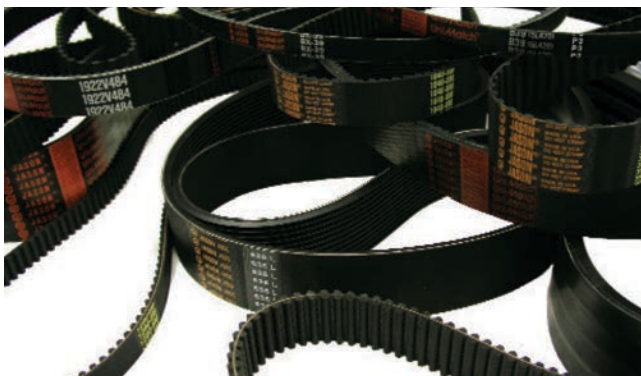

ISORAN
Rubber endless timing belts

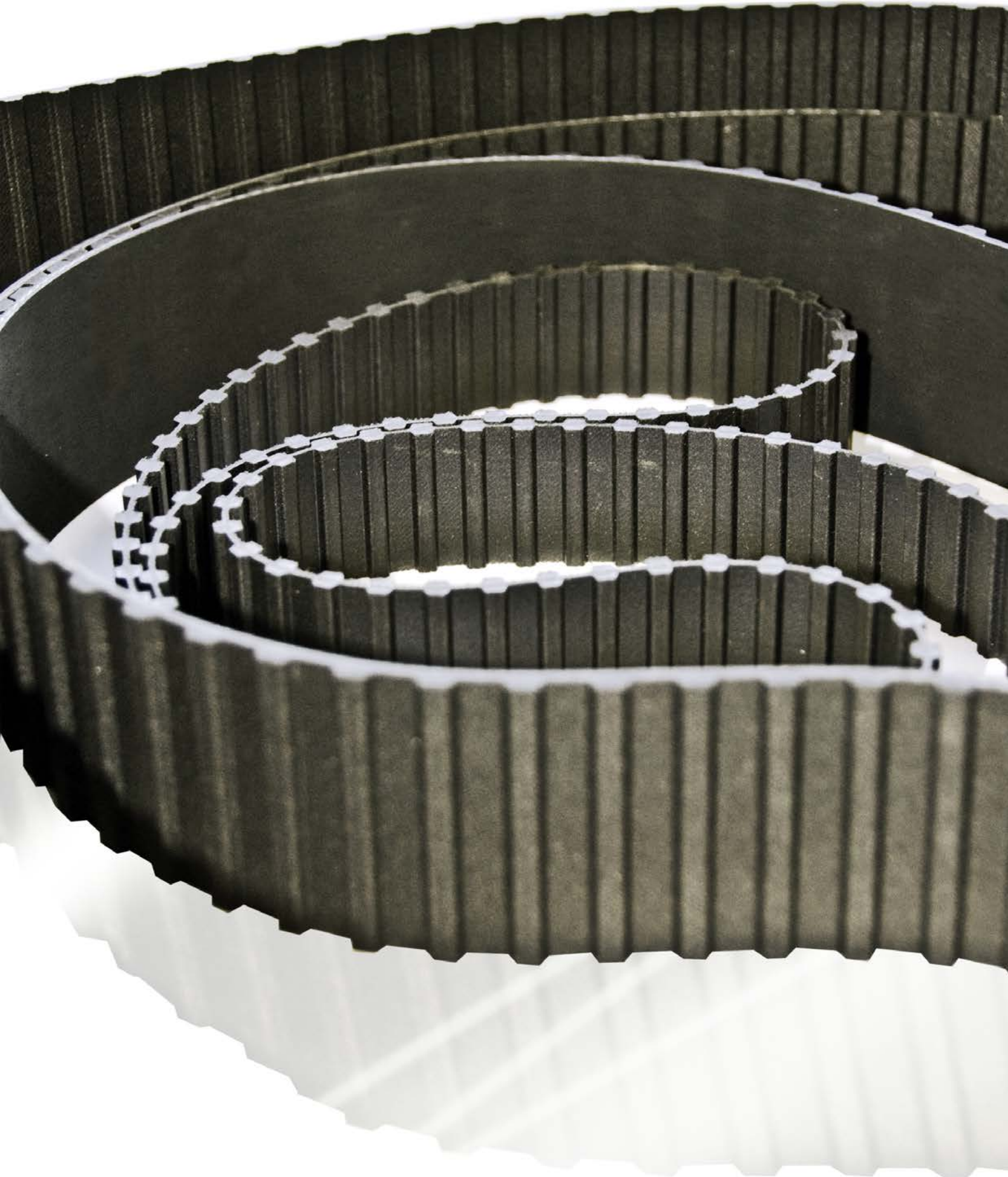

ISORAN

Rubber endless timing belts



MEGADYNE RUBBER timing belts are available with single or double sided teeth, in imperial and RPP profiles. They are manufactured using the most advanced technology available.

ISORAN IMPERIAL SYNCHRONOUS MXL XL L H XH XXH

- Trapezoidal tooth profile
- Polychloroprene teeth for accurate meshing
- Fiberglass reinforcement for minimal elongation
- Nylon fabric protecting tooth surface

ISORAN RPP3 RPP5 RPP8 RPP14 RPP20

- RPP parabolic tooth profile gives graduated pressure increase over tooth height
- Fiberglass reinforcement for minimal elongation and high flexibility
- Chloroprene rubber for wear resistance and increased service life
- Nylon fabric protecting tooth surface, with self lubrication



RPP SILVER and **RPP GOLD** are constructed with the highest quality materials.

The bonded strength of all components guarantees superior torque capacity. The ISORAN RPP SILVER increases load carrying capacity up to 10% compared to previous RPP Plus, while the ISORAN RPP GOLD increases up to 30%.

ISORAN RPP SILVER and RPP GOLD advantages:

- Upgrade the existing transmission without changing the pulleys
- Perfect interchangeability with parabolic and deep pulley profile
- Antistatic Properties conforming to the BS 2050
- Drive energy efficiency up to 98%
- Excellent for backside idlers
- Higher tooth jump resistance
- Increased resistance to tooth shear
- Quiet, maintenance-free operation

ISORAN PLATINUM is a rubber based timing belt, which solves the problems related to steel and aramide cords, thanks to the development and usage of its innovative “Dual Core” hybrid cord technology. PLATINUM reaches the highest level of performances incorporating this cord in a new rubber matrix and covering the teeth with a special and unique heavy fabric. Thanks to the innovative materials used, PLATINUM:

- Increased basic power capacity by up to 40% compared to the current RPP GOLD;
- Use of existing RPP pulleys, maintaining a full functional interchange with other deep pulley profile systems, like HTD, etc.
- Allows existing drives to be upgraded without the necessity to replace the pulleys, just the belt itself.
- Reduction of noise by reduced belt widths due to the higher performance rating of the system. Under the same transmission conditions, PLATINUM has the same noise level of RPP GOLD;
- Low noise characteristics compared to drive systems using polyurethane, steel etc. due to the rubber matrix and its teeth with the parabolic profile shape, recognized as the quietest system on the market
- A wide, continuous range of possible operating temperature, like no other system, which makes PLATINUM the only solution for extreme working conditions.



ISORAN Rubber endless timing belts

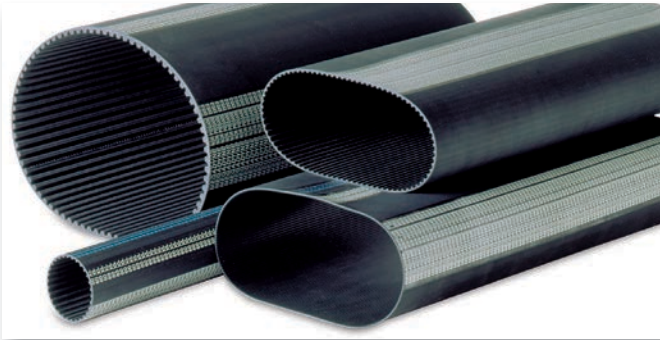

ISORAN IMPERIAL
MXL - XL - L - H - XH - XXH
XLDD - LDD - HDD



ISORAN RPP
RPP3 - RPP5 - RPP8 - RPP14 - RPP20
RPP5DD - RPP8DD - RPP14DD



ISORAN RPP SILVER
SLV5 - SLV8 - SLV14 - SLV8 DD - SLV14 DD



ISORAN RPP GOLD
GOLD8 - GOLD14



ISORAN RPP PLATINUM
PLT8 - PLT14

ISORAN

Rubber endless timing belts

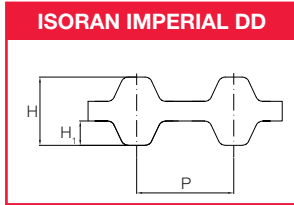
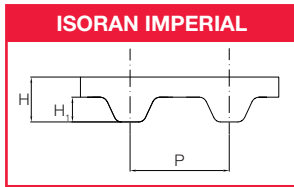

MXL	
Code	Pitch length (mm)
360 MXL	91,44
432 MXL	109,73
440 MXL	111,76
456 MXL	115,82
480 MXL	121,92
488 MXL	123,95
496 MXL	125,98
536 MXL	136,14
544 MXL	138,18
576 MXL	146,30
584 MXL	148,34
608 MXL	154,43
632 MXL	160,53
640 MXL	162,56
656 MXL	166,62
664 MXL	168,66
680 MXL	172,72
704 MXL	178,82
720 MXL	182,88
736 MXL	186,94
752 MXL	191,00
760 MXL	193,04
776 MXL	197,10
800 MXL	203,20
808 MXL	205,23
824 MXL	209,30
840 MXL	213,36
880 MXL	223,52
888 MXL	225,55
912 MXL	231,65
920 MXL	233,68
944 MXL	239,78
952 MXL	241,81
960 MXL	243,84
976 MXL	247,90
984 MXL	249,94
1000 MXL	254,00
1008 MXL	256,03
1016 MXL	258,06
1040 MXL	264,16
1056 MXL	268,22
1072 MXL	272,29
1120 MXL	284,48
1160 MXL	294,64
1176 MXL	298,70
1184 MXL	300,74
1200 MXL	304,80
1224 MXL	310,90
1280 MXL	325,12
1400 MXL	355,60
1472 MXL	373,89
1496 MXL	379,98
1520 MXL	386,08
1600 MXL	406,40
1680 MXL	426,72
1696 MXL	430,78
1768 MXL	449,07
1800 MXL	457,20
1832 MXL	465,33
1856 MXL	471,42
1888 MXL	479,55
1984 MXL	503,94
1992 MXL	505,97
2048 MXL	520,19
2240 MXL	568,96
2360 MXL	599,44
2384 MXL	605,54
2480 MXL	629,92
2496 MXL	633,98
2520 MXL	640,08
2584 MXL	656,34
2776 MXL	705,10
2864 MXL	727,46
2880 MXL	731,52
2976 MXL	755,90
3064 MXL	778,26
3104 MXL	788,42
3200 MXL	812,80
3296 MXL	837,18
3424 MXL	869,70
3472 MXL	881,89
3480 MXL	883,92
3520 MXL	894,08
3632 MXL	922,53
3704 MXL	940,82
3944 MXL	1001,78
4000 MXL	1016,00
4064 MXL	1032,26
4200 MXL	1066,80
4280 MXL	1087,12
P	2,032
H₁	0,51
H	1,14

MXL	
Code	Pitch length (mm)
4320 MXL	1097,28
4456 MXL	1131,82
4736 MXL	1202,94
4800 MXL	1219,20
5224 MXL	1326,90
P	2,032
H₁	0,51
H	1,14

XL	
Code	Pitch length (mm)
54 XL	137,16
60 XL	152,40
70 XL	177,80
80 XL	203,20
90 XL	228,60
98 XL	248,92
100 XL	254,00
102 XL	259,08
104 XL	264,16
106 XL	269,24
110 XL	279,40
120 XL	304,80
130 XL	330,20
140 XL	355,60
146 XL	370,84
150 XL	381,00
156 XL	396,24
160 XL	406,40
170 XL	431,80
176 XL	447,04
180 XL	457,20
182 XL	462,28
188 XL	477,52
190 XL	482,60
198 XL	502,92
200 XL	508,00
202 XL	513,08
210 XL	533,40
212 XL	538,48
214 XL	543,56
220 XL	558,80
228 XL	579,12
230 XL	584,20
234 XL	594,36
240 XL	609,60
250 XL	635,00
260 XL	660,40
270 XL	685,80
276 XL	701,04
290 XL	736,60
310 XL	787,40
316 XL	802,64
320 XL	812,80
330 XL	838,20
344 XL	873,76
352 XL	894,08
364 XL	924,56
380 XL	965,20
384 XL	975,36
388 XL	985,52
390 XL	990,60
392 XL	995,68
434 XL	1102,36
460 XL	1168,40
530 XL	1346,20
600 XL	1524,00
710 XL	1803,40
P	5,08
H₁	1,27
H	2,4

L	
Code	Pitch length (mm)
124 L	314,96
135 L	342,90
150 L	381,00
173 L	439,42
187 L	476,25
202 L	513,80
210 L	533,40
225 L	571,50
240 L	609,60
255 L	647,70
270 L	685,80
285 L	723,90
300 L	762,00
322 L	819,15
334 L	848,36
345 L	876,30
367 L	933,45
390 L	990,60
405 L	1028,70
412 L	1047,75
420 L	1066,80
450 L	1143,00
480 L	1219,20
510 L	1295,40
540 L	1371,60
600 L	1524,00
728 L	1847,85
817 L	2076,45
P	9,525
H₁	1,91
H	3,6

XL DD	
Code	Pitch length (mm)
120 XL DD	304,80
130 XL DD	330,20
140 XL DD	355,60
146 XL DD	370,84
150 XL DD	381,00
156 XL DD	396,24
160 XL DD	406,40
170 XL DD	431,80
176 XL DD	447,04
180 XL DD	457,20
182 XL DD	462,28
188 XL DD	477,52
190 XL DD	482,60
198 XL DD	502,92
200 XL DD	508,00
202 XL DD	513,08
210 XL DD	533,40
212 XL DD	538,48
214 XL DD	543,56
220 XL DD	558,80
228 XL DD	579,12
230 XL DD	584,20
234 XL DD	594,36
240 XL DD	609,60
250 XL DD	635,00
260 XL DD	660,40
270 XL DD	685,80
276 XL DD	701,04
290 XL DD	736,60
310 XL DD	787,40
316 XL DD	802,64
320 XL DD	812,80
330 XL DD	838,20
344 XL DD	873,76
352 XL DD	894,08
364 XL DD	924,56
380 XL DD	965,20
384 XL DD	975,36
388 XL DD	985,52
390 XL DD	990,60
392 XL DD	995,68
434 XL DD	1102,36
460 XL DD	1168,40
530 XL DD	1346,20
600 XL DD	1524,00
710 XL DD	1803,40
P	5,08
H₁	1,27
H	3,05

H	
Code	Pitch length (mm)
240 H	609,60
270 H	685,80
300 H	762,00
330 H	838,00
360 H	914,40
390 H	990,60
420 H	1066,80
450 H	1143,00
480 H	1219,20
510 H	1295,40
540 H	1371,60
570 H	1447,80
600 H	1524,00
630 H	1600,20
660 H	1676,40
670 H	1701,80
700 H	1778,00
725 H	1841,50
750 H	1905,00
800 H	2032,00
850 H	2159,00
900 H	2286,00
1000 H	2540,00
1100 H	2794,00
1120 H	2844,80
1140 H	2895,60
1150 H	2921,00
1250 H	3175,00
1400 H	3556,00
1645 H	4178,30
1700 H	4318,00
P	12,7
H₁	2,29
H	4,4

L DD	
Code	Pitch length (mm)
124 L DD	314,96
135 L DD	342,90
150 L DD	381,00
173 L DD	439,42
187 L DD	474,98
202 L DD	513,80
210 L DD	533,40
225 L DD	571,50
240 L DD	609,60
255 L DD	647,70
270 L DD	685,80
285 L DD	723,90
300 L DD	762,00
322 L DD	817,88
334 L DD	848,36
345 L DD	876,30
367 L DD	932,18
390 L DD	990,60
405 L DD	1028,70
412 L DD	1046,48
420 L DD	1066,80
450 L DD	1143,00
480 L DD	1219,20
510 L DD	1295,40
540 L DD	1371,60
600 L DD	1524,00
728 L DD	1849,12
817 L DD	2075,18
P	9,525
H₁	1,91
H	4,6

XH	
Code	Pitch length (mm)
507 XH	1289,00
534 XH	1356,36
560 XH	1422,40
600 XH	1600,20
700 XH	1778,00
770 XH	1955,80
840 XH	2133,60
980 XH	2489,20
1120 XH	2844,80
1260 XH	3200,40
1400 XH	3566,00
1540 XH	3911,60
1750 XH	4445,00
P	22,225
H₁	6,22
H	11,4

XXH	
Code	Pitch length (mm)
700 XXH	1778,00
800 XXH	2032,00
900 XXH	2286,00
1000 XXH	2540,00
1200 XXH	3048,00
1400 XXH	3556,00
1600 XXH	4064,00
1800 XXH	4572,00
P	31,75
H₁	9,53
H	15,3

H DD	
Code	Pitch length (mm)
240 H DD	609,60
270 H DD	685,80
300 H DD	762,00
330 H DD	838,20
360 H DD	914,40
390 H DD	990,60
420 H DD	1066,80
450 H DD	1143,00
480 H DD	1219,20
510 H DD	1295,40
540 H DD	1371,60
570 H DD	1447,80
600 H DD	1524,00
630 H DD	1600,20
660 H DD	1676,40
670 H DD	1701,80
700 H DD	1778,00
725 H DD	1841,50
750 H DD	1905,00
800 H DD	2032,00
850 H DD	2159,00
900 H DD	2286,00
1000 H DD	2540,00
1100 H DD	2794,00
1120 H DD	2844,80
1140 H DD	2895,60
1150 H DD	2921,00
1250 H DD	3175,00
1400 H DD	3556,00
1645 H DD	4178,30
1700 H DD	4318,00
P	12,7
H₁	2,29
H	5,9

ISORAN Rubber endless timing belts

RPP3	
Code	Pitch length (mm)
90 RPP3	90
105 RPP3	105
129 RPP3	129
141 RPP3	141
144 RPP3	144
147 RPP3	147
150 RPP3	150
159 RPP3	159
168 RPP3	168
174 RPP3	174
177 RPP3	177
180 RPP3	180
186 RPP3	186
195 RPP3	195
201 RPP3	201
204 RPP3	204
210 RPP3	210
213 RPP3	213
225 RPP3	225
231 RPP3	231
240 RPP3	240
243 RPP3	243
246 RPP3	246
249 RPP3	249
252 RPP3	252
255 RPP3	255
261 RPP3	261
264 RPP3	264
267 RPP3	267
270 RPP3	270
276 RPP3	276
285 RPP3	285
288 RPP3	288
291 RPP3	291
297 RPP3	297
300 RPP3	300
312 RPP3	312
318 RPP3	318
327 RPP3	327
330 RPP3	330
333 RPP3	333
336 RPP3	336
339 RPP3	339
345 RPP3	345
351 RPP3	351
357 RPP3	357
363 RPP3	363
375 RPP3	375
384 RPP3	384
390 RPP3	390
393 RPP3	393
405 RPP3	405
420 RPP3	420
432 RPP3	432
447 RPP3	447
474 RPP3	474
480 RPP3	480
486 RPP3	486
489 RPP3	489
495 RPP3	495
501 RPP3	501
510 RPP3	510
513 RPP3	513
522 RPP3	522
531 RPP3	531
537 RPP3	537
564 RPP3	564
570 RPP3	570
576 RPP3	576
579 RPP3	579
582 RPP3	582
597 RPP3	597
600 RPP3	600
633 RPP3	633
648 RPP3	648
669 RPP3	669
711 RPP3	711
735 RPP3	735
738 RPP3	738
756 RPP3	756
804 RPP3	804
882 RPP3	882
945 RPP3	945
1062 RPP3	1062
1125 RPP3	1125
1245 RPP3	1245
1263 RPP3	1263
1500 RPP3	1500
1530 RPP3	1530
1863 RPP3	1863
P	3
H₁	1,15
H	2,4

RPP5	
Code	Pitch length (mm)
180 RPP5	180
225 RPP5	225
235 RPP5	235
245 RPP5	245
255 RPP5	255
265 RPP5	265
270 RPP5	270
280 RPP5	280
285 RPP5	285
295 RPP5	295
300 RPP5	300
305 RPP5	305
325 RPP5	325
330 RPP5	330
345 RPP5	345
350 RPP5	350
375 RPP5	375
400 RPP5	400
420 RPP5	420
425 RPP5	425
450 RPP5	450
455 RPP5	455
460 RPP5	460
465 RPP5	465
475 RPP5	475
500 RPP5	500
525 RPP5	525
535 RPP5	535
565 RPP5	565
575 RPP5	575
580 RPP5	580
600 RPP5	600
610 RPP5	610
615 RPP5	615
635 RPP5	635
640 RPP5	640
670 RPP5	670
675 RPP5	675
700 RPP5	700
705 RPP5	705
710 RPP5	710
725 RPP5	725
740 RPP5	740
750 RPP5	750
755 RPP5	755
800 RPP5	800
835 RPP5	835
850 RPP5	850
890 RPP5	890
900 RPP5	900
935 RPP5	935
940 RPP5	940
950 RPP5	950
980 RPP5	980
1000 RPP5	1000
1025 RPP5	1025
1050 RPP5	1050
1100 RPP5	1100
1125 RPP5	1125
1135 RPP5	1135
1195 RPP5	1195
1200 RPP5	1200
1240 RPP5	1240
1270 RPP5	1270
1420 RPP5	1420
1500 RPP5	1500
1595 RPP5	1595
1605 RPP5	1605
1690 RPP5	1690
1790 RPP5	1790
1800 RPP5	1800
1870 RPP5	1870
1895 RPP5	1895
1945 RPP5	1945
2000 RPP5	2000
2250 RPP5	2250
2525 RPP5	2525
P	5
H₁	2
H	3,8

RPP8	
Code	Pitch length (mm)
248 RPP8	248
288 RPP8	288
320 RPP8	320
352 RPP8	352
360 RPP8	360
376 RPP8	376
384 RPP8	384
408 RPP8	408
416 RPP8	416
424 RPP8	424
456 RPP8	456
480 RPP8	480
536 RPP8	536
544 RPP8	544
560 RPP8	560
600 RPP8	600
608 RPP8	608
632 RPP8	632
640 RPP8	640
680 RPP8	680
720 RPP8	720
760 RPP8	760
800 RPP8	800
840 RPP8	840
880 RPP8	880
896 RPP8	896
920 RPP8	920
960 RPP8	960
1000 RPP8	1000
1040 RPP8	1040
1080 RPP8	1080
1120 RPP8	1120
1160 RPP8	1160
1200 RPP8	1200
1224 RPP8	1224
1280 RPP8	1280
1352 RPP8	1352
1424 RPP8	1424
1440 RPP8	1440
1464 RPP8	1464
1600 RPP8	1600
1680 RPP8	1680
1760 RPP8	1760
1792 RPP8	1792
1800 RPP8	1800
1904 RPP8	1904
2000 RPP8	2000
2200 RPP8	2200
2240 RPP8	2240
2272 RPP8	2272
2400 RPP8	2400
2520 RPP8	2520
2600 RPP8	2600
2800 RPP8	2800
3048 RPP8	3048
3200 RPP8	3200
3280 RPP8	3280
3600 RPP8	3600
4000 RPP8	4000
4400 RPP8	4400
P	8
H₁	3,2
H	5,4

RPP14	
Code	Pitch length (mm)
966 RPP14	966
994 RPP14	994
1092 RPP14	1092
1106 RPP14	1106
1120 RPP14	1120
1190 RPP14	1190
1260 RPP14	1260
1288 RPP14	1288
1344 RPP14	1344
1400 RPP14	1400
1442 RPP14	1442
1568 RPP14	1568
1610 RPP14	1610
1750 RPP14	1750
1764 RPP14	1764
1778 RPP14	1778
1848 RPP14	1848
1890 RPP14	1890
1904 RPP14	1904
1960 RPP14	1960
2100 RPP14	2100
2240 RPP14	2240
2310 RPP14	2310
2380 RPP14	2380

RPP14	
Code	Pitch length (mm)
2450 RPP14	2450
2520 RPP14	2520
2590 RPP14	2590
2660 RPP14	2660
2800 RPP14	2800
2968 RPP14	2968
3136 RPP14	3136
3150 RPP14	3150
3304 RPP14	3304
3360 RPP14	3360
3500 RPP14	3500
3850 RPP14	3850
3920 RPP14	3920
4326 RPP14	4326
4410 RPP14	4410
4578 RPP14	4578
4956 RPP14	4956
P	14
H₁	6
H	9,7

RPP5 DD	
Code	Pitch length (mm)
600 RPP5 DD	600
610 RPP5 DD	610
615 RPP5 DD	615
635 RPP5 DD	635
640 RPP5 DD	640
670 RPP5 DD	670
675 RPP5 DD	675
700 RPP5 DD	700
705 RPP5 DD	705
710 RPP5 DD	710
725 RPP5 DD	725
740 RPP5 DD	740
750 RPP5 DD	750
755 RPP5 DD	755
800 RPP5 DD	800
835 RPP5 DD	835
850 RPP5 DD	850
890 RPP5 DD	890
900 RPP5 DD	900
935 RPP5 DD	935
940 RPP5 DD	940
950 RPP5 DD	950
980 RPP5 DD	980
1000 RPP5 DD	1000
1025 RPP5 DD	1025
1050 RPP5 DD	1050
1100 RPP5 DD	1100
1125 RPP5 DD	1125
1135 RPP5 DD	1135
1195 RPP5 DD	1195
1200 RPP5 DD	1200
1240 RPP5 DD	1240
1270 RPP5 DD	1270
1420 RPP5 DD	1420
1500 RPP5 DD	1500
1595 RPP5 DD	1595
1605 RPP5 DD	1605
1690 RPP5 DD	1690
1790 RPP5 DD	1790
1800 RPP5 DD	1800
1870 RPP5 DD	1870
1895 RPP5 DD	1895
1945 RPP5 DD	1945
2000 RPP5 DD	2000
2250 RPP5 DD	2250
2525 RPP5 DD	2525
P	5
H₁	2
H	5,2

RPP8DD	
Code	Pitch length (mm)
600 RPP8 DD	600
608 RPP8 DD	608
632 RPP8 DD	632
640 RPP8 DD	640
680 RPP8 DD	680
720 RPP8 DD	720
800 RPP8 DD	800
840 RPP8 DD	840
880 RPP8 DD	880
896 RPP8 DD	896
920 RPP8 DD	920
960 RPP8 DD	960
1000 RPP8 DD	1000
1040 RPP8 DD	1040
1080 RPP8 DD	1080
1120 RPP8 DD	1120
1200 RPP8 DD	1200
1224 RPP8 DD	1224
1280 RPP8 DD	1280
1352 RPP8 DD	1352
1424 RPP8 DD	1424
1440 RPP8 DD	1440
1464 RPP8 DD	1464
1600 RPP8 DD	1600
1680 RPP8 DD	1680
1760 RPP8 DD	1760
1800 RPP8 DD	1800
2000 RPP8 DD	2000
2200 RPP8 DD	2200
2272 RPP8 DD	2272
2400 RPP8 DD	2400
2520 RPP8 DD	2520
2600 RPP8 DD	2600
2800 RPP8 DD	2800
3048 RPP8 DD	3048
3280 RPP8 DD	3280
3600 RPP8 DD	3600
4400 RPP8 DD	4400
P	8
H₁	3,2
H	7,8

RPP14 DD	
Code	Pitch length (mm)
966 RPP14 DD	966
994 RPP14 DD	994
1092 RPP14 DD	1092
1106 RPP14 DD	1106
1190 RPP14 DD	1190
1260 RPP14 DD	1260
1288 RPP14 DD	1288
1344 RPP14 DD	1344
1400 RPP14 DD	1400
1442 RPP14 DD	1442
1568 RPP14 DD	1568
1610 RPP14 DD	1610
1750 RPP14 DD	1750
1764 RPP14 DD	1764
1778 RPP14 DD	1778
1848 RPP14 DD	1848
1890 RPP14 DD	1890
1904 RPP14 DD	1904
1960 RPP14 DD	1960
2100 RPP14 DD	2100
2240 RPP14 DD	2240
2310 RPP14 DD	2310
2380 RPP14 DD	2380
2450 RPP14 DD	2450
2590 RPP14 DD	2590
2660 RPP14 DD	2660
2800 RPP14 DD	2800
2968 RPP14 DD	2968
3150 RPP14 DD	3150
3360 RPP14 DD	3360
3500 RPP14 DD	3500
3850 RPP14 DD	3850
3920 RPP14 DD	3920
4326 RPP14 DD	4326
4578 RPP14 DD	4578
4956 RPP14 DD	4956
P	14
H₁	6
H	13,7

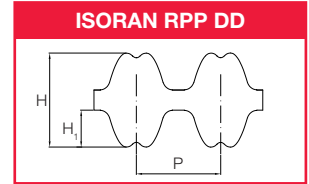
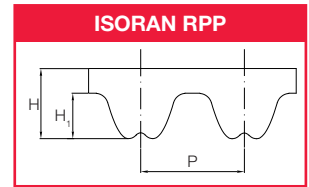

ISORAN

Rubber endless timing belts

ISORAN SILVER

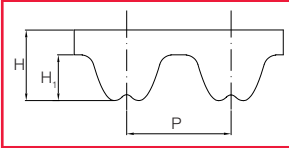

ISORAN SILVER DD

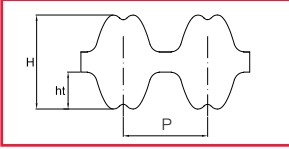

ISORAN GOLD

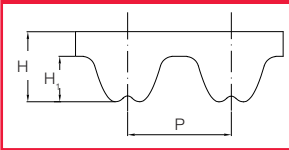

ISORAN PLATINUM

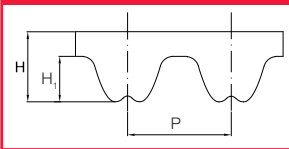

SLV5	
Code	Pitch length (mm)
800 SLV5	800
835 SLV5	835
850 SLV5	850
890 SLV5	890
900 SLV5	900
935 SLV5	935
940 SLV5	940
950 SLV5	950
980 SLV5	980
1000 SLV5	1000
1025 SLV5	1025
1050 SLV5	1050
1100 SLV5	1100
1125 SLV5	1125
1135 SLV5	1135
1195 SLV5	1195
1200 SLV5	1200
1240 SLV5	1240
1270 SLV5	1270
1420 SLV5	1420
1500 SLV5	1500
1595 SLV5	1595
1605 SLV5	1605
1690 SLV5	1690
1790 SLV5	1790
1800 SLV5	1800
1870 SLV5	1870
1895 SLV5	1895
1945 SLV5	1945
2000 SLV5	2000
2250 SLV5	2250
2525 SLV5	2525
P	5
H _i	2
H	3,8

SLV8	
Code	Pitch length (mm)
248 SLV8	248
288 SLV8	288
320 SLV8	320
352 SLV8	352
360 SLV8	360
384 SLV8	384
408 SLV8	408
416 SLV8	416
456 SLV8	456
480 SLV8	480
536 SLV8	536
544 SLV8	544
560 SLV8	560
600 SLV8	600
608 SLV8	608
632 SLV8	632
640 SLV8	640
680 SLV8	680
720 SLV8	720
760 SLV8	760
800 SLV8	800
840 SLV8	840
880 SLV8	880
896 SLV8	896
920 SLV8	920
960 SLV8	960
1000 SLV8	1000
1040 SLV8	1040
1080 SLV8	1080
1120 SLV8	1120
1160 SLV8	1160
1200 SLV8	1200
1224 SLV8	1224
1280 SLV8	1280
1352 SLV8	1352
1424 SLV8	1424
1440 SLV8	1440
1464 SLV8	1464
1600 SLV8	1600
1680 SLV8	1680
1760 SLV8	1760
1800 SLV8	1800
1904 SLV8	1904
2000 SLV8	2000
2200 SLV8	2200
2240 SLV8	2240
2272 SLV8	2272
2400 SLV8	2400
2520 SLV8	2520
2600 SLV8	2600
2800 SLV8	2800
2840 SLV8	2840
3048 SLV8	3048

SLV5	
Code	Pitch length (mm)
180 SLV5	180
225 SLV5	225
235 SLV5	235
245 SLV5	245
255 SLV5	255
265 SLV5	265
270 SLV5	270
280 SLV5	280
285 SLV5	285
295 SLV5	295
300 SLV5	300
305 SLV5	305
325 SLV5	325
345 SLV5	345
350 SLV5	350
375 SLV5	375
400 SLV5	400
420 SLV5	420
425 SLV5	425
450 SLV5	450
455 SLV5	455
460 SLV5	460
465 SLV5	465
475 SLV5	475
500 SLV5	500
525 SLV5	525
535 SLV5	535
565 SLV5	565
575 SLV5	575
580 SLV5	580
600 SLV5	600
610 SLV5	610
615 SLV5	615
635 SLV5	635
640 SLV5	640
670 SLV5	670
675 SLV5	675
700 SLV5	700
705 SLV5	705
710 SLV5	710
725 SLV5	725
740 SLV5	740
750 SLV5	750
755 SLV5	755

SLV8	
Code	Pitch length (mm)
3200 SLV8	3200
3280 SLV8	3280
3600 SLV8	3600
4000 SLV8	4000
4400 SLV8	4400
P	8
H _i	3,2
H	5,4

SLV14	
Code	Pitch length (mm)
966 SLV14	966
994 SLV14	994
1092 SLV14	1092
1106 SLV14	1106
1120 SLV14	1120
1190 SLV14	1190
1260 SLV14	1260
1288 SLV14	1288
1344 SLV14	1344
1400 SLV14	1400
1400 SLV14	1400
1442 SLV14	1442
1568 SLV14	1568
1610 SLV14	1610
1750 SLV14	1750
1764 SLV14	1764
1778 SLV14	1778
1848 SLV14	1848
1890 SLV14	1890
1904 SLV14	1904
1960 SLV14	1960
2100 SLV14	2100
2240 SLV14	2240
2310 SLV14	2310
2380 SLV14	2380
2450 SLV14	2450
2520 SLV14	2520
2590 SLV14	2590
2660 SLV14	2660
2800 SLV14	2800
2968 SLV14	2968
3136 SLV14	3136
3150 SLV14	3150
3304 SLV14	3304
3360 SLV14	3360
3500 SLV14	3500
3850 SLV14	3850
3920 SLV14	3920
4326 SLV14	4326
4410 SLV14	4410
4578 SLV14	4578
4956 SLV14	4956
P	14
H _i	6
H	9,7

SLV8 DD	
Code	Pitch length (mm)
600 SLV8 DD	600
608 SLV8 DD	608
632 SLV8 DD	632
640 SLV8 DD	640
680 SLV8 DD	680
720 SLV8 DD	720
800 SLV8 DD	800
840 SLV8 DD	840
880 SLV8 DD	880
896 SLV8 DD	896
920 SLV8 DD	920
960 SLV8 DD	960
1000 SLV8 DD	1000
1040 SLV8 DD	1040
1080 SLV8 DD	1080
1120 SLV8 DD	1120
1200 SLV8 DD	1200
1224 SLV8 DD	1224
1280 SLV8 DD	1280
1352 SLV8 DD	1352
1424 SLV8 DD	1424
1440 SLV8 DD	1440
1464 SLV8 DD	1464
1600 SLV8 DD	1600
1680 SLV8 DD	1680
1760 SLV8 DD	1760
1800 SLV8 DD	1800
2000 SLV8 DD	2000
2200 SLV8 DD	2200
2272 SLV8 DD	2272
2400 SLV8 DD	2400

SLV8 DD	
Code	Pitch length (mm)
2520 SLV8 DD	2520
2600 SLV8 DD	2600
2800 SLV8 DD	2800
3048 SLV8 DD	3048
3280 SLV8 DD	3280
3600 SLV8 DD	3600
4400 SLV8 DD	4400
P	8
H _i	3,2
H	7,8

SLV14 DD	
Code	Pitch length (mm)
966 SLV14 DD	966
994 SLV14 DD	994
1092 SLV14 DD	1092
1106 SLV14 DD	1106
1190 SLV14 DD	1190
1260 SLV14 DD	1260
1288 SLV14 DD	1288
1344 SLV14 DD	1344
1400 SLV14 DD	1400
1442 SLV14 DD	1442
1568 SLV14 DD	1568
1610 SLV14 DD	1610
1750 SLV14 DD	1750
1764 SLV14 DD	1764
1778 SLV14 DD	1778
1848 SLV14 DD	1848
1890 SLV14 DD	1890
1904 SLV14 DD	1904
1960 SLV14 DD	1960
2100 SLV14 DD	2100
2240 SLV14 DD	2240
2310 SLV14 DD	2310
2380 SLV14 DD	2380
2450 SLV14 DD	2450
2590 SLV14 DD	2590
2660 SLV14 DD	2660
2800 SLV14 DD	2800
2968 SLV14 DD	2968
3150 SLV14 DD	3150
3360 SLV14 DD	3360
3500 SLV14 DD	3500
3850 SLV14 DD	3850
3920 SLV14 DD	3920
4326 SLV14 DD	4326
4578 SLV14 DD	4578
4956 SLV14 DD	4956
P	14
H _i	6
H	13,7

GLD8	
Code	Pitch length (mm)
248 GLD8	248
288 GLD8	288
320 GLD8	320
352 GLD8	352
360 GLD8	360
384 GLD8	384
408 GLD8	408
416 GLD8	416
456 GLD8	456
480 GLD8	480
536 GLD8	536
544 GLD8	544
560 GLD8	560
600 GLD8	600
608 GLD8	608
632 GLD8	632
640 GLD8	640
680 GLD8	680
720 GLD8	720
800 GLD8	800
840 GLD8	840
880 GLD8	880
896 GLD8	896
920 GLD8	920
960 GLD8	960
1000 GLD8	1000
1040 GLD8	1040
1080 GLD8	1080
1120 GLD8	1120
1160 GLD8	1160
1200 GLD8	1200

GLD8	
Code	Pitch length (mm)
1224 GLD8	1224
1280 GLD8	1280
1352 GLD8	1352
1424 GLD8	1424
1440 GLD8	1440
1464 GLD8	1464
1600 GLD8	1600
1680 GLD8	1680
1760 GLD8	1760
1792 GLD8	1792
1800 GLD8	1800
1904 GLD8	1904
2000 GLD8	2000
2200 GLD8	2200
2240 GLD8	2240
2272 GLD8	2272
2400 GLD8	2400
2520 GLD8	2520
2600 GLD8	2600
2800 GLD8	2800
3048 GLD8	3048
3200 GLD8	3200
3280 GLD8	3280
3600 GLD8	3600
4000 GLD8	4000
4400 GLD8	4400
P	8
H _i	3,2
H	5,4

GLD14	
Code	Pitch length (mm)
966 GLD14	966
994 GLD14	994
1092 GLD14	1092
1106 GLD14	1106
1120 GLD14	1120
1190 GLD14	1190
1260 GLD14	1260
1288 GLD14	1288
1344 GLD14	1344
1400 GLD14	1400
1442 GLD14	1442
1568 GLD14	1568
1610 GLD14	1610
1750 GLD14	1750
1764 GLD14	1764
1778 GLD14	1778
1848 GLD14	1848
1890 GLD14	1890
1904 GLD14	1904
1960 GLD14	1960
2100 GLD14	2100
2240 GLD14	2240
2310 GLD14	2310
2380 GLD14	2380
2450 GLD14	2450
2520 GLD14	2520
2590 GLD14	2590
2660 GLD14	2660
2800 GLD14	2800
2968 GLD14	2968
3136 GLD14	3136
3150 GLD14	3150
3304 GLD14	3304
3360 GLD14	3360
3500 GLD14	3500
3850 GLD14	3850
3920 GLD14	3920
4326 GLD14	4326
4410 GLD14	4410
4578 GLD14	4578
4956 GLD14	4956
P	14
H _i	6
H	9,7

PLT8	
Code	Pitch length (mm)
248 PLT8	248
288 PLT8	288
352 PLT8	352
416 PLT8	416
456 PLT8	456
480 PLT8	480
544 PLT8	544
560 PLT8	560
608 PLT8	608
640 PLT8	640
720 PLT8	720
800 PLT8	800
840 PLT8	840
896 PLT8	896
960 PLT8	960
1000 PLT8	1000
1040 PLT8	1040
1120 PLT8	1120
1224 PLT8	1224
1280 PLT8	1280
1440 PLT8	1440
1600 PLT8	1600
1760 PLT8	1760
1792 PLT8	1792
2000 PLT8	2000
2200 PLT8	2200
2240 PLT8	2240
2400 PLT8	2400
2520 PLT8	2520
2600 PLT8	2600
2800 PLT8	2800
2840 PLT8	2840
3048 PLT8	3048
3600 PLT8	3600
4000 PLT8	4000
P	8
H _i	3,2
H	5,4

PLT14	
Code	Pitch length (mm)
994 PLT14	994
1092 PLT14	1092
1120 PLT14	1120
1260 PLT14	1260
1400 PLT14	1400
1568 PLT14	1568
1610 PLT14	1610
1750 PLT14	1750
1890 PLT14	1890
1960 PLT14	1960
2100 PLT14	2100
2240 PLT14	2240

ISORAN OPEN-END
Rubber timing belt rolls

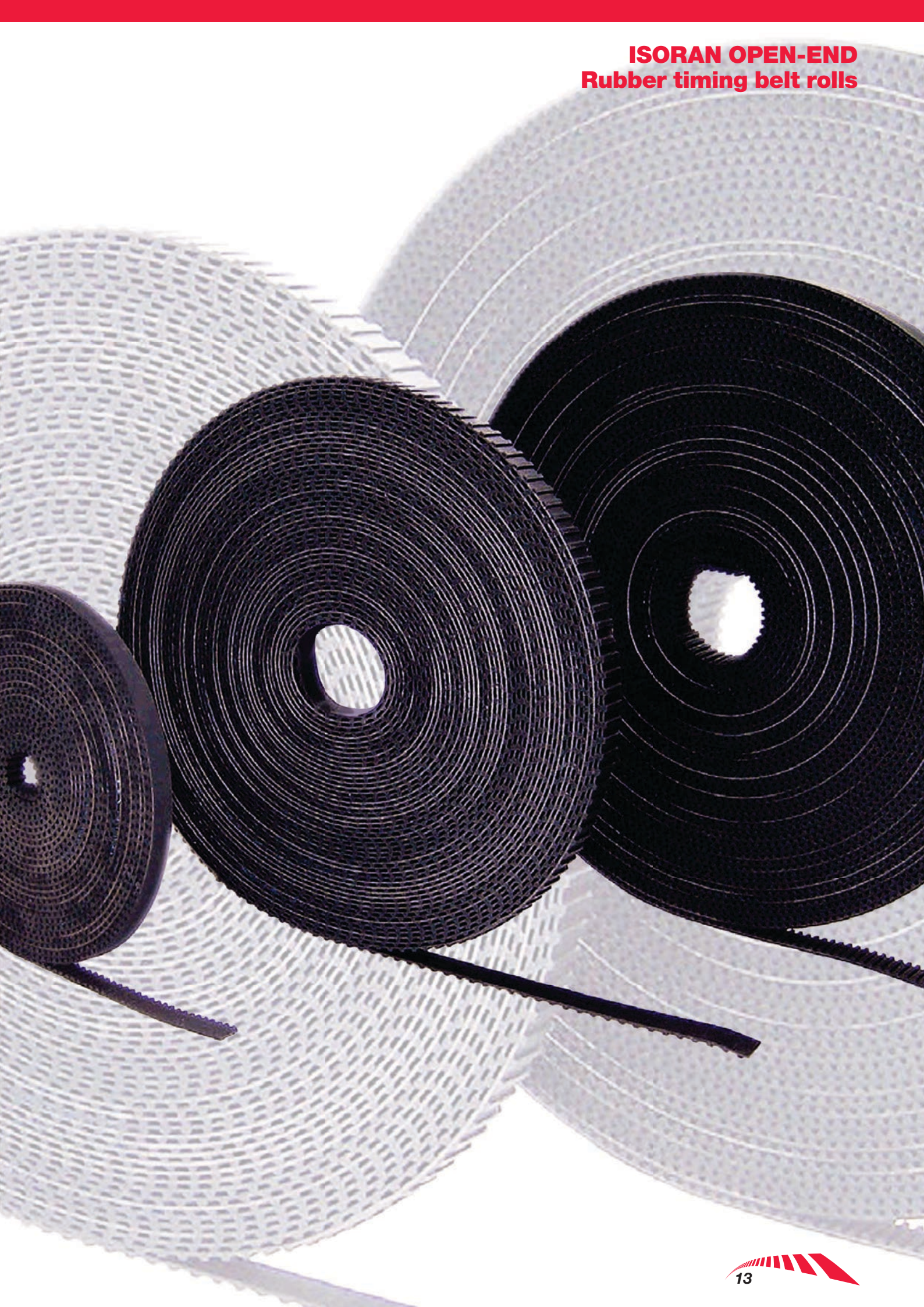

ISORAN OPEN-END Rubber timing belt rolls



ISORAN OPEN-END RUBBER SYNCHRONOUS BELTS

Specially suitable for linear drives, accurate positioning and reversal drives.

A high load capacity, no maintenance cost and very low noise level, make this belt a perfect alternative to chain or cable reverse drives.

Megadyne Open-end rubber belts, produced both in straight and spiral cut, are available in the following profiles, pitches and constructions:

- ISORAN MXL; XL; L; H
- ISORAN RPP RPP3; RPP5; RPP8
- ISORAN RPP SILVER SLV5; SLV8
- STD STD8

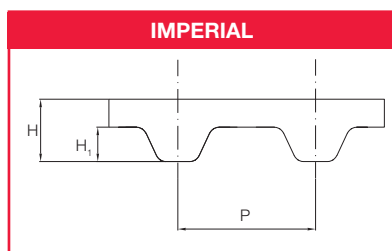

MXL	
Std. width (inches)	
	0,25
	0,31
	0,37
P	2,032
H	1,14
H ₁	0,51

XL	
Std. width (inches)	
	0,25
	0,31
	0,37
P	5,08
H	2,4
H ₁	1,27

L	
Std. width (inches)	
	0,50
	0,75
	1,00
P	9,525
H	3,6
H ₁	1,91

H	
Std. width (inches)	
	0,50
	0,75
	1,00
	1,50
	2,00
	3,00
P	12,7
H	4,4
H ₁	2,29

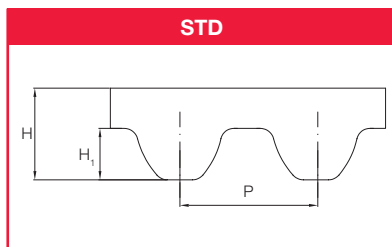

STD8 M	
Std. width (mm)	
	10
	12
	15
	20
	25
P	8
H	5,3
H ₁	3,05

RPP3	
Std. width (mm)	
	9
	12
	15
P	3
H	2,4
H ₁	1,15

RPP5	
Std. width (mm)	
	9
	12
	15
	20
	25
	30
P	5
H	3,8
H ₁	2

RPP8	
Std. width (mm)	
	10
	15
	20
	25
	30
	50
	85
P	8
H	5,4
H ₁	3,2

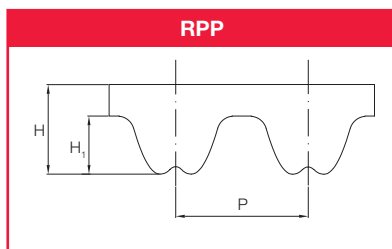

SLV5	
Std. width (mm)	
	15
	25
P	5
H	3,8
H ₁	2

SLV8	
Std. width (mm)	
	10
	15
	20
	25
P	8
H	5,4
H ₁	3,2

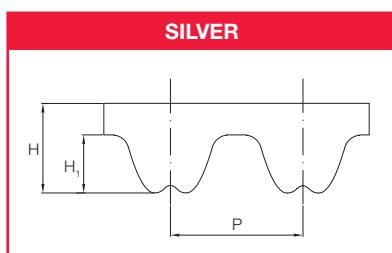

EXTRA - OLEOSTATIC - OLEOSTATIC GOLD
ESAFLEX - XDV2 PLURIBAND - CONTRAFOR
Rubber wrapped V-Belts



EXTRA - OLEOSTATIC - OLEOSTATIC GOLD - ESAFLEX - XDV2 PLURIBAND - CONTRAFOR Rubber wrapped V-Belts



WRAPPED V-BELTS are manufactured in polybutadiene compound. High variety of belt sizes available permits the application of Megadyne V-belts on all types of industrial equipments. Applied technology allows to reach so good dimensional precision in V-belts to make them suitable for multiple transmissions. This dimensional stability continues also during belt use.

MECHANICAL FEATURES

- Smooth starting and running
- Wide range of driven speeds, using standard electric motors
- Low maintenance
- High efficient
- No need for lubrication
- Extremely wide horsepower ranges
- Dampen vibration between driver and driven pulleys
- Silent operations
- Long service life
- Easy installation
- Reduction in drive dimension

EXTRA

Extra belts were designed to offer durable and reliable performances on light and medium-duty drives. They represent an affordable solution for transmission systems of all industrial sectors.

OLEOSTATIC

Oleostatic rubber belts are developed with high resistant tensile elements, they are characterised by high performances, length stability during belts life, conductivity, oil and heat resistance. They are particularly suitable for centrifugal pumps, compressor, tool machines, generators, high power mills and stone mills.

OLEOSTATIC GOLD

Different materials and design features, together with an improved production process, have led to the development of a new class of higher rated wrapped V-belts. The new OLEOSTATIC GOLD V-belts product family can operate in a wide range of industrial applications, within a large spread of load capacities and speeds - offering rated performance from 100 to 8,000 RPM and power capability from 1 to 400 kW, meanwhile granting large cost advantages for the end users.

MEGAMATCH MEGA MATCH

All Oleostatic and Extra V-belts carrying the MEGA MATCH logo are made and supplied according to the matching set tolerances and limits indicated by the relevant international standards (ISO,RMA, etc)

ESAFLEX

Esaflex are ideally suited for serpentine drives where power needs to be transmitted equally from both sides of the belt. Double wrapped cotton neoprene cover is added for excellent resistance to abrasive wear, heat, ozone, sunlight, grease oil or dirt. Centrally located cord and special synthetic rubber compounds assure long belt life and a smooth drive.

XDV2 BELTS

The XDV2 belts has been created for drives with small pulley diameters and high temperature peaks, combined with a high grade of moisture and humidity. It withstands the harshest environmental requirements, such as oil and grease contaminated drives of transmissions where grits may interfere between pulleys and belt.

Thanks to its characteristics, the XDV2 perfectly matches the requirements of clutching drives as the aramid cords protect the belt against shock loads while maintaining its length constant.

PLURIBAND

Banded version of V-Belts eliminates belt whip and turnover on wedge-type drives. Patented bending process insures smooth operation. Oil and heat resistant, static dissipating.

CONTRAFOR

Contrafor belts feature a continuous series of equidistant holes positioned along the centre line of the section. These holes are needed not only to mount the belts, but can also be used to install equipment or tools made for carrying out various types of winding operations .

Special constructions are available on request.



EXTRA - OLEOSTATIC - OLEOSTATIC GOLD Rubber wrapped V-Belts



SECTION Z		SECTION Z		SECTION Z		SECTION A		SECTION A		SECTION A			
Code	Internal length Ll (mm)	Code	Internal length Ll (mm)	Code	Internal length Ll (mm)	Code	Internal length Ll (mm)	Code	Internal length Ll (mm)	Code	Internal length Ll (mm)		
Z 16	410	Z 34 1/4	870	Z 59	1500	A 18	457	A 38	965	A 60	1525	A 95	2413
Z 18	460	Z 35	890	Z 59 1/2	1515	A 19	480	A 38 1/2	975	A 61	1550	A 96	2438
Z 19	480	Z 35 1/2	900	Z 60	1525	A 20	508	A 39	992	A 62	1575	A 97	2464
Z 19 1/2	500	Z 36	915	Z 61	1550	A 21	535	A 39 1/2	1000	A 63	1600	A 97 1/2	2475
Z 20	508	Z 36 1/2	925	Z 62	1575	A 21 3/4	552	A 40	1016	A 64	1625	A 98	2500
Z 20 1/2	520	Z 36 3/4	935	Z 63	1600	A 22	560	A 40 1/2	1030	A 65	1650	A 100	2540
Z 21	530	Z 37	945	Z 64	1625	A 23	587	A 41	1041	A 66	1676	A 102	2591
Z 21 1/4	540	Z 37 1/2	950	Z 65	1651	A 23 1/2	600	A 41 1/2	1050	A 67	1700	A 104	2650
Z 21 1/2	545	Z 38	965	Z 66	1675	A 24	610	A 41 3/4	1060	A 68	1725	A 105	2667
Z 21 3/4	555	Z 38 1/4	975	Z 67	1700	A 24 1/2	620	A 42	1067	A 69	1750	A 107	2725
Z 22	560	Z 38 1/2	978	Z 68	1727	A 24 3/4	630	A 42 1/2	1075	A 70	1775	A 108	2743
Z 22 1/4	565	Z 39	1000	Z 68 1/2	1740	A 25	637	A 43	1100	A 70 3/4	1780	A 110	2800
Z 22 1/2	575	Z 40	1016	Z 69	1750	A 25 1/2	647	A 43 1/2	1105	A 71	1800	A 112	2845
Z 23	585	Z 40 1/2	1030	Z 70	1778	A 26	660	A 43 3/4	1111	A 72	1825	A 113	2870
Z 23 1/2	600	Z 41	1040	Z 71	1803	A 26 1/2	670	A 44	1120	A 73	1854	A 114	2896
Z 23 3/4	605	Z 41 1/2	1050	Z 73	1855	A 27	686	A 44 1/2	1132	A 74	1880	A 116	2946
Z 24	610	Z 41 3/4	1060	Z 75	1905	A 27 1/2	700	A 45	1143	A 75	1900	A 118	3000
Z 24 3/4	630	Z 42	1070	Z 78	1982	A 28	710	A 45 1/2	1150	A 76	1930	A 120	3048
Z 25	635	Z 42 1/2	1080	Z 79	2007	A 28 1/2	724	A 46	1168	A 77	1956	A 124	3150
Z 25 1/2	650	Z 43	1090	Z 83 1/2	2100	A 29	737	A 46 1/2	1180	A 78	1980	A 128	3250
Z 26	660	Z 43 1/4	1100	Z 88	2235	A 29 1/2	750	A 47	1200	A 79	2000	A 130	3302
Z 26 1/2	670	Z 44	1120	Z 93	2360	A 30	767	A 47 1/2	1207	A 80	2032	A 132	3350
Z 27	685	Z 45	1145	Z 98	2489	A 30 1/2	775	A 48	1220	A 81	2060	A 134	3404
Z 27 1/2	700	Z 46	1180			A 31	787	A 48 1/2	1232	A 82	2083	A 136	3454
Z 28	710	Z 47	1194			A 31 1/2	800	A 48 1/4	1225	A 83	2100	A 140	3550
Z 28 1/2	725	Z 47 3/4	1215			A 32	813	A 49	1250	A 83 1/2	2120	A 144	3658
Z 29	735	Z 48	1225			A 32 1/2	825	A 50	1270	A 84	2134	A 147	3737
Z 29 1/2	750	Z 48 1/2	1232			A 33	838	A 51	1300	A 84 1/2	2146	A 148	3750
Z 30	765	Z 49	1245			A 33 1/4	847	A 51 1/2	1307	A 85	2160	A 155	3937
Z 30 1/2	775	Z 50	1270			A 33 1/2	850	A 52	1320	A 86	2187	A 158	4000
Z 30 3/4	785	Z 50 1/2	1285			A 34	867	A 52 1/2	1337	A 86 1/2	2200	A 162	4115
Z 31	787	Z 51	1300			A 34 1/2	875	A 53	1346	A 87	2212	A 167	4250
Z 31 1/2	800	Z 52	1320			A 35	900	A 53 1/4	1355	A 88	2240	A 173	4394
Z 32	815	Z 53	1345			A 35 1/2	902	A 54	1372	A 89	2267	A 177	4500
Z 32 1/2	825	Z 54	1371			A 36	914	A 55	1400	A 90	2286	A 187*	4750
Z 33	840	Z 55	1400			A 36 1/2	925	A 56	1422	A 91	2311	A 197*	5000
Z 33 1/2	850	Z 56	1422			A 37	942	A 57	1450	A 92	2337	A 210*	5334
Z 34	865	Z 57	1450			A 37 1/4	946	A 58	1475	A 93	2360	A 217*	5477
Z 34 1/2	875	Z 58	1473			A 37 1/2	950	A 59	1500	A 94	2388		



SECTION B		SECTION B		SECTION B		SECTION B		SECTION B		SECTION B	
Code	Internal length Ll (mm)	Code	Internal length Ll (mm)	Code	Internal length Ll (mm)	Code	Internal length Ll (mm)	Code	Internal length Ll (mm)	Code	Internal length Ll (mm)
B 22 1/2	570	B 41 3/4	1060	B 65	1650	B 95	2413	B 142	3607	B 224*	5657
B 23	587	B 42	1067	B 66	1676	B 96	2438	B 144	3658	B 225*	5682
B 24	612	B 42 1/2	1075	B 66 1/4	1682	B 96 1/2	2450	B 146	3708	B 228*	5757
B 25	637	B 43	1090	B 66 1/2	1692	B 97	2465	B 147	3737	B 229*	5782
B 26	650	B 43 1/2	1100	B 67	1700	B 97 1/2	2477	B 148	3750	B 236*	5994
B 26 1/2	673	B 43 1/4	1096	B 67 1/4	1712	B 98	2500	B 150	3810	B 237*	6000
B 27	686	B 44	1120	B 68	1725	B 99	2515	B 151	3850	B 240*	6062
B 28	710	B 44 1/4	1127	B 69	1750	B 100	2540	B 152	3861	B 248*	6267
B 28 1/2	725	B 45	1142	B 69 1/2	1761	B 101	2565	B 154	3912	B 249*	6287
B 29	737	B 45 1/2	1155	B 70	1775	B 102	2600	B 155	3950	B 253*	6392
B 29 1/2	750	B 46	1175	B 71	1800	B 103	2616	B 156	3962	B 255*	6442
B 30	762	B 46 1/2	1180	B 72	1829	B 104	2650	B 157	3987	B 256*	6502
B 30 1/2	775	B 46 3/4	1187	B 73	1850	B 105	2667	B 158	4000	B 259*	6542
B 31	787	B 47	1200	B 74	1880	B 106	2700	B 160	4064	B 264*	6665
B 31 1/2	800	B 47 1/2	1215	B 75	1900	B 107	2718	B 161	4087	B 265*	6700
B 32	812	B 47 1/4	1202	B 76	1930	B 108	2750	B 162	4115	B 269*	6800
B 32 1/4	822	B 48	1225	B 77	1950	B 109	2769	B 163	4142	B 270*	6825
B 32 1/2	825	B 48 1/2	1232	B 78	1981	B 110	2800	B 165	4200	B 276*	7000
B 33	838	B 49	1250	B 79	2000	B 112	2845	B 167	4250	B 280*	7100
B 33 1/2	850	B 50	1275	B 80	2032	B 112 1/2	2857	B 168	4267	B 175	4450
B 34	867	B 51	1300	B 80 3/4	2050	B 114	2900	B 173	4394	B 177	4500
B 34 1/2	875	B 52	1320	B 81	2060	B 115	2921	B 175	4450	B 180*	4572
B 35	889	B 52 1/2	1336	B 82	2083	B 116	2950	B 177	4500	B 186*	4727
B 35 1/2	900	B 53	1350	B 83	2108	B 118	3000	B 187*	4750	B 188*	4777
B 35 3/4	907	B 53 1/2	1360	B 83 1/2	2120	B 120	3048	B 188*	4777	B 192*	4877
B 36	917	B 54	1372	B 84	2134	B 122	3099	B 195*	4953	B 197*	5000
B 36 1/2	925	B 55	1400	B 85	2160	B 124	3150	B 204*	5182	B 208*	5300
B 36 3/4	937	B 55 1/2	1412	B 86	2187	B 126	3200	B 210*	5334	B 217*	5507
B 37	942	B 56	1422	B 86 1/2	2200	B 127	3227	B 220*	5552	B 221*	5577
B 37 1/2	950 L	B 57	1450	B 87	2215	B 128	3250	B 136	3450	B 138	3505
B 38	965	B 58	1473	B 88	2240	B 130	3302	B 138	3505	B 140	3550
B 38 1/2	975	B 59	1500	B 89	2261	B 131	3327				
B 39	990	B 60	1525	B 90	2286	B 132	3350				
B 39 1/2	1000	B 61	1550	B 91	2312	B 133	3378				
B 40	1016	B 62	1575	B 92	2337	B 134	3407				
B 40 1/2	1030	B 63	1600	B 93	2360	B 135	3429				
B 41	1040	B 64	1625	B 94	2388	B 136	3450				
B 41 1/2	1050	B 64 1/2	1642	B 94 1/2	2400	B 138	3505				

* Available only in OLEOSTATIC version.

EXTRA - OLEOSTATIC - OLEOSTATIC GOLD

Rubber wrapped V-Belts

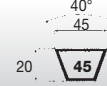
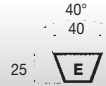
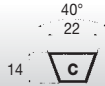

SECTION C	
Code	Internal length LI (mm)
C 33 3/4	858
C 37 1/2	950
C 39 3/4	1013
C 43	1090
C 45	1150
C 46	1168
C 48	1220
C 47	1194
C 49	1250
C 51	1295
C 52	1320
C 53	1350
C 54	1372
C 55	1400
C 56	1425
C 57	1450
C 58	1473
C 59	1500
C 60	1524
C 61	1560
C 62	1576
C 62 1/4	1583
C 63	1600
C 65	1650
C 66	1676
C 67	1700
C 68	1727
C 69	1753
C 70	1778
C 71	1798
C 72	1829
C 73	1854
C 74	1879
C 75	1900
C 76	1930
C 77	1955
C 78	1978
C 79	2005
C 80	2032
C 81	2057
C 82	2080
C 83	2108
C 83 1/2	2121
C 84	2134
C 85	2159
C 86	2184
C 87	2208
C 88	2235
C 89	2261
C 90	2286
C 92	2337
C 93	2360
C 94	2388
C 95	2413
C 96	2438
C 96 1/2	2450
C 97	2462
C 97 1/2	2477
C 98	2500
C 99	2525
C 100	2540
C 101	2560
C 102	2591
C 104	2642
C 105	2667
C 106	2692
C 108	2750
C 110	2800
C 111	2818
C 112	2845
C 112 1/2	2858
C 114	2888
C 115	2921
C 116	2950
C 117	2965
C 118	3000
C 120	3048
C 122	3099
C 124	3150
C 126	3200
C 128	3250
C 130	3302
C 132	3350
C 134	3404
C 136	3456

SECTION C	
Code	Internal length LI (mm)
C 138	3498
C 140	3550
C 142	3607
C 144	3658
C 147	3733
C 148	3750
C 150	3808
C 153	3902
C 158	4000
C 160	4064
C 161 1/2	4100
C 162	4115
C 165	4193
C 166	4216
C 167	4242
C 168	4267
C 170	4318
C 173	4394
C 175	4445
C 177	4500
C 180*	4572
C 187*	4750
C 190*	4826
C 195*	4953
C 197*	5000
C 204*	5182
C 208*	5300
C 210*	5334
C 216*	5486
C 220*	5550
C 222*	5600
C 225*	5678
C 228*	5753
C 236*	6000
C 238*	6045
C 240*	6062
C 248*	6263
C 250*	6300
C 255*	6438
C 264*	6670
C 265*	6700
C 270*	6822
C 276*	6973
C 280*	7100
C 285*	7203
C 295*	7493
C 297*	7500
C 300*	7582
C 303*	7650
C 314*	7976
C 315*	7965
C 316*	8000
C 320*	8093
C 330*	8382
C 336*	8500
C 345*	8723
C 360*	9107
C 394*	10000
C 420*	10632
C 424*	10733

SECTION D*	
Code	Internal length LI (mm)
D 79	2010
D 98	2500
D 104	2650
D 110	2800
D 118	3000
D 120	3048
D 124	3150
D 128	3251
D 132	3435
D 134	3403
D 135	3429
D 136	3454
D 137	3475
D 140	3550
D 144	3658
D 148	3760
D 154	3914
D 158	4013
D 162	4115
D 167	4241
D 170	4310
D 173	4394
D 175	4445
D 177	4500
D 180	4572
D 187	4750
D 195	4953
D 197	5000
D 204	5182
D 205	5209
D 207	5259
D 208	5283
D 210	5334
D 220	5588
D 223	5600
D 225	5659
D 236	5940
D 238	6000
D 240	6039
D 248	6244
D 250	6294
D 255	6424
D 264	6650
D 266	6700
D 270	6804
D 280	7050
D 282	7100
D 285	7184
D 295	7425
D 298	7500
D 300	7565
D 314	7924
D 315	7950
D 316	7974
D 326	8224
D 330	8329
D 345	8709
D 354	8940
D 360	9090
D 374	9445
D 390	9849
D 394	10000
D 420	10624
D 441	11200
D 480	12139
D 510	12897
D 540	13659
D 600	15184

SECTION E*	
Code	Internal length LI (mm)
E 180	4575
E 197	5000
E 210	5335
E 220	5600
E 226	5660
E 240	6015
E 248	6220
E 255	6400
E 270	6780
E 280	7100
E 285	7160
E 295	7500
E 300	7540
E 316	7950
E 330	8305
E 345	8685
E 354	9000
E 360	9065
E 394	9930
E 420	10600
E 441	11200
E 480	12115
E 492	12500
E 540	13635
E 600	15160

SECTION 25*	
Code	Internal length LI (mm)
25	1800
25	1900
25	1950
25	2000
25	2050
25	2120
25	2120
25	2200
25	2240
25	2325
25	2360
25	2450
25	2500
25	2650
25	2700
25	2800
25	2950
25	3000
25	3150
25	3300
25	3350
25	3550
25	3750
25	3950
25	4000
25	4250
25	4450
25	4500
25	4750
25	5000
25	5300
25	5600
25	5700
25	6000
25	6300
25	6500
25	6700
25	7100
25	7500
25	8000
25	8500
25	9000
25	9500
25	10000

SECTION 45*	
Code	Internal length LI (mm)
45	2000
45	2300
45	2500
45	2650
45	2750
45	2850
45	3000
45	3150
45	3250
45	3300
45	3500
45	3750
45	4000



SECTION 20*	
Code	Internal length LI (mm)
20	1800
20	1875
20	1900
20	1925
20	1950
20	2000
20	2050
20	2120
20	2200
20	2240
20	2360
20	2500
20	2600
20	2650
20	2800
20	3000
20	3150
20	3250
20	3350
20	3450
20	3550
20	3650
20	3750
20	4000
20	4250
20	4500
20	4750
20	5000
20	5300
20	5600
20	6000



*Available only in OLEOSTATIC version.

EXTRA - OLEOSTATIC - OLEOSTATIC GOLD Rubber wrapped V-Belts



SECTION SPZ	
Code	External length LA (mm)
SPZ 487	500
SPZ 512	525
SPZ 562	575
SPZ 587	600
SPZ 607	620
SPZ 612	625
SPZ 630	643
SPZ 637	650
SPZ 662	675
SPZ 670	683
SPZ 687	700
SPZ 710	723
SPZ 722	735
SPZ 737	750
SPZ 750	763
SPZ 762	775
SPZ 772	785
SPZ 787	800
SPZ 800	813
SPZ 812	825
SPZ 825	838
SPZ 837	850
SPZ 850	863
SPZ 862	875
SPZ 875	888
SPZ 887	900
SPZ 900	913
SPZ 912	925
SPZ 922	935
SPZ 925	938
SPZ 937	950
SPZ 950	963
SPZ 962	975
SPZ 975	988
SPZ 987	1000
SPZ 1000	1013
SPZ 1010	1023
SPZ 1012	1025
SPZ 1024	1037
SPZ 1037	1050
SPZ 1047	1060
SPZ 1060	1073
SPZ 1077	1090
SPZ 1087	1100
SPZ 1112	1125
SPZ 1120	1133
SPZ 1137	1150
SPZ 1140	1153
SPZ 1147	1160
SPZ 1150	1163
SPZ 1162	1175
SPZ 1180	1193
SPZ 1187	1200
SPZ 1200	1213
SPZ 1202	1215
SPZ 1212	1225
SPZ 1237	1250
SPZ 1250	1263
SPZ 1262	1275
SPZ 1270	1283
SPZ 1287	1300
SPZ 1312	1325
SPZ 1320	1333
SPZ 1337	1350
SPZ 1340	1353
SPZ 1347	1360
SPZ 1362	1375
SPZ 1387	1400
SPZ 1400	1413
SPZ 1412	1425
SPZ 1420	1433
SPZ 1437	1450
SPZ 1462	1475
SPZ 1470	1483
SPZ 1487	1500
SPZ 1500	1513
SPZ 1512	1525
SPZ 1520	1533
SPZ 1537	1550
SPZ 1562	1575
SPZ 1587	1600
SPZ 1600	1613
SPZ 1612	1625
SPZ 1637	1650
SPZ 1650	1663
SPZ 1662	1675

SECTION SPZ	
Code	External length LA (mm)
SPZ 1687	1700
SPZ 1700	1713
SPZ 1737	1750
SPZ 1750	1763
SPZ 1762	1775
SPZ 1787	1800
SPZ 1800	1813
SPZ 1812	1825
SPZ 1837	1850
SPZ 1850	1863
SPZ 1862	1875
SPZ 1887	1900
SPZ 1900	1913
SPZ 1937	1950
SPZ 1962	1975
SPZ 1987	2000
SPZ 2000	2013
SPZ 2019	2032
SPZ 2030	2043
SPZ 2037	2050
SPZ 2062	2075
SPZ 2087	2100
SPZ 2120	2133
SPZ 2137	2150
SPZ 2150	2163
SPZ 2160	2173
SPZ 2187	2200
SPZ 2240	2253
SPZ 2262	2275
SPZ 2287	2300
SPZ 2360	2373
SPZ 2410	2423
SPZ 2437	2450
SPZ 2487	2500
SPZ 2500	2513
SPZ 2540	2553
SPZ 2650	2663
SPZ 2690	2703
SPZ 2800	2813
SPZ 2840	2853
SPZ 3000	3013
SPZ 3150	3163
SPZ 3350	3363
SPZ 3550	3563

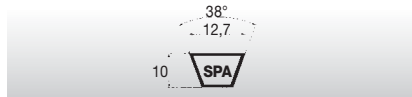

SECTION SPA	
Code	External length LA (mm)
SPA 657	675
SPA 707	725
SPA 732	750
SPA 757	775
SPA 782	800
SPA 800	818
SPA 807	825
SPA 832	850
SPA 850	868
SPA 857	875
SPA 882	900
SPA 900	918
SPA 907	925
SPA 925	943
SPA 932	950
SPA 950	968
SPA 957	975
SPA 967	985
SPA 982	1000
SPA 1000	1018
SPA 1007	1025
SPA 1032	1050
SPA 1060	1078
SPA 1082	1100
SPA 1107	1125
SPA 1120	1138
SPA 1132	1150
SPA 1150	1168
SPA 1157	1175
SPA 1180	1198
SPA 1207	1225
SPA 1232	1250
SPA 1250	1268
SPA 1257	1275
SPA 1272	1290
SPA 1282	1300
SPA 1307	1325
SPA 1320	1338
SPA 1332	1350
SPA 1357	1375
SPA 1382	1400
SPA 1400	1418
SPA 1407	1425
SPA 1425	1443
SPA 1432	1450
SPA 1450	1468
SPA 1457	1475
SPA 1482	1500
SPA 1500	1518
SPA 1507	1525
SPA 1532	1550
SPA 1550	1568
SPA 1557	1575
SPA 1582	1600
SPA 1600	1618
SPA 1607	1625
SPA 1632	1650
SPA 1657	1675
SPA 1682	1700
SPA 1700	1718
SPA 1707	1725
SPA 1732	1750
SPA 1750	1768
SPA 1757	1775
SPA 1782	1800
SPA 1800	1818
SPA 1807	1825
SPA 1832	1850
SPA 1857	1875
SPA 1882	1900
SPA 1900	1918
SPA 1907	1925
SPA 1925	1943
SPA 1932	1950
SPA 1950	1968
SPA 1957	1975
SPA 1982	2000
SPA 2000	2018
SPA 2032	2050
SPA 2057	2075
SPA 2082	2100
SPA 2120	2138
SPA 2132	2150
SPA 2182	2200
SPA 2207	2225
SPA 2232	2250

SECTION SPA	
Code	External length LA (mm)
SPA 2240	2258
SPA 2282	2300
SPA 2300	2318
SPA 2307	2325
SPA 2332	2350
SPA 2360	2378
SPA 2382	2400
SPA 2432	2450
SPA 2482	2500
SPA 2500	2518
SPA 2532	2550
SPA 2582	2600
SPA 2607	2625
SPA 2632	2650
SPA 2650	2668
SPA 2682	2700
SPA 2732	2750
SPA 2782	2800
SPA 2800	2818
SPA 2832	2850
SPA 2847	2865
SPA 2882	2900
SPA 2900	2918
SPA 2932	2950
SPA 2982	3000
SPA 3000	3018
SPA 3032	3050
SPA 3082	3100
SPA 3150	3168
SPA 3182	3200
SPA 3250	3268
SPA 3282	3300
SPA 3350	3368
SPA 3382	3400
SPA 3550	3568
SPA 3650	3668
SPA 3750	3768
SPA 4000	4018
SPA 4250	4268
SPA 4500	4518
SPA 4750*	4768

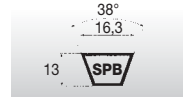

SECTION SPB	
Code	External length LA (mm)
SPB 1250	1272
SPB 1320	1342
SPB 1400	1422
SPB 1410	1432
SPB 1450	1472
SPB 1500	1522
SPB 1600	1622
SPB 1650	1672
SPB 1700	1722
SPB 1750	1772
SPB 1800	1822
SPB 1850	1872
SPB 1860	1882
SPB 1900	1922
SPB 1950	1972
SPB 2000	2022
SPB 2020	2042
SPB 2060	2082
SPB 2098	2120
SPB 2120	2142
SPB 2150	2172
SPB 2180	2202
SPB 2240	2262
SPB 2264	2286
SPB 2280	2302
SPB 2300	2322
SPB 2360	2382
SPB 2391	2413
SPB 2400	2422
SPB 2410	2432
SPB 2430	2452
SPB 2450	2472
SPB 2500	2522
SPB 2530	2552
SPB 2580	2602
SPB 2600	2622
SPB 2650	2672
SPB 2680	2702
SPB 2720	2742
SPB 2800	2822
SPB 2840	2862
SPB 2850	2872
SPB 2900	2922
SPB 2950	2972
SPB 3000	3022
SPB 3070	3092
SPB 3150	3172
SPB 3170	3192
SPB 3250	3272
SPB 3320	3342
SPB 3350	3372
SPB 3450	3472
SPB 3550	3572
SPB 3650	3672
SPB 3750	3772
SPB 3800	3822
SPB 4000	4022
SPB 4050	4072
SPB 4250	4272
SPB 4300	4322
SPB 4560	4582
SPB 4500	4522
SPB 4750*	4772
SPB 4820*	4842
SPB 5000*	5022
SPB 5070*	5092
SPB 5300*	5322
SPB 5600*	5622
SPB 6000*	6022
SPB 6300*	6322
SPB 6700*	6722
SPB 7100*	7122
SPB 7500*	7522
SPB 8000*	8022



SECTION SPC	
Code	External length LA (mm)
SPC 2000	2030
SPC 2120	2150
SPC 2240	2270
SPC 2360	2390
SPC 2500	2530
SPC 2650	2680
SPC 2800	2830
SPC 3000	3030
SPC 3150	3180
SPC 3350	3380
SPC 3550	3580
SPC3750	3780
SPC 4000	4030
SPC 4250	4280
SPC 4400	4430
SPC 4500	4530
SPC 4750*	4780
SPC 5000*	5030
SPC 5300*	5330
SPC 5600*	5630
SPC 6000*	6030
SPC 6300*	6330
SPC 6700*	6730
SPC 7100*	7130
SPC 7500*	7530
SPC 8000*	8030
SPC 8500*	8530
SPC 9000*	9030
SPC 9500*	9530
SPC 10000*	10030
SPC 10600*	10630
SPC 11200*	11230
SPC 11800*	11830
SPC 12000*	12030
SPC 12500*	12530

* Available only in OLEOSTATIC version.

OLEOSTATIC

Rubber wrapped V-Belts

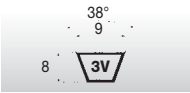

SECTION 3V*	
Code	External length LE(mm)
3V 250	635
3V 265	675
3V 280	710
3V 300	760
3V 315	800
3V 335	850
3V 355	900
3V 375	955
3V 400	1015
3V 425	1080
3V 450	1145
3V 475	1205
3V 500	1270
3V 530	1345
3V 560	1420
3V 600	1525
3V 630	1600
3V 670	1700
3V 710	1805
3V 750	1905
3V 800	2030
3V 850	2160
3V 900	2285
3V 950	2415
3V 1000	2540
3V 1060	2690
3V 1120	2845
3V 1180	2995
3V 1250	3175
3V 1320	3355
3V 1400	3555
3V 1500	3810

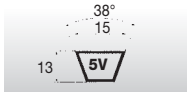

SECTION 5V*	
Code	External length LE (mm)
5V 500	1270
5V 530	1345
5V 560	1420
5V 600	1525
5V 630	1600
5V 670	1700
5V 710	1800
5V 750	1900
5V 800	2030
5V 850	2160
5V 900	2290
5V 950	2410
5V 1000	2540
5V 1060	2690
5V 1120	2840
5V 1180	3000
5V 1250	3180
5V 1320	3350
5V 1400	3550
5V 1500	3810
5V 1600	4060
5V 1700	4320
5V 1800	4570
5V 1900	4830
5V 2000	5080
5V 2120	5380
5V 2240	5690
5V 2360	6000
5V 2500	6350
5V 2650	6730
5V 2800	7100
5V 3000	7620
5V 3150	8000
5V 3350	8500
5V 3550	9000



SECTION 8V*	
Code	External length LE (mm)
8V 1000	2540
8V 1060	2690
8V 1120	2840
8V 1180	3000
8V 1250	3180
8V 1320	3350
8V 1400	3550
8V 1500	3810
8V 1600	4060
8V 1700	4320
8V 1800	4570
8V 1900	4830
8V 2000	5080
8V 2120	5380
8V 2240	5690
8V 2360	6000
8V 2500	6350
8V 2650	6730
8V 2800	7100
8V 3000	7620
8V 3150	8000
8V 3350	8500
8V 3550	9000
8V 3750	9500
8V 4000	10160
8V 4250	10800
8V 4500	11430
8V 4750	12060
8V 5000	12700



*Available only in OLEOSTATIC version.

ESAFLEX Rubber wrapped double V-Belts

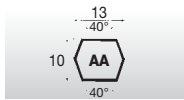
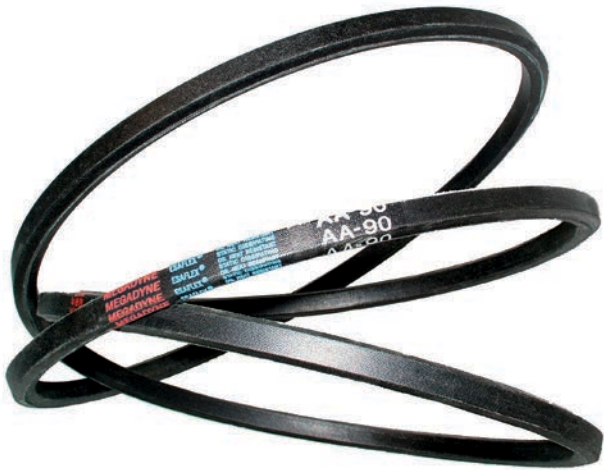
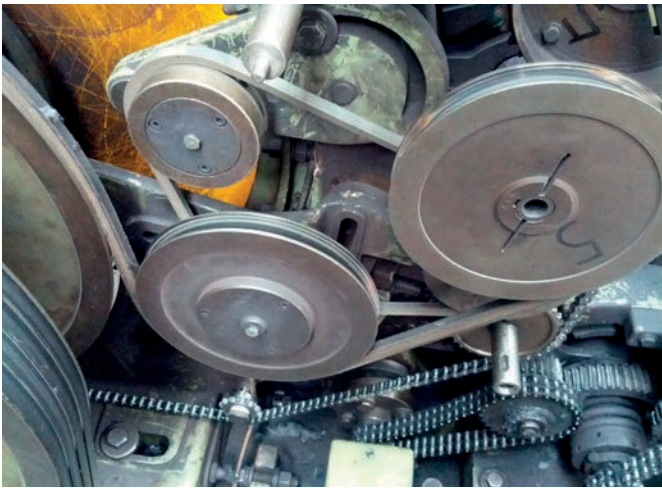

SECTION AA	
Code	Nominal length (mm)
AA 51	1350
AA 60	1580
AA 61	1600
AA 68	1780
AA 69	1805
AA 71	1855
AA 75	1955
AA 77	2010
AA 80	2085
AA 81	2110
AA 85	2210
AA 90	2340
AA 91	2365
AA 95	2465
AA 96	2490
AA 105	2720
AA 108	2800
AA 112	2895
AA 116	3000
AA 120	3100
AA 128	3305
AA 130	3355
AA 134	3455
AA 147	3785
AA 148	3810
AA 163	4195

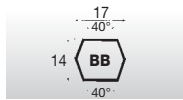

SECTION BB	
Code	Nominal length (mm)
BB 50	1345
BB 60	1600
BB 75	1980
BB 81	2130
BB 84	2210
BB 85	2235
BB 90	2360
BB 97	2540
BB 105	2745
BB 112	2920
BB 118	3075
BB 120	3125
BB 121	3150
BB 128	3325
BB 144	3735
BB 154	3990
BB 155	4015
BB 158	4090
BB 173	4470
BB 174	4495
BB 180	4650
BB 184	4750
BB 190	4900
BB 195	5030
BB 210	5410
BB 240	6135
BB 270	6895
BB 300	7660

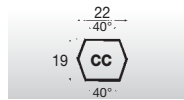

SECTION CC	
Code	Nominal length (mm)
CC 75	2010
CC 81	2160
CC 85	2265
CC 86	2290
CC 90	2390
CC 96	2545
CC 105	2770
CC 112	2950
CC 120	3150
CC 128	3355
CC 144	3760
CC 153	3990
CC 158	4120
CC 162	4220
CC 173	4500
CC 180	4680
CC 193	5010
CC 195	5060
CC 210	5440
CC 234	6000
CC 240	6155
CC 270	6910
CC 300	7675
CC 313	8000
CC 330	8435
CC 360	9200
CC 390	9960
CC 420	10720

XDV2

Rubber wrapped bare-back V-Belts



SECTION XDV2-38

Code	External length LE (inches)
XDV 38/150	15
XDV 38/160	16
XDV 38/170	17
XDV 38/180	18
XDV 38/190	19
XDV 38/200	20
XDV 38/210	21
XDV 38/220	22
XDV 38/230	23
XDV 38/240	24
XDV 38/250	25
XDV 38/260	26
XDV 38/270	27
XDV 38/280	28
XDV 38/290	29
XDV 38/300	30
XDV 38/310	31
XDV 38/320	32
XDV 38/330	33
XDV 38/340	34
XDV 38/350	35
XDV 38/360	36
XDV 38/370	37
XDV 38/380	38
XDV 38/390	39
XDV 38/400	40
XDV 38/410	41
XDV 38/420	42
XDV 38/430	43
XDV 38/440	44
XDV 38/450	45
XDV 38/460	46
XDV 38/470	47
XDV 38/480	48
XDV 38/490	49
XDV 38/500	50
XDV 38/510	51
XDV 38/520	52
XDV 38/530	53
XDV 38/540	54
XDV 38/550	55
XDV 38/560	56
XDV 38/570	57
XDV 38/580	58
XDV 38/590	59
XDV 38/600	60
XDV 38/610	61
XDV 38/620	62
XDV 38/630	63
XDV 38/690	69
XDV 38/710	71
XDV 38/740	74
XDV 38/750	75

SECTION XDV2-48

Code	External length LE (inches)
XDV 48/170	17
XDV 48/180	18
XDV 48/190	19
XDV 48/200	20
XDV 48/210	21
XDV 48/220	22
XDV 48/230	23
XDV 48/240	24
XDV 48/250	25
XDV 48/260	26
XDV 48/270	27
XDV 48/280	28
XDV 48/290	29
XDV 48/300	30
XDV 48/310	31
XDV 48/320	32
XDV 48/330	33
XDV 48/340	34
XDV 48/350	35
XDV 48/360	36
XDV 48/370	37
XDV 48/380	38
XDV 48/390	39
XDV 48/400	40
XDV 48/410	41
XDV 48/420	42
XDV 48/430	43
XDV 48/440	44
XDV 48/450	45
XDV 48/460	46
XDV 48/470	47
XDV 48/480	48
XDV 48/490	49
XDV 48/500	50
XDV 48/510	51
XDV 48/520	52
XDV 48/530	53
XDV 48/540	54
XDV 48/550	55
XDV 48/560	56
XDV 48/570	57
XDV 48/580	58
XDV 48/590	59
XDV 48/600	60
XDV 48/610	61
XDV 48/620	62
XDV 48/630	63
XDV 48/640	64
XDV 48/650	65
XDV 48/660	66
XDV 48/670	67
XDV 48/680	68
XDV 48/690	69
XDV 48/700	70
XDV 48/710	71
XDV 48/720	72
XDV 48/730	73
XDV 48/740	74
XDV 48/750	75
XDV 48/760	76
XDV 48/770	77
XDV 48/780	78
XDV 48/790	79
XDV 48/800	80
XDV 48/810	81
XDV 48/820	82
XDV 48/830	83
XDV 48/840	84
XDV 48/850	85
XDV 48/860	86
XDV 48/870	87
XDV 48/880	88
XDV 48/890	89
XDV 48/900	90
XDV 48/910	91
XDV 48/920	92
XDV 48/930	93
XDV 48/940	94
XDV 48/950	95
XDV 48/960	96
XDV 48/970	97
XDV 48/980	98
XDV 48/990	99
XDV 48/1000	100
XDV 48/1050	105
XDV 48/1070	107
XDV 48/1140	114
XDV 48/1170	117

SECTION XDV2-58

Code	External length LE (inches)
XDV 58/230	23
XDV 58/240	24
XDV 58/250	25
XDV 58/260	26
XDV 58/270	27
XDV 58/280	28
XDV 58/290	29
XDV 58/300	30
XDV 58/310	31
XDV 58/320	32
XDV 58/330	33
XDV 58/340	34
XDV 58/350	35
XDV 58/360	36
XDV 58/370	37
XDV 58/380	38
XDV 58/390	39
XDV 58/400	40
XDV 58/410	41
XDV 58/420	42
XDV 58/430	43
XDV 58/440	44
XDV 58/450	45
XDV 58/460	46
XDV 58/470	47
XDV 58/480	48
XDV 58/490	49
XDV 58/500	50
XDV 58/510	51
XDV 58/520	52
XDV 58/530	53
XDV 58/540	54
XDV 58/550	55
XDV 58/560	56
XDV 58/570	57
XDV 58/580	58
XDV 58/590	59
XDV 58/600	60
XDV 58/610	61
XDV 58/620	62
XDV 58/630	63
XDV 58/640	64
XDV 58/650	65
XDV 58/660	66
XDV 58/670	67
XDV 58/680	68
XDV 58/690	69
XDV 58/700	70
XDV 58/710	71
XDV 58/720	72
XDV 58/730	73
XDV 58/740	74
XDV 58/750	75
XDV 58/760	76
XDV 58/770	77
XDV 58/780	78
XDV 58/790	79
XDV 58/800	80
XDV 58/810	81
XDV 58/820	82
XDV 58/830	83
XDV 58/840	84
XDV 58/850	85
XDV 58/860	86
XDV 58/870	87
XDV 58/880	88
XDV 58/890	89
XDV 58/900	90
XDV 58/910	91
XDV 58/920	92
XDV 58/930	93
XDV 58/940	94
XDV 58/950	95
XDV 58/960	96
XDV 58/970	97
XDV 58/980	98
XDV 58/990	99
XDV 58/1000	100
XDV 58/1030	103
XDV 58/1080	108



PLURIBAND Rubber banded V-Belts

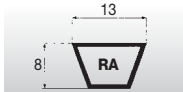

SECTION RA	
Code	Internal length LI (mm)
RA 47	1200
RA 51	1300
RA 56	1422
RA 57	1450
RA 59	1500
RA 64	1625
RA 67	1700
RA 71	1800
RA 75	1900
RA 79	2000
RA 88	2240
RA 98	2500
RA 100	2540
RA 104	2650
RA 112	2845
RA 120	3048
RA 128	3250
RA 144	3658
RA 158	4000
RA 167	4250
RA 187	4750
RA 197	5000
RA 210	5334
RA 217	5477

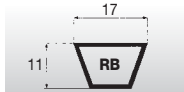

SECTION RB	
Code	Internal length LI (mm)
RB 70	1778
RB 71	1803
RB 72	1829
RB 73	1854
RB 74	1880
RB 75	1905
RB 76	1930
RB 78	1981
RB 79	2007
RB 80	2032
RB 81	2057
RB 82	2083
RB 83	2108
RB 84	2134
RB 85	2159
RB 86	2184
RB 87	2210
RB 88	2235
RB 89	2261
RB 90	2286
RB 91	2311
RB 92	2337
RB 93	2362
RB 94	2388
RB 95	2413
RB 96	2438
RB 97	2464
RB 98	2489
RB 99	2515
RB 100	2540
RB 102	2591
RB 104	2642
RB 105	2667
RB 106	2692
RB 107	2718
RB 108	2743
RB 110	2794
RB 112	2845
RB 114	2896
RB 115	2921
RB 116	2946
RB 118	2997
RB 120	3048
RB 124	3150
RB 127	3226
RB 128	3251
RB 130	3302
RB 131	3327
RB 132	3353
RB 133	3378
RB 134	3404
RB 135	3429
RB 136	3454
RB 140	3556
RB 144	3658
RB 147	3734
RB 148	3759
RB 151	3835
RB 152	3861
RB 154	3912
RB 157	3988
RB 158	4013
RB 161	4089
RB 162	4115
RB 163	4140
RB 165	4191
RB 167	4242
RB 168	4267
RB 173	4394
RB 175	4445
RB 177	4496
RB 180	4572
RB 186	4724
RB 188	4775
RB 192	4877
RB 195	4953
RB 197	5004

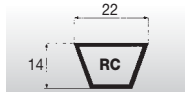

SECTION RC	
Code	Internal length LI (mm)
RC 98	2489
RC 99	2515
RC 100	2540
RC 101	2565
RC 102	2591
RC 104	2642
RC 105	2667
RC 106	2692
RC 108	2743
RC 110	2794
RC 112	2845
RC 115	2921
RC 118	2997
RC 120	3048
RC 124	3150
RC 128	3251
RC 130	3302
RC 134	3404
RC 136	3454
RC 140	3556
RC 142	3607
RC 144	3658
RC 148	3759
RC 153	3886
RC 158	4013
RC 160	4064
RC 165	4191
RC 166	4216
RC 168	4267
RC 173	4394
RC 180	4572
RC 195	4953
RC 210	5334

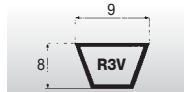

SECTION R3V	
Code	Nominal external length (mm)
R3V 335	850
R3V 355	900
R3V 375	950
R3V 400	1015
R3V 425	1080
R3V 450	1145
R3V 475	1205
R3V 500	1270
R3V 530	1345
R3V 560	1420
R3V 600	1525
R3V 630	1600
R3V 670	1700
R3V 710	1800
R3V 750	1900
R3V 800	2030
R3V 850	2160
R3V 900	2290
R3V 950	2410
R3V 1000	2540
R3V 1060	2690
R3V 1120	2840
R3V 1180	3000
R3V 1250	3180
R3V 1320	3350
R3V 1400	3550

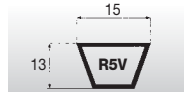

SECTION R5V	
Code	Nominal external length (mm)
R5V 500	1270
R5V 530	1345
R5V 560	1420
R5V 600	1525
R5V 630	1600
R5V 670	1700
R5V 710	1800
R5V 750	1900
R5V 800	2030
R5V 850	2160
R5V 900	2290
R5V 950	2410
R5V 1000	2540
R5V 1120	2840
R5V 1180	3000
R5V 1250	3180
R5V 1320	3350
R5V 1400	3550
R5V 1500	3810
R5V 1600	4060
R5V 1700	4320
R5V 1800	4570
R5V 1900	4830
R5V 2000	5080
R5V 2120	5380
R5V 2240	5690
R5V 2360	6000
R5V 2500	6350
R5V 2650	6730
R5V 2800	7100
R5V 3000	7620
R5V 3150	8000
R5V 3350	8500
R5V 3550	9000

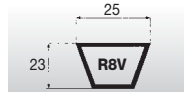

SECTION R8V	
Code	Nominal external length (mm)
R8V 1000	2540
R8V 1060	2690
R8V 1120	2840
R8V 1180	3000
R8V 1250	3180
R8V 1320	3350
R8V 1400	3550
R8V 1500	3810
R8V 1600	4060
R8V 1700	4320
R8V 1800	4570
R8V 1900	4830
R8V 2000	5080
R8V 2120	5380
R8V 2240	5690
R8V 2360	6000
R8V 2500	6350
R8V 2650	6730
R8V 2800	7100
R8V 3000	7620
R8V 3150	8000
R8V 3350	8500
R8V 3550	9000
R8V 3750	9500
R8V 4000	10160
R8V 4250	10800
R8V 4500	11430
R8V 4750	12060
R8V 5000	12700
R8V 5600	14200
R8V 6000	15250

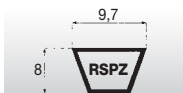

SECTION RSPZ	
Code	Pitch length LW (mm)
RSPZ 1400	1400
RSPZ 1500	1500
RSPZ 1600	1600
RSPZ 1700	1700
RSPZ 1800	1800
RSPZ 1900	1900
RSPZ 2000	2000
RSPZ 2120	2120
RSPZ 2240	2240
RSPZ 2360	2360
RSPZ 2500	2500
RSPZ 2650	2650
RSPZ 2800	2800
RSPZ 3000	3000
RSPZ 3150	3150
RSPZ 3350	3350
RSPZ 3550	3550

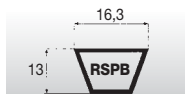

SECTION RSPB	
Code	Pitch length LW (mm)
RSPB 2000	2000
RSPB 2120	2120
RSPB 2240	2240
RSPB 2360	2360
RSPB 2500	2500
RSPB 2650	2650
RSPB 2800	2800
RSPB 3000	3000
RSPB 3150	3150
RSPB 3350	3350
RSPB 3750	3750
RSPB 4000	4000
RSPB 4250	4250
RSPB 4500	4500
RSPB 4750	4750
RSPB 5000	5000
RSPB 5300	5300
RSPB 5600	5600
RSPB 6000	6000
RSPB 6300	6300
RSPB 6700	6700
RSPB 7100	7100
RSPB 7500	7500
RSPB 8000	8000

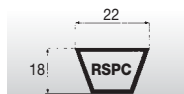

SECTION RSPC	
Code	Pitch length LW (mm)
RSPC 3000	3000
RSPC 3150	3150
RSPC 3350	3350
RSPC 3550	3550
RSPC 3750	3750
RSPC 4000	4000
RSPC 4250	4250
RSPC 4500	4500
RSPC 4750	4750
RSPC 5000	5000
RSPC 5300	5300
RSPC 5600	5600
RSPC 6000	6000
RSPC 6300	6300
RSPC 6700	6700
RSPC 7100	7100
RSPC 7500	7500
RSPC 8000	8000
RSPC 8500	8500
RSPC 9000	9000
RSPC 9500	9500
RSPC 10000	10000
RSPC 10600	10600
RSPC 11200	11200
RSPC 11800	11800
RSPC 12500	12500



SECTION R3VX	
Code	Nominal external length (mm)
R3VX 250	630
R3VX 265	670
R3VX 280	710
R3VX 300	760
R3VX 315	800
R3VX 335	850
R3VX 355	900
R3VX 375	950
R3VX 400	1015
R3VX 425	1080
R3VX 450	1145
R3VX 475	1205
R3VX 500	1270
R3VX 530	1345
R3VX 560	1420
R3VX 600	1525
R3VX 630	1600
R3VX 670	1700
R3VX 710	1800
R3VX 750	1900
R3VX 800	2030
R3VX 850	2160
R3VX 900	2290
R3VX 950	2410
R3VX 1000	2540
R3VX 1060	2690
R3VX 1120	2840
R3VX 1180	3000
R3VX 1250	3180
R3VX 1320	3350
R3VX 1400	3550

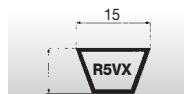

SECTION R5VX	
Code	Nominal external length (mm)
R5VX 500	1270
R5VX 530	1345
R5VX 560	1420
R5VX 600	1525
R5VX 630	1600
R5VX 670	1700
R5VX 710	1800
R5VX 800	2030
R5VX 850	2160
R5VX 900	2290
R5VX 950	2410
R5VX 1000	2540
R5VX 1060	2690
R5VX 1120	2840
R5VX 1180	3000
R5VX 1250	3180
R5VX 1320	3350
R5VX 1400	3550
R5VX 1500	3810
R5VX 1600	4060
R5VX 1700	4320
R5VX 1800	4570
R5VX 1900	4830
R5VX 2000	5080

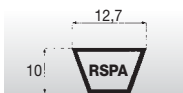

SECTION RSPA	
Code	Pitch length LW (mm)
RSPA 1400	1400
RSPA 1500	1500
RSPA 1600	1600
RSPA 1700	1700
RSPA 1800	1800
RSPA 1900	1900
RSPA 2000	2000
RSPA 2120	2120
RSPA 2240	2240
RSPA 2360	2360
RSPA 2500	2500
RSPA 2650	2650
RSPA 2800	2800
RSPA 3000	3000
RSPA 3150	3150
RSPA 3350	3350
RSPA 3550	3550
RSPA 3750	3750
RSPA 4000	4000
RSPA 4250	4250
RSPA 4500	4500



CONTRAFOR Rubber wrapped open-end V-Belts

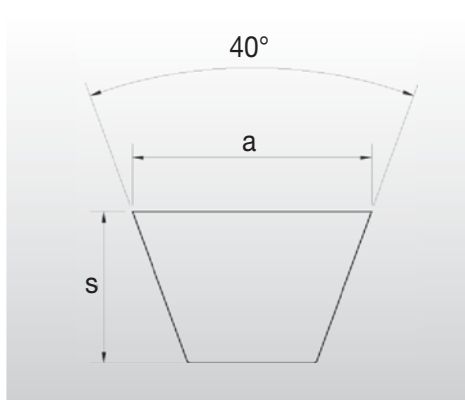

SECTION	a (mm)	s (mm)
10/Z	10	6
13/A	13	8
17/B	17	11
22/C	22	14

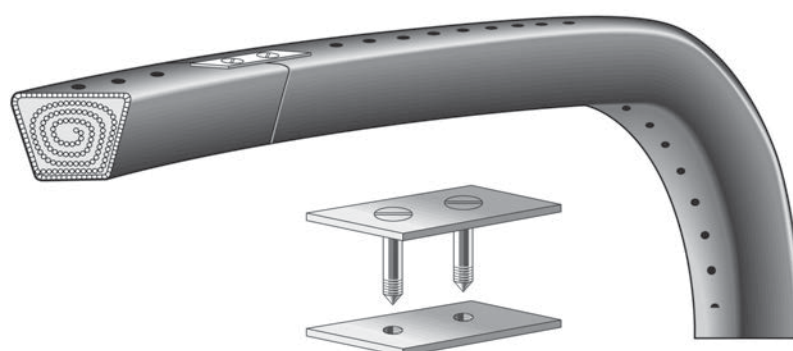
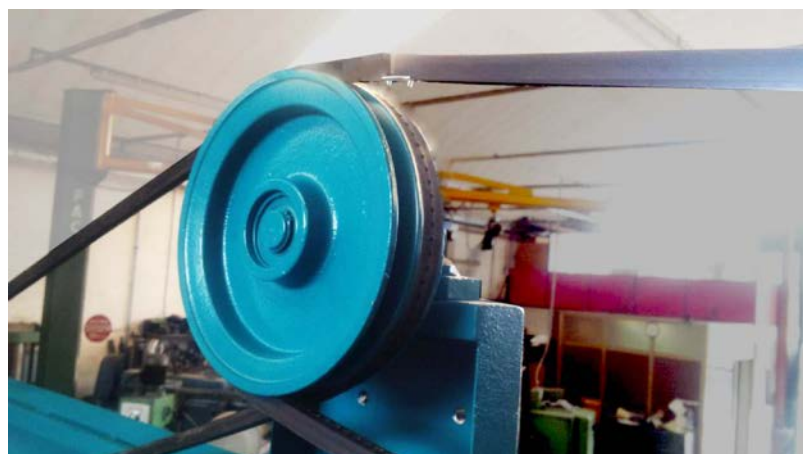

ACCU-LINK Urethane adjustable V-Belts

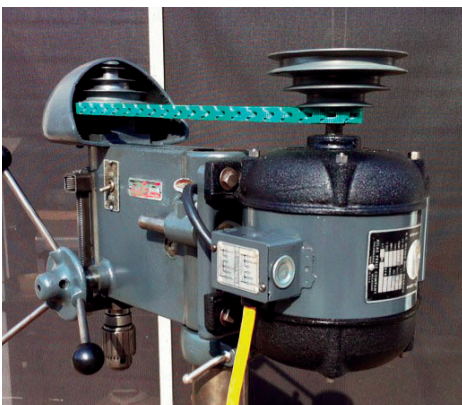

Accu-Link adjustable V-Belts are the ideal replacement substitute for conventional rubber V-Belts.

Solve V-Belt drive problems quickly, accurately & permanently, the ideal temporary replacement or permanent substitute for conventional rubber V-Belts, Accu-Link V-Belts combine superior strength, durability and quick, easy assembly to keep equipment up and running at the same running horse power ratings as rubber belts.

Constructed of urethane elastomer reinforced with a rugged, woven polyester fabric, Accu-Link V-belts are manufactured by a revolutionary new process which creates smooth, precise side profiles on each link. This smooth profile creates less vibration and requires lower drive tensions for increased belt life. Designed to any drive application, Accu-Link V-belts are available in the most popular sizes: Z/3L A/4L, B/5L, and C sections in roll and sleeve.

What's more, Accu-Link V-belts maintain precise tension, so they deliver maximum power on multiple-belt drives.

- Durable urethane coating Precision machined sides for smooth engagement
- Rugged, woven polyester fabric for strength and longer belt life.
- Accu-Link cross section ideal for diverse operating environments
- Accu-Link V-belt urethane construction offers superior resistance to most common industrial solvents and chemicals, oil, water and extreme temperatures, from -25°C to 80°C.
- Accu-Link V-belts dissipate heat so they run cooler than conventional belts.

Installation is a snap installation and assembly is as easy as a snap and a twist.

No special tools are required to couple or uncouple each Accu-Link V-Belt. Belts can be made to accommodate any length, which makes them ideal for emergency repairs and replacements. Once assembled, Accu-Link V-Belts are installed in a fraction of the time needed for endless rubber belts. Accu-Link V-Belts are installed in minutes without removing outboard bearings or moving motors.

Suited to harsh environments, Accu-Link V-belts are ideal for the metal processing, machine tool, agricultural, packaging, coal and aggregate, pulp and paper, lumber, marine, air moving, petrochemical, woodworking, conveying and food industries, HVAC.

Choose Accu-Link For:

- Durability
- Easy Assembly
- Fast Installation
- Maximum Horsepower
- Dependability

	RANGE			
	Z/3L	A/4L	B/5L	C
5' SLEEVE	X	X		X
6'SLEEVE		X	X	
25' ROLL	X	X	X	X
50' ROLL				X
100' ROLL	X	X	X	

GOLD LABEL - LINEA-X - VARISECT
Rubber raw edge V-Belts

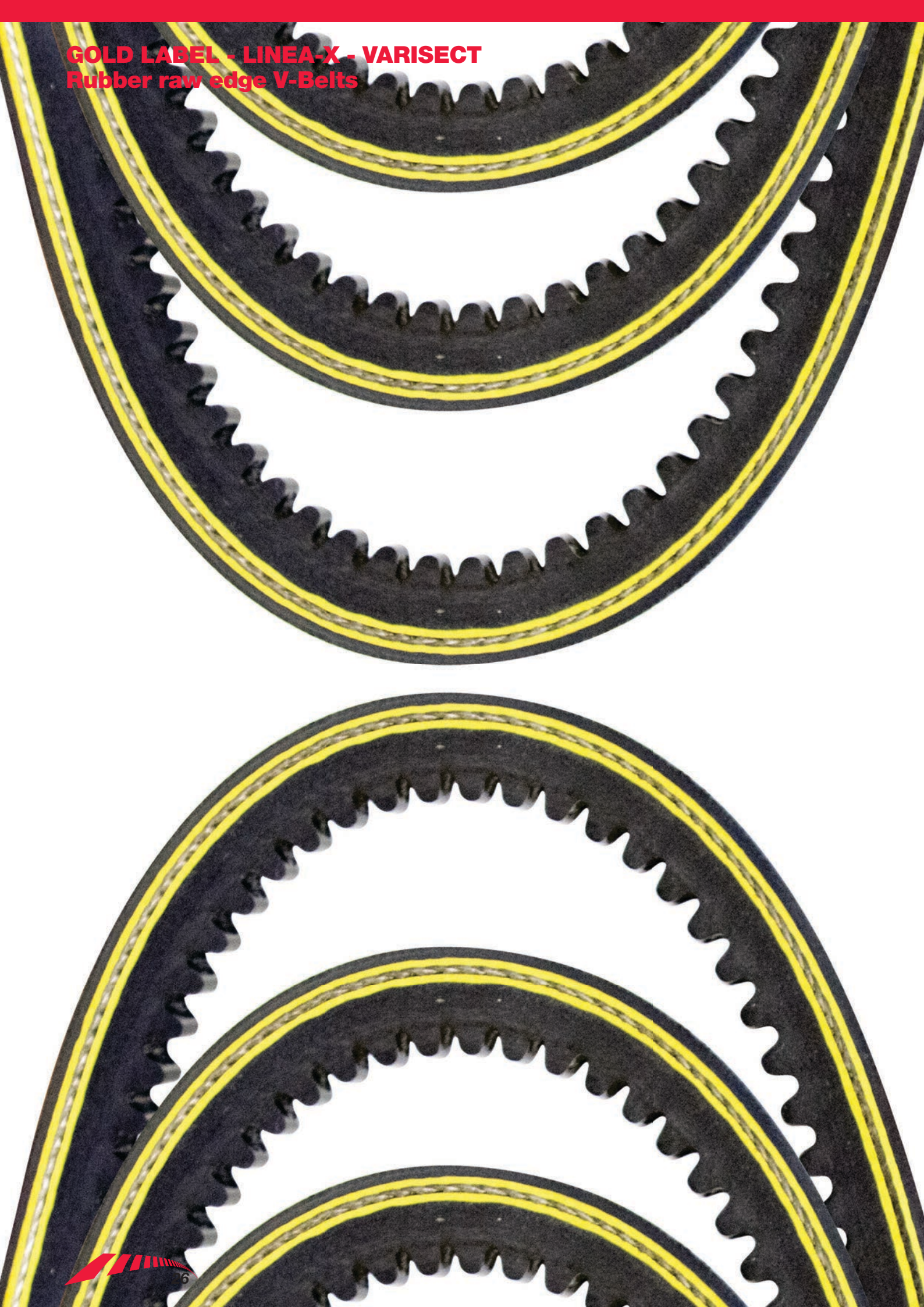

LINEA-X - LINEA GOLD Rubber raw edge V-Belts

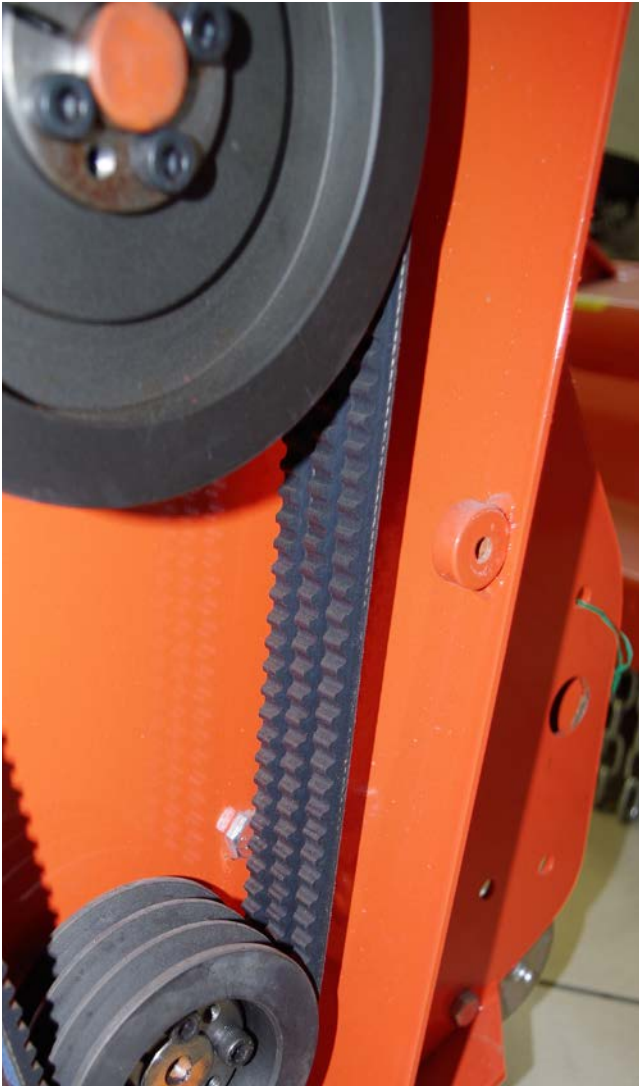

LINEA-X

These belts have been specifically developed to run where small pulley diameters and high transmission ratios put a limit to the use of wrapped belts of the same section. Compared to wrapped belts, LINEA-X family has important improvements, like specific compounds and special production technology. In particular the transverse orientation of the fibers improves the cord support capacity of the body section and reinforces its transverse rigidity, while maintaining, (due to the cogged profile and the precision-ground sidewalls) the highest longitudinal flexibility and running stability. These characteristics guarantee an excellent structure with advantages such as: high transmission ratios, improved grip and resistance to continuous bending.

LINEA GOLD

The NEW generation of raw edge belts.

New materials, advanced design features and an innovative production process has led MEGADYNE to develop a new generation of raw edge V-belt drives that outperform, in a wide range of industrial applications, all the previous drives equipped with standard raw edge belts, granting large cost advantages for the end users and greater design flexibility for the engineers. The belt has a narrow cross section and a raw edge construction, based on a new EPDM rubber compound which can withstand chemically aggressive environments, ageing, ozone, UV and heat.

Special constructions and laminated belts are available on request.

MEGAMATCH MEGA MATCH

All Linea Gold and Linea-X V-belts carrying the MEGA MATCH logo are made and supplied according to the matching set tolerances and limits indicated by the relevant international standards (ISO, RMA, etc)



LINEA GOLD

Rubber raw edge V-Belts

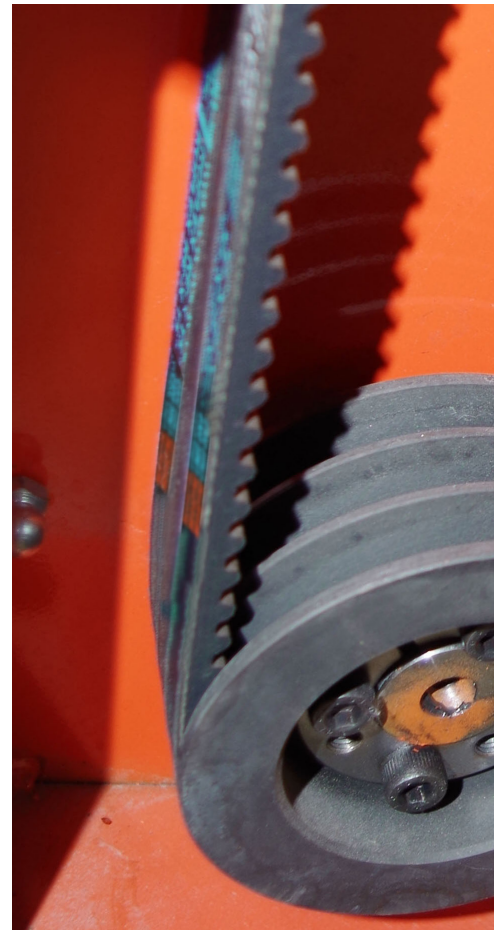
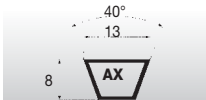

SECTION AX	
Code	External length LE (mm)
AX 21	585
AX 22	610
AX 23	635
AX 24	665
AX 25	690
AX 26	710
AX 27	750
AX 28	765
AX 29	800
AX 30	815
AX 31	850
AX 32	865
AX 33	900
AX 34	915
AX 35	950
AX 36	965
AX 37	1000
AX 38	1020
AX 39	1045
AX 40	1075
AX 41	1095
AX 42	1120
AX 43	1150
AX 44	1170
AX 45	1195
AX 46	1230
AX 47	1245
AX 48	1270
AX 49	1300
AX 50	1325
AX 51	1350
AX 52	1375
AX 53	1400
AX 54	1425
AX 55	1450
AX 56	1475
AX 57	1500
AX 58	1525
AX 59	1550
AX 60	1585
AX 61	1600
AX 62	1630
AX 63	1655
AX 64	1680
AX 65	1710
AX 66	1730
AX 67	1760
AX 68	1790
AX 69	1810
AX 70	1830
AX 71	1865
AX 72	1890
AX 73	1905
AX 74	1935
AX 75	1965
AX 76	1985
AX 77	2010
AX 78	2030
AX 79	2060
AX 80	2080
AX 81	2120
AX 82	2140
AX 83	2160
AX 84	2190
AX 85	2220
AX 86	2240
AX 87	2260
AX 88	2290
AX 89	2310
AX 90	2350
AX 91	2360
AX 92	2390
AX 93	2420
AX 94	2440
AX 95	2470
AX 96	2500
AX 97	2520
AX 98	2540
AX 100	2600
AX 103	2670
AX 105	2730
AX 110	2850
AX 112	2910
AX 120	3110
AX 128	3310
AX 136	3510
AX 144	3710
AX 158	4070
AX 173	4450
AX 180	4620

SECTION BX	
Code	External length LE (mm)
BX 28	785
BX 32	885
BX 34	935
BX 35	960
BX 36	990
BX 38	1040
BX 40	1090
BX 41	1120
BX 42	1140
BX 43	1165
BX 44	1190
BX 45	1215
BX 46	1250
BX 47	1265
BX 48	1295
BX 49	1320
BX 50	1345
BX 51	1370
BX 52	1400
BX 53	1420
BX 54	1445
BX 55	1470
BX 56	1500
BX 57	1520
BX 58	1545
BX 59	1570
BX 60	1600
BX 61	1625
BX 62	1650
BX 63	1675
BX 64	1700
BX 65	1725
BX 66	1750
BX 67	1775
BX 68	1800
BX 69	1825
BX 70	1850
BX 71	1875
BX 72	1900
BX 73	1930
BX 74	1955
BX 75	1980
BX 76	2000
BX 77	2030
BX 78	2050
BX 79	2080

SECTION BX	
Code	External length LE (mm)
BX 80	2110
BX 81	2130
BX 82	2160
BX 83	2180
BX 84	2210
BX 85	2240
BX 86	2260
BX 87	2280
BX 88	2310
BX 89	2330
BX 90	2360
BX 91	2390
BX 92	2410
BX 93	2440
BX 94	2460
BX 95	2500
BX 96	2510
BX 97	2540
BX 98	2560
BX 99	2590
BX 100	2620
BX 103	2690
BX 105	2740
BX 106	2770
BX 108	2820
BX 112	2920
BX 113	2940
BX 115	2990
BX 116	3020
BX 120	3130
BX 123	3200
BX 124	3220
BX 126	3270
BX 128	3330
BX 133	3450
BX 136	3530
BX 140	3630
BX 144	3740
BX 148	3830
BX 150	3880
BX 154	3990
BX 158	4090
BX 162	4200
BX 173	4480
BX 180	4650
BX 191	4930
BX 195	5040

SECTION CX	
Code	External length LE (mm)
CX 51	1400
CX 55	1500
CX 60	1630
CX 68	1830
CX 72	1935
CX 75	2000
CX 78	2090
CX 81	2160
CX 85	2270
CX 90	2390
CX 96	2540
CX 100	2650
CX 101	2670
CX 105	2770
CX 109	2870
CX 111	2920
CX 112	2950
CX 115	3030
CX 120	3150
CX 128	3350
CX 136	3550
CX 144	3760
CX 148	3860
CX 150	3920
CX 158	4120
CX 162	4220
CX 173	4500
CX 180	4680



LINEA-X - LINEA GOLD

Rubber raw edge V-Belts



SECTION XPZ	
Code	External length (mm)
XPZ512	525
XPZ562	575
XPZ587	600
XPZ607	620
XPZ612	625
XPZ630	643
XPZ637	650
XPZ662	675
XPZ670	683
XPZ687	700
XPZ710	723
XPZ722	735
XPZ730	743
XPZ737	750
XPZ750	763
XPZ762	775
XPZ772	785
XPZ787	800
XPZ800	813
XPZ812	825
XPZ837	850
XPZ850	863
XPZ852	865
XPZ862	875
XPZ875	888
XPZ887	900
XPZ900	913
XPZ912	925
XPZ925	938
XPZ937	950
XPZ940	953
XPZ950	963
XPZ962	975
XPZ975	988
XPZ987	1000
XPZ1000	1013
XPZ1012	1025
XPZ1024	1037
XPZ1030	1043
XPZ1037	1050
XPZ1047	1060
XPZ1060	1073
XPZ1062	1075
XPZ1077	1090
XPZ1080	1093
XPZ1087	1100
XPZ1112	1125
XPZ1120	1133
XPZ1137	1150
XPZ1162	1175
XPZ1180	1193
XPZ1187	1200
XPZ1202	1215
XPZ1212	1225
XPZ1237	1250
XPZ1250	1263
XPZ1262	1275
XPZ1270	1283
XPZ1280	1293
XPZ1287	1300
XPZ1312	1325
XPZ1320	1333
XPZ1337	1350
XPZ1362	1375
XPZ1387	1400
XPZ1400	1413
XPZ1412	1425
XPZ1420	1433
XPZ1437	1450
XPZ1462	1475
XPZ1470	1483
XPZ1487	1500
XPZ1500	1513
XPZ1512	1525
XPZ1520	1533
XPZ1537	1550
XPZ1562	1575
XPZ1587	1600
XPZ1600	1613
XPZ1612	1625
XPZ1637	1650
XPZ1650	1663
XPZ1662	1675
XPZ1700	1713
XPZ1737	1750
XPZ1750	1763
XPZ1762	1775
XPZ1800	1813
XPZ1812	1825
XPZ1850	1863



SECTION XPZ	
Code	External length (mm)
XPZ1862	1875
XPZ1887	1900
XPZ1900	1913
XPZ1937	1950
XPZ1950	1963
XPZ2000	2013
XPZ2030	2043
XPZ2037	2050
XPZ2120	2133
XPZ2160	2173
XPZ2240	2253
XPZ2280	2293
XPZ2360	2373
XPZ2410	2423
XPZ2500	2513
XPZ2540	2553
XPZ2650	2663
XPZ2690	2703
XPZ2800	2813
XPZ2840	2853
XPZ3000	3013
XPZ3150	3163
XPZ3170	3183
XPZ3350	3363
XPZ3550	3563



SECTION 3VX	
Code	External length (mm)
3VX 250	630
3VX 265	670
3VX 280	710
3VX 300	760
3VX 315	800
3VX 335	850
3VX 355	900
3VX 375	950
3VX 400	1015
3VX 425	1080
3VX 450	1145
3VX 475	1205
3VX 500	1270
3VX 530	1345
3VX 560	1420
3VX 600	1525
3VX 630	1600
3VX 670	1700
3VX 710	1800
3VX 750	1900
3VX 800	2030
3VX 850	2160
3VX 900	2290
3VX 950	2410
3VX 1000	2540
3VX 1060	2690
3VX 1120	2840
3VX 1180	3000
3VX 1250	3180
3VX 1320	3350
3VX 1400	3550
3VX 1500	3810

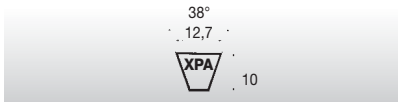

SECTION XPA	
Code	External length (mm)
XPA667	685
XPA682	700
XPA732	750
XPA757	775
XPA782	800
XPA800	818
XPA807	825
XPA832	850
XPA850	868
XPA857	875
XPA882	900
XPA900	918
XPA907	925
XPA925	943
XPA932	950
XPA950	968
XPA957	975
XPA969	987
XPA982	1000
XPA1000	1018
XPA1007	1025
XPA1032	1050
XPA1057	1075
XPA1060	1078
XPA1082	1100
XPA1107	1125
XPA1120	1138
XPA1132	1150
XPA1150	1168
XPA1157	1175
XPA1162	1675
XPA1180	1198
XPA1182	1200
XPA1207	1225
XPA1232	1250
XPA1250	1268
XPA1257	1275
XPA1272	1290
XPA1282	1300
XPA1307	1325
XPA1320	1338
XPA1332	1350
XPA1357	1375
XPA1382	1400
XPA1400	1418
XPA1407	1425
XPA1420	1438
XPA1432	1450
XPA1450	1468
XPA1457	1475
XPA1482	1500
XPA1500	1518

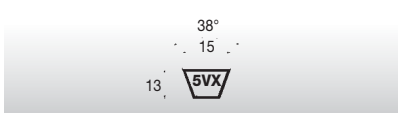

SECTION 5VX	
Code	External length (mm)
5VX 450	1150
5VX 470	1190
5VX 490	1250
5VX 500	1270
5VX 510	1290
5VX 530	1345
5VX 540	1370
5VX 550	1400
5VX 560	1420
5VX 570	1450
5VX 580	1470
5VX 590	1500
5VX 600	1525
5VX 610	1550
5VX 630	1600
5VX 650	1650
5VX 660	1680
5VX 670	1700
5VX 680	1730
5VX 690	1750
5VX 710	1800
5VX 730	1850
5VX 740	1880
5VX 750	1900
5VX 780	1980
5VX 800	2030
5VX 810	2060

SECTION XPA	
Code	External length (mm)
XPA1507	1525
XPA1532	1550
XPA1557	1575
XPA1582	1600
XPA1600	1618
XPA1607	1625
XPA1632	1650
XPA1650	1668
XPA1682	1700
XPA1700	1718
XPA1732	1750
XPA1757	1775
XPA1782	1800
XPA1800	1818
XPA1832	1850
XPA1850	1868
XPA1900	1918
XPA1932	1950
XPA1950	1968
XPA1957	1975
XPA1982	2000
XPA2000	2018
XPA2032	2050
XPA2057	2075
XPA2082	2100
XPA2120	2138
XPA2160	2178
XPA2182	2200
XPA2240	2258
XPA2282	2300
XPA2300	2318
XPA2360	2378
XPA2432	2450
XPA2482	2500
XPA2500	2518
XPA2532	2550
XPA2582	2600
XPA2607	2625
XPA2632	2650
XPA2650	2668
XPA2682	2700
XPA2732	2750
XPA2782	2800
XPA2800	2818
XPA3000	3018
XPA3150	3168
XPA3350	3368
XPA3550	3568
XPA3750	3768
XPA4000	4018
XPA4250	4268
XPA4500	4518

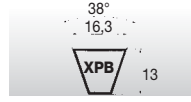

SECTION XPB	
Code	External length (mm)
XPB1250	1272
XPB1260	1282
XPB1320	1342
XPB1340	1362
XPB1400	1422
XPB1410	1432
XPB1450	1472
XPB1500	1522
XPB1510	1532
XPB1590	1612
XPB1600	1622
XPB1650	1672
XPB1690	1712
XPB1700	1722
XPB1750	1772
XPB1800	1822
XPB1850	1872
XPB1900	1922
XPB1950	1972
XPB1970	1982
XPB2000	2022
XPB2020	2042
XPB2060	2082
XPB2120	2142
XPB2150	2172
XPB2180	2202
XPB2240	2262
XPB2280	2302
XPB2300	2322
XPB2360	2382
XPB2410	2432
XPB2430	2452
XPB2500	2522
XPB2530	2552
XPB2580	2602
XPB2650	2672
XPB2680	2702
XPB2800	2822
XPB2840	2862
XPB2900	2922
XPB2990	3012
XPB3000	3022
XPB3070	3092
XPB3150	3172
XPB3170	3192
XPB3340	3362
XPB3350	3372
XPB3550	3572
XPB3750	3772
XPB3800	3822
XPB4000	4022
XPB4060	4082
XPB4250	4272
XPB4500	4522
XPB4560	4582
XPB4750	4772
XPB5000	5022

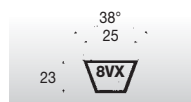

SECTION 8VX	
Code	External length (mm)
8VX 1000	2540
8VX 1060	2690
8VX 1120	2840
8VX 1180	3000
8VX 1250	3180
8VX 1320	3350
8VX 1400	3550
8VX 1500	3810
8VX 1600	4060
8VX 1700	4320
8VX 1800	4570
8VX 1900	4830
8VX 2000	5080

VARISECT

Rubber variable speed belts

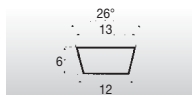

SECTION 13x6	
Code	Pitch length LI (mm)
425	425
500	500
525	525
555	555
650	650
675	675
700	700
725	725
750	750
775	775
900	900

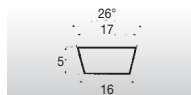

SECTION 17x6 W16	
Code	Nominal pitch length (mm)
W 16P	450
W 16P	500
W 16P	560
W 16P	600
W 16P	630
W 16P	710
W 16P	800
W 16P	900
W 16P	1000

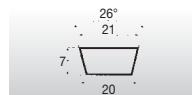

SECTION 21x7 W20	
Code	Nominal pitch length (mm)
W 20P	560
W 20P	630
W 20P	640
W 20P	710
W 20P	800
W 20P	900
W 20P	1000
W 20P	1120
W 20P	1250

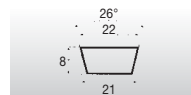

SECTION 22x8	
Code	Pitch length LI (mm)
500	500
525	525
550	550
575	575
600	600
610	610
625	625
650	650
675	675
700	700
725	725
750	750
800	800
850	850
900	900
950	950
1000	1000
1060	1060
1120	1120
1180	1180
1250	1250
1320	1320
1400	1400
1500	1500
1600	1600
2000	2000

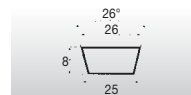

SECTION 26x8 W25	
Code	Nominal pitch length (mm)
W 25P	560
W 25P	690
W 25P	710
W 25P	750
W 25P	790
W 25P	800
W 25P	900
W 25P	1000
W 25P	1120
W 25P	1250
W 25P	1400
W 25P	1613

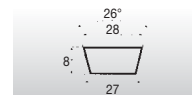

SECTION 28X8	
Code	Pitch length LI (mm)
525	525
600	600
625	625
650	650
700	700
750	750
800	800
850	850
900	900
950	950
1000	1000
1060	1060
1120	1120
1180	1180
1250	1250
1320	1320
1400	1400
1500	1500
1600	1600
1700	1700

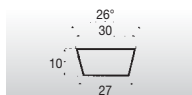

SECTION 30x10	
Code	Pitch length LI (mm)
650	650
665	665
700	700
800	800
850	850
875	875
900	900
950	950
1000	1000
1035	1035
1050	1050
1120	1120
1200	1200
1320	1320
1340	1340
1500	1500
1600	1600

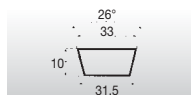

SECTION 32x10 W31,5	
Code	Nominal pitch length (mm)
W 31,5P	800
W 31,5P	840
W 31,5P	870
W 31,5P	900
W 31,5P	950
W 31,5P	1000
W 31,5P	1050
W 31,5P	1120
W 31,5P	1250
W 31,5P	1400
W 31,5P	1600
W 31,5P	1800
W 31,5P	2000

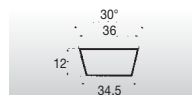

SECTION 36x12	
Code	Pitch length LI (mm)
700	700
725	725
800	800
850	850
900	900
950	950
1000	1000
1060	1060
1120	1120
1180	1180
1250	1250
1320	1320
1400	1400
1500	1500
1600	1600
1700	1700
1800	1800
2000	2000
2120	2120

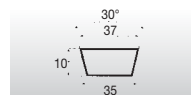

SECTION 37x10	
Code	Pitch length LI (mm)
600	600
650	650
675	675
750	750
800	800
850	850
900	900
950	950
1000	1000
1060	1060
1120	1120
1180	1180
1250	1250
1320	1320
1400	1400
1500	1500
1600	1600
1700	1700
1800	1800
1900	1900
2000	2000
2240	2240

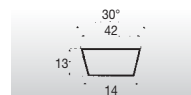

SECTION 42x13 W40	
Code	Nominal pitch length (mm)
W 40P	1060
W 40P	1100
W 40P	1120
W 40P	1180
W 40P	1250
W 40P	1400
W 40P	1600
W 40P	1660
W 40P	1820
W 40P	2000
W 40P	2240
W 40P	2500

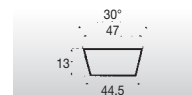

SECTION 47x13	
Code	Pitch length LI (mm)
900	900
950	950
1000	1000
1060	1060
1120	1120
1180	1180
1250	1250
1320	1320
1400	1400
1500	1500
1600	1600
1700	1700
1800	1800
1900	1900
2000	2000
2240	2240

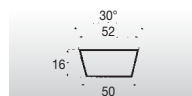

SECTION 52x16 W50	
Code	Pitch length (mm)
W 50P	1250
W 50P	1400
W 50P	1600
W 50P	1800
W 50P	2000
W 50P	2240
W 50P	2500
W 50P	2800
W 50P	3150

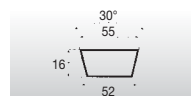

SECTION 55x16	
Code	Pitch length (mm)
1180	1180
1250	1250
1400	1400
1600	1600
1700	1700
1800	1800
2000	2000
2240	2240

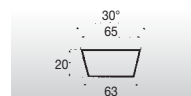

SECTION 65x20 W63	
Code	Pitch length (mm)
W 63P	1600
W 63P	1800
W 63P	2000
W 63P	2240
W 63P	2500
W 63P	2800
W 63P	3150
W 63P	3550
W 63P	4000

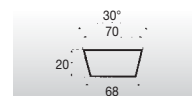

SECTION 70X20	
Code	Pitch length (mm)
1320	1320
1400	1400
1445	1445
1500	1500
1600	1600
1700	1700
1800	1800
1900	1900
2000	2000
2120	2120
2240	2240
2360	2360
2500	2500
2800	2800



PV
Rubber ribbed belts

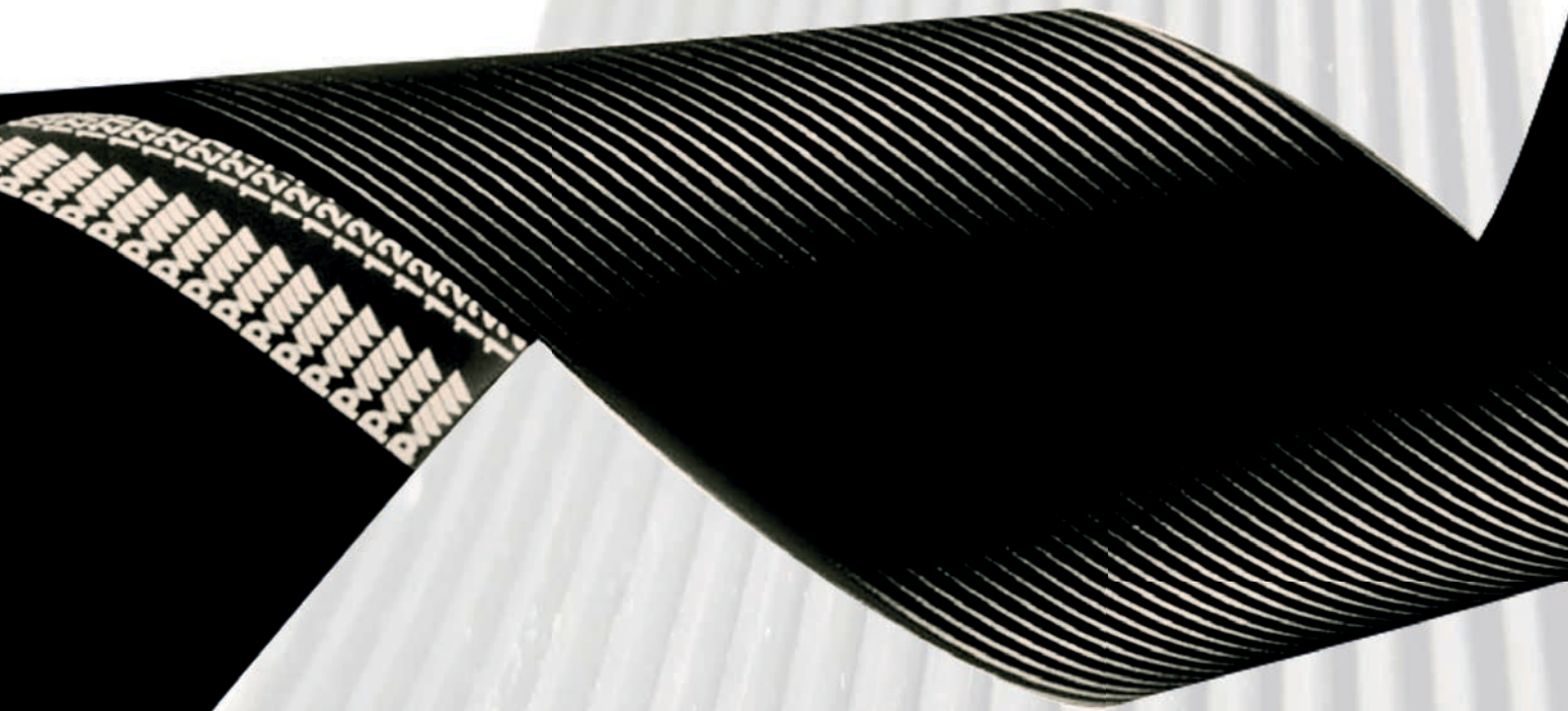

PV Rubber ribbed belts



PV V-RIBBED BELTS are made of polybutadiene compound. High performance V ribbed belts are produced in **H, J, K, L** and **M** profiles.

PV belts design:

- eliminates belt matching;
- permits drive design to meet exact power or space requirements;
- distributes the drive load across the entire belt width;
- permits cooler running and high drive efficiency;
- excels on small pulleys at high speeds.

PV-Ribbed belts are also available in elastic version (TEM) and they are suitable in the transmission where fixed centre distance is required. The TEM belt is developed according to the Customer requirements.

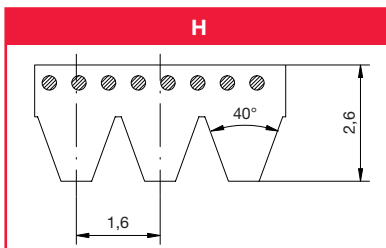
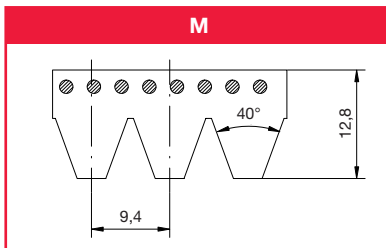
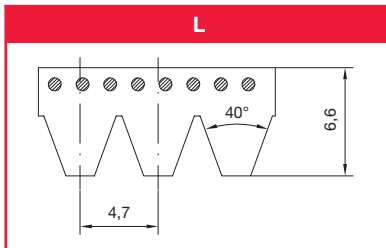
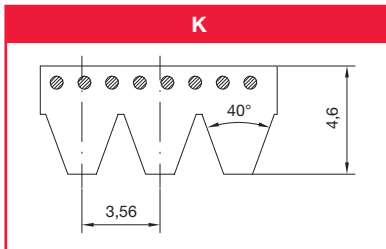
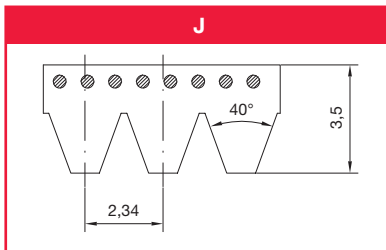

J		J		K		L		M	
Effective length (mm)	(inches)	Effective length (mm)	(inches)	Effective length (mm)	(inches)	Effective length (mm)	(inches)	Effective length (mm)	(inches)
350	13.8	1236	48.7	588	23.1	953	37.5	2286	90.0
381	15.0	1244	49.0	630	24.8	991	39.0	2388	94.0
406	16.0	1262	49.7	650	25.6	1074	42.3	2515	99.0
432	17.0	1270	50.0	675	26.6	1080	42.5	2693	106.0
457	18.0	1280	50.4	700	27.6	1100	43.3	2832	111.5
483	19.0	1287	50.7	730	28.7	1194	47.0	2921	115.0
495	19.5	1295	51.0	755	29.7	1270	50.0	3010	118.5
508	20.0	1301	51.0	775	30.5	1321	52.0	3124	123.0
533	21.0	1302	51.3	800	31.5	1333	52.5	3327	131.0
559	22.0	1315	51.8	830	32.7	1371	54.0	3531	139.0
584	23.0	1318	51.9	845	33.3	1397	55.0	3734	147.0
610	24.0	1321	52.0	870	34.3	1422	56.0	4089	161.0
635	25.0	1326	52.2	875	34.4	1435	56.5	4191	165.0
650	25.6	1365	53.7	885	34.8	1473	58.0	4470	176.0
660	26.0	1371	54.0	920	36.2	1511	59.5	4648	183.0
685	27.0	1397	55.0	925	36.4	1562	61.5	5029	198.0
711	28.0	1428	56.2	950	37.4	1613	63.5	5410	213.0
723	28.5	1473	58.0	970	38.2	1664	65.5	6121	241.0
737	29.0	1524	60.0	1000	39.4	1715	67.5	6883	271.0
762	30.0	1549	61.0	1015	40.0	1764	69.5	7646	301.0
769	30.3	1600	63.0	1035	40.8	1803	71.0	8408	331.0
790	31.1	1651	65.0	1060	41.7	1841	72.5	9169	361.0
813	32.0	1752	69.0	1080	42.5	1943	76.5	9931	391.0
864	34.0	1854	73.0	1145	45.1	1956	77.0	10693	421.0
895	35.2	1895	74.6	1165	45.9	1981	78.0	12217	481.0
914	36.0	1910	75.2	1200	47.2	2020	79.5	13741	541.0
944	37.2	1930	76.0	1230	48.4	2070	81.5	15266	601.0
955	37.6	1956	77.0	1300	51.2	2096	82.5	16764	660.0
965	38.0	2083	82.0	1335	52.6	2134	84.0		
990	39.0	2135	84.1	1385	54.5	2197	86.5		
1016	40.0	2210	87.0	1420	55.9	2235	88.5		
1036	40.8	2337	92.0	1460	57.5	2324	91.5		
1040	40.9	2489	98.0	1490	58.7	2362	93.0		
1051	41.4			1520	59.8	2476	97.5		
1065	41.9			1555	61.2	2515	99.0		
1080	42.5			1610	63.4	2705	106.5		
1089	42.9			1655	65.2	2743	108.0		
1092	43.0			1700	66.9	2845	112.0		
1100	43.3			1725	67.9	2895	114.0		
1108	43.6			1755	69.1	2921	115.0		
1116	43.9			1800	70.9	2997	118.0		
1136	44.7			1860	73.2	3086	121.5		
1143	45.0			1885	74.2	3124	123.0		
1150	45.3			1900	74.8	3289	129.5		
1160	45.7			1980	78.0	3327	131.0		
1168	46.0			2050	80.7	3492	137.0		
1170	46.1			2080	81.9	3683	145.0		
1184	46.6			2145	84.5	3696	145.5		
1190	46.9			2235	88.0	4051	159.5		
1194	47.0			2330	91.7	4191	165.0		
1200	47.2			2490	98.03	4470	176.0		
1203	47.4			2555	100.59	4622	182.0		
1210	47.6					5029	198.0		
1214	47.8					5385	212.0		
1222	48.1					6069	240.0		
1232	48.5								

H	
Effective length (mm)	(inches)
584	23.0
947	37.3
1011	39.8
1025	40.4
1030	40.6
1068	42.0
1140	44.9
1164	45.8
1184	46.6
1200	47.2
1210	47.6
1265	49.8
1809	71.2
1831	72.1
1856	73.1
1872	73.7
1891	74.4
1900	74.8
1915	75.4
1922	75.7
1930	76.0
1945	76.6
1980	78.0

MEGARIB
PU endless ribbed belts



MEGARIB

PU endless ribbed belts



MEGARIB belts are manufactured in polyurethane with polyester high tension cords, which combine the high flexibility of flat belts with the power transmission capability of v-belts.

These belts have the following features

- Dimensional stability
- High flexibility
- Small pulley diameters
- High speeds
- Excellent oil, water and ozone resistance

The main applications are

- Food processors
- Grass cutting equipment
- Electrical household appliances
- Washing machines
- Electrical tools
- Woodworking equipment
- Domestic power tools



On request, special elastic Megarib belts can be manufactured in polyurethane with a semi-elastic tension member. They can be fitted on fix centre drives, reducing noise and vibrations. The absence of a tensioning mechanism, offers additional cost savings.

Standard Megarib belts are available in a wide variety of rib pitches and length (see below).

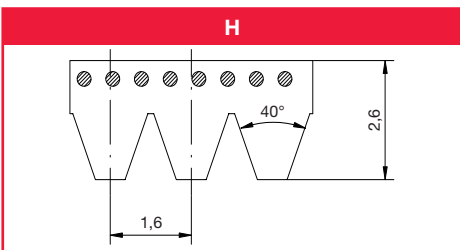
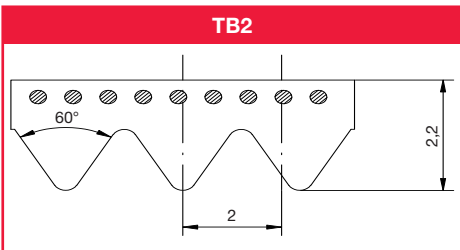
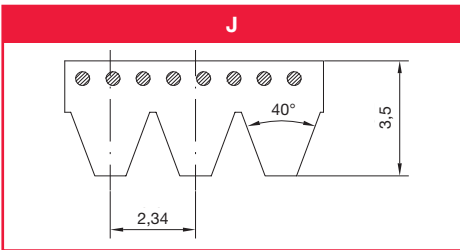

J	
Standard length (mm)	(inches)
220	8,7
271	10,7
275	10,8
278	10,9
283	11,1
288	11,3
304	12,0
317,5	12,5
330	13,0
345	13,6
356	14,0
381	15,0
392	15,4
406	16,0
431	17,0
444	17,5
457	18,0
483	19,0
508	20,0
558	22,0
584	23,0
610	24,0
630	24,8
660	26,0
681	26,8
711	28,0
762	30,0
864	34,0
914	36,0
953	37,5
1010	39,8
1086	42,8
1130	44,5
1163	45,8
1239	48,8
1268	49,9
1397	55,0

TB2	
Standard length (mm)	(inches)
156	6,1
170	6,7
200	7,9
220	8,7
231	9,1
237	9,3
248	9,8
266	10,5
295	11,6
310	12,2
327	12,9
330	13,0
345	13,6
360	14,2
380	15,0
390	15,4
400	15,7
430	16,9
480	18,9
510	20,1
526	20,7
535	21,1
575	22,6
598	23,5
630	24,8
660	26,0
675	26,6
725	28,5
770	30,3
1186	46,7

H	
Standard length (mm)	(inches)
223	8,8
254	10,0
261	10,3
269	10,6
295	11,6
330	13,0
340	13,4
345	13,6
375	14,8
389	15,3
400	15,7
410	16,1
588	23,1
609	24,0
650	25,6
768	30,2
935	36,8
1000	39,4
1086	42,8
1120	44,1
1163	45,8
1203	47,4
1240	48,8
1775	69,9
1976	77,8

MEGAFLAT
PU and Rubber endless flat belts



MEGAFLAT

PU and Rubber endless flat belts



MEGAFLAT belts are truly endless mandrel moulded, available in both polyurethane or chloroprene rubber, with either polyester, aramide or cotton reinforcements. Standard sleeves are available 330 mm wide.

These belts have the following features:

- High flexibility
- Small pulley diameters
- Dimensional accuracy
- High speed
- Energy efficient
- Low noise and vibration
- Low maintenance
- Good chemical and ozone resistance
- High friction surface

MEGAFLAT belts are particularly suitable for both power transmission and conveying.

RUBBER

	T 75	T 150	T 200
Tensile reinforcement	Polyester fabric	Polyester fabric	Polyester fabric
Installation tension x cm width (N) endless	150	300	400
Min. Pulley dia. mm	6	15	20
Thickness mm	0,5	0,9	1,1
Standard length mm	200/3850	200/3850	200/3850
Coating material	NEOPRENE	NEOPRENE	NEOPRENE
Antistatic	YES	YES	YES

POLYURETHANE

	P 0	P 102	P 108	P 110
Tensile reinforcement	No fabric	Polyester fabric / nylon	Polyester / cotton	Polyester fabric
Installation tension x cm width (N) endless	-	10	200	150
Min. Pulley dia. mm	8	25	5	12
Thickness mm	0,9	1,8	0,8	1
Standard length mm	240/1200	240/2500	240/3850	240/3850
Coating material	POLYURETHANE	POLYURETHANE	POLYURETHANE	POLYURETHANE
Antistatic	NO	POSSIBLE	POSSIBLE	POSSIBLE

	P 120	P 155	S 110
Tensile reinforcement	Polyester fabric	Aramid/polyester	Polyester fabric
Installation tension x cm width (N) endless	350	400	125
Min. Pulley dia. mm	20	25	12
Thickness mm	1,5	2	1,0
Standard length mm	240/3850	240/3850	240/3850
Coating material	POLYURETHANE	POLYURETHANE	SILICON
Antistatic	POSSIBLE	POSSIBLE	POSSIBLE

MEGAPOWER
PU endless timing belts

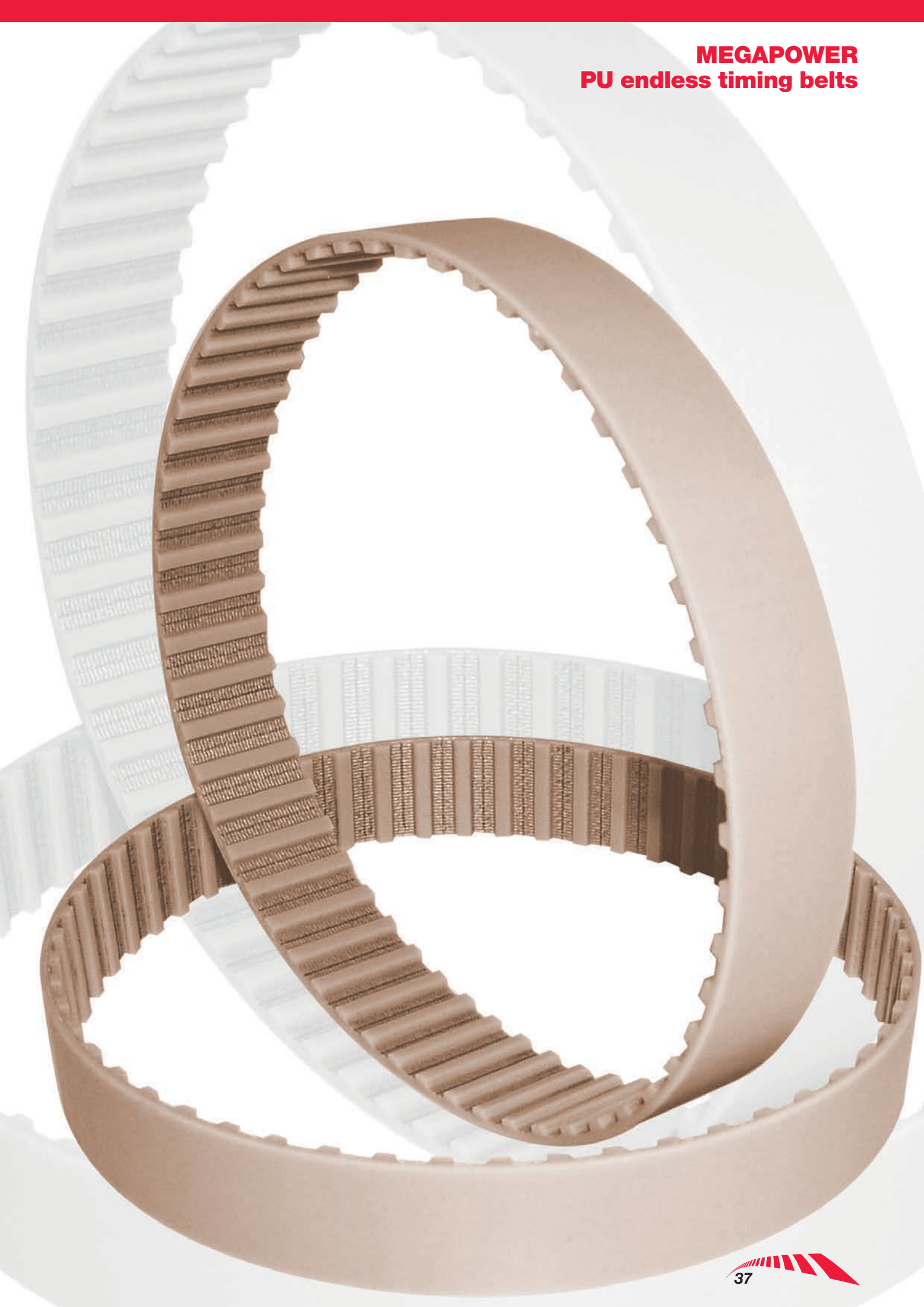

MEGAPOWER PU endless timing belts

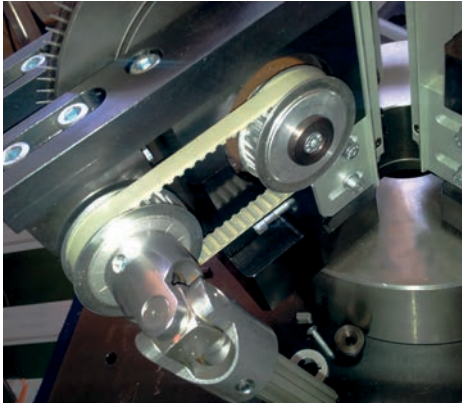

MEGAPOWER timing belts are manufactured by a unique thermoset moulding process.

The high-grade polyurethane gives excellent abrasion and shear resistance, combined with a variety of graded steel cords, ensuring high strength and tractive resistance. The result is a timing belt with excellent dimensional stability. Megapower moulded timing belts are manufactured to a tight tolerance range, which assures consistent length and thickness.

The combination of these factors results in Megapower, performing to the highest physical and chemical levels.

Special compounds and cords have to be tested and homologated on the application. Megadyne is not responsible for wrong functioning of special products.



MEGAPOWER PU belts are suitable for high power, precision motion and control even with high speed.

These belts have the following features:

MECHANICAL features

- Consistent dimensional stability
- Low pre-tension
- Low noise
- High abrasion resistance
- Low maintenance
- High flexibility
- Linear speeds up to 80 m/sec

CHEMICAL features

- Good resistance to
 - Aging,
 - Hydrolysis,
 - UVA rays,
 - Ozone
- Working temperature: -25 °C to +80 °C (up to +110 °C for short periods)
- High resistance to oils, fats and greases
- Good resistance to most acids and Alkalis

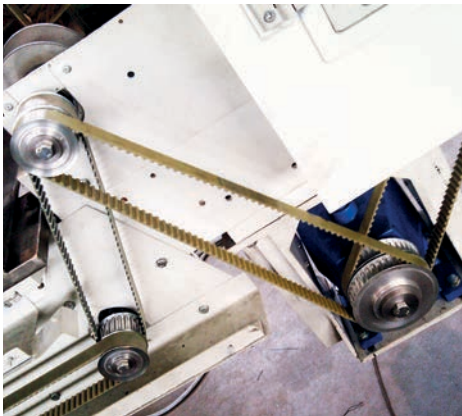

MEGAPOWER PU belts perform especially well on light synchronised and stepped drives, in office automation and domestic appliance applications.

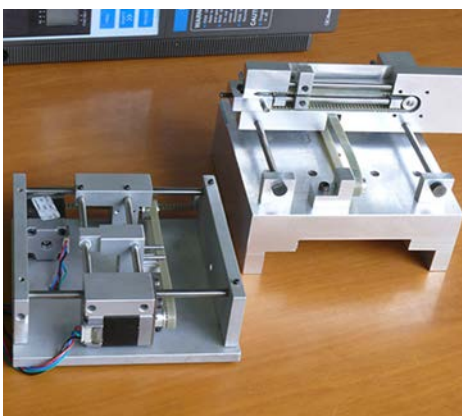

MEGAPOWER PU endless timing belts

T2	
Std. width (mm)	
4/6/8/10/12	

T2	
Code	Pitch length (mm)
180	180
200	200
288	288
P	2
H	1,1
H _i	0,5

T2.5	
Std. width (mm)	
4/6/8/10/12	

T2.5	
Code	Pitch length (mm)
120	120
145	145
160	160
177,5	177,5
180	180
182,5	182,5
200	200
210	210
230	230
245	245
265	265
277,5	277,5
285	285
290	290
305	305
317,5	317,5
330	330
342,5	342,5
380	380
420	420
480	480
500	500
540	540
600	600
620	620
650	650
680	680
700	700
780	780
880	880
915	915
950	950
1185	1185
P	2,5
H	1,3
H _i	0,7

T5	
Std. width (mm)	
6/8/10/12/16/20/25	

T5	
Code	Pitch length (mm)
120	120
150	150
165	165
180	180
185	185
200	200
210	210
215	215
220	220
225	225
245	245
250	250
255	255
260	260
270	270
275	275
280	280
295	295
300	300
305	305
330	330
340	340
350	350
355	355
365	365
375	375
390	390
395	395
400	400
410	410
420	420
425	425
440	440
445	445
450	450
455	455
460	460
475	475
480	480
500	500
510	510
515	515
515*	515*
525	525
545	545
550	550
560	560
560*	560*
575	575
590	590
600	600
610	610
620	620
630	630
640	640
650	650
660	660
675	675
690	690
700	700
720	720
725	725
750	750
765	765
780	780
800	800
815	815
830	830
840	840
850	850
860	860
885	885
900	900
920	920
940	940
990	990
1075	1075
1100	1100
1160	1160
1200	1200
1215	1215
1275	1275
1280	1280
1315	1315
1355	1355
1380	1380
1440	1440
1470	1470
1500	1500
1580	1580
1955	1955
P	5
H	2,2
H _i	1,2

T10	
Std. width (mm)	
10/12/16/20/25/32/50/75	

T10	
Code	Pitch length (mm)
260	260
320	320
340	340
370	370
390	390
400	400
410	410
440	440
450	450
480	480
500	500
530	530
550	550
560	560
600	600
600*	600*
610	610
630	630
630*	630*
650	650
660	660
680	680
690	690
700	700
720	720
720*	720*
730	730
750	750
780	780
800*	800*
810	810
840	840
850	850
880	880
890	890
900	900
900*	900*
910	910
920	920
920*	920*
950	950
960	960
970	970
980	980
1000	1000
1010	1010
1050	1050
1080	1080
1100	1100
1110	1110
1140	1140
1150	1150
1200	1200
1210	1210
1240	1240
1250	1250
1300	1300
1320	1320
1350	1350
1390	1390
1400	1400
1420	1420
1440	1440
1450	1450
1460	1460
1500	1500
1560	1560
1600	1600
1610	1610
1700	1700
1750	1750
1780	1780
1880	1880
1960	1960
2250	2250
P	10
H	4,5
H _i	2,5

T2.5 DD	
Std. width (mm)	
4/6/8/10/12	

T2.5 DD	
Code	Pitch length (mm)
457,5 DD	457,5
P	2,5
H	1,3
H _i	0,7

T5 DD	
Std. width (mm)	
6/8/10/12/16/20/25	

T5 DD	
Code	Pitch length (mm)
410 DD	410
460 DD	460
515 DD	515
525 DD	525
550 DD	550
590 DD	590
620 DD	620
685 DD	685
700 DD	700
750 DD	750
815 DD	815
840 DD	840
860 DD	860
940 DD	940
1100 DD	1100
P	5
H	2,2
H _i	1,2

T10 DD	
Std. width (mm)	
10/12/16/20/25/32/50/75	

T10 DD	
Code	Pitch length (mm)
260 DD	260
530 DD	530
630 DD	630
660 DD	660
700 DD	700
720 DD	720
800 DD	800
840 DD	840
900 DD	900
920 DD	920
980 DD	980
1010 DD	1010
1100 DD	1100
1150 DD	1150
1210 DD	1210
1240 DD	1240
1250 DD	1250
1320 DD	1320
1350 DD	1350
1420 DD	1420
1500 DD	1500
1610 DD	1610
1880 DD	1880
P	10
H	4,5
H _i	2,5

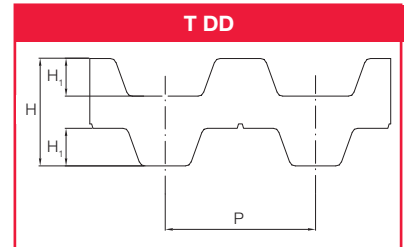
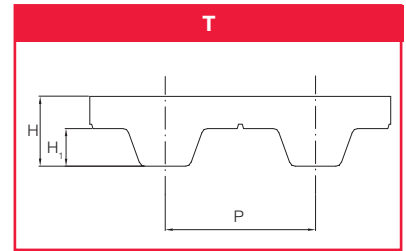

* Available without nose

MEGAPOWER

PU endless timing belts

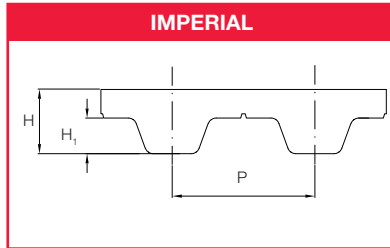
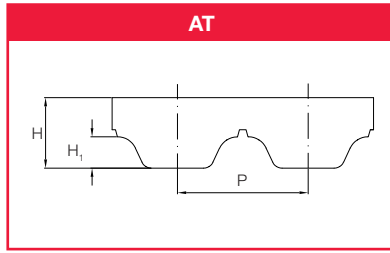

AT5	
Std. width (mm)	
6/8/10/12/16/20/25	

AT5	
Code	Pitch length (mm)
225	225
255	255
275	275
280	280
300	300
330	330
340	340
375	375
390	390
420	420
450	450
455	455
480	480
500	500
525	525
545	545
600	600
610	610
620	620
630	630
660	660
670	670
710	710
720	720
750	750
780	780
825	825
860	860
975	975
1050	1050
1125	1125
1500	1500
2000	2000
P	5
H	2,7
H₁	1,2

AT10	
Std. width (mm)	
10/12/16/20/25/32/50/75	

AT10	
Code	Pitch length (mm)
370	370
500	500
560	560
580	580
600	600
610	610
630	630
660	660
700	700
730	730
780	780
800	800
810	810
840	840
880	880
890	890
920	920
960	960
980	980
1000	1000
1010	1010
1050	1050
1080	1080
1100	1100
1150	1150
1190	1190
1200	1200
1210	1210
1220	1220
1230	1230
1240	1240
1250	1250
1280	1280
1300	1300
1320	1320
1350	1350
1360	1360
1400	1400
1420	1420
1480	1480
1500	1500
1600	1600
1630	1630
1700	1700
1720	1720
1800	1800
1860	1860
1940	1940
P	10
H	4,5
H₁	2,5

MXL	
Std. width (mm)	
3,2/4,8/6,4	

MXL	
Code	Pitch length (mm)
44	111,7
45,6	115,8
48	121,9
57,6	146,3
60	152,4
60,8	154,4
63,2	160,5
64	162,5
65,6	166,6
70,4	178,8
72,8	184,9
73,6	186,9
76,8	195,1
80,8	205,2
81,6	207,2
82,4	209,2
84	213,3
88	223,5
91,2	231,6
94,4	239,7
96	243,8
104	264,1
105,6	268,2
108	274,3
112	284,4
116	294,6
120	304,8
124	314,9
140	355,6
152	386,5
160	406,8
176,8	449,1
204,8	520,1
224	568,9
228	579,1
246,4	625,8
265,6	674,6
281,6	715,2
288	731,5
316	802,6
324	822,9
329,6	837,1
345,6	877,8
363,2	922,5
388	985,5
P	2,032
H	1,2
H₁	0,51

XL	
Std. width (mm)	
6,4/7,9/9,4	

XL	
Code	Pitch length (mm)
60	152,4
70	177,8
76	193,0
80	203,2
90	228,6
100	254,0
110	279,4
120	304,8
130	330,2
134	340,3
140	355,6
150	381,0
160	406,4
170	431,8
180	457,2
190	482,6
194	492,7
200	508,0
210	533,4
220	558,8
230	584,2
240	609,6
250	635,0
260	660,4
270	685,8
288	731,5
290	736,6
300	762,0
356	904,2
414	1051,5
450	1143,0
566	1437,6
P	5,08
H	2,3
H₁	1,7

L	
Std. width (mm)	
12,7/19,1/25,4	

L	
Code	Pitch length (mm)
86	218,6
124	314,3
150	381,0
173	438,1
187	476,2
202	514,4
210	533,4
225	571,5
240	609,6
255	647,7
270	685,8
285	723,9
300	762,0
322	817,9
345	876,3
367	933,4
390	990,6
420	1066,8
450	1143,0
480	1219,2
510	1295,4
540	1371,6
570	1447,8
600	1524,0
P	9,525
H	3,6
H₁	1,9

H	
Std. width (mm)	
19,1/25,4/38,1/50,8/76,2	

H	
Code	Pitch length (mm)
230	584,2
240	609,6
270	685,8
300	762,0
330	838,2
360	914,4
390	990,6
420	1066,8
450	1143,0
480	1219,2
510	1295,4
P	12,7
H	4,3
H₁	2,29

MEGALINEAR
PU open-end timing belts

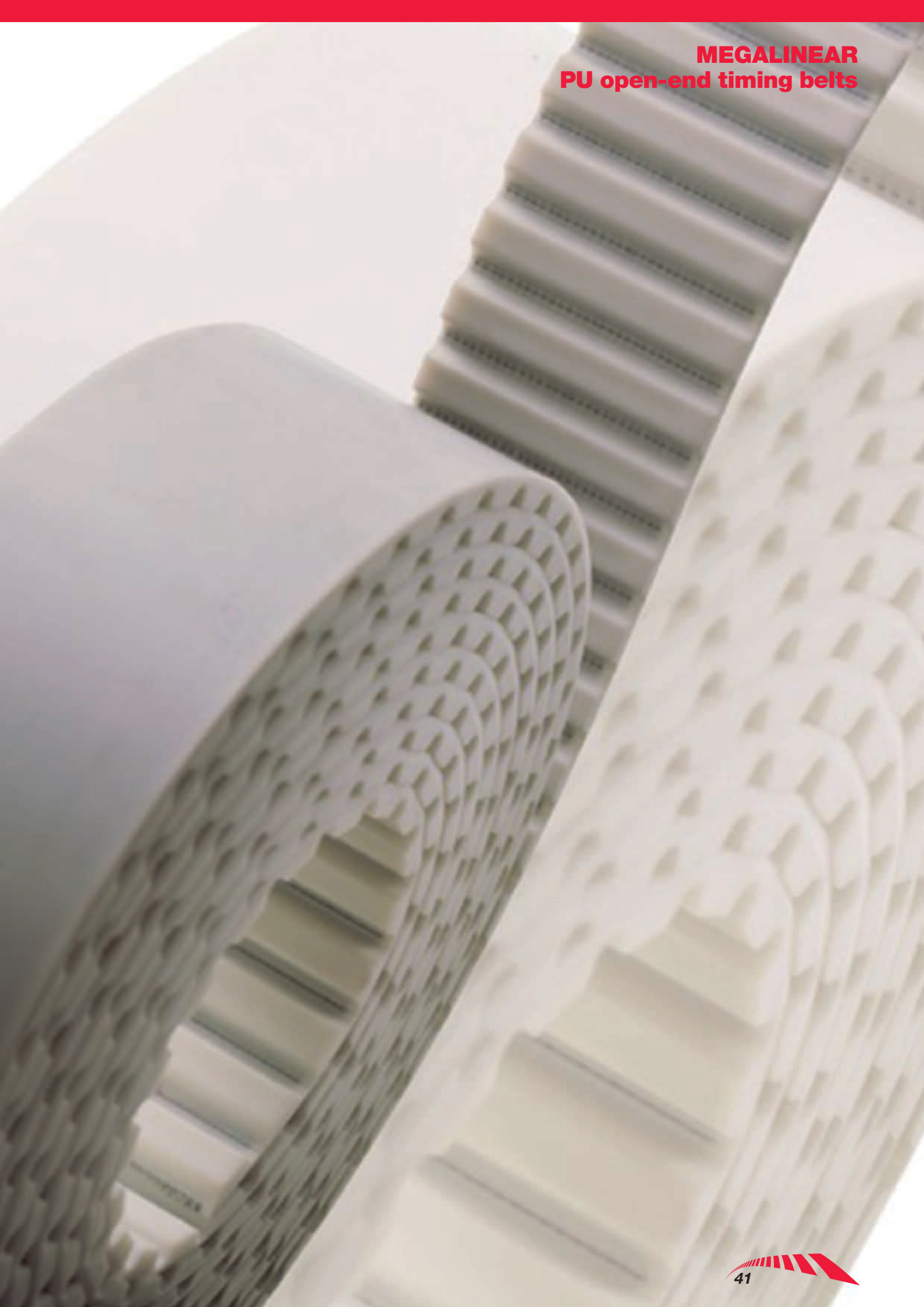

MEGALINEAR

PU open-end timing belts



MEGALINEAR open length timing belts are manufactured in thermoplastic polyurethane, that gives superior wear and abrasion resistance.

Various grades of steel cords offer good running characteristics, even with high tractive loads.

Manufactured to tight tolerances, Megalinear delivers reliability and excellent dimensional stability. The addition of a Nylon coating on the tooth and/or the back of the belt during production, enhances the running properties for specific applications. An extra thickness of polyurethane is also possible on the back of the belt, offering extra protection against aggressive or heavy products.

MEGALINEAR offers the following features:

MECHANICAL features

- Consistent dimensional stability
- Low pre-tension
- Low noise
- High abrasion resistance
- Low maintenance
- High flexibility
- Linear speeds up to 80 m/sec
- High precision linear positioning

CHEMICAL features

- Good resistance to Aging,
- Hydrolisis,
- UVA rays,
- Ozone
- Working temperature: -25 °C to +80 °C (up to +110 °C for short periods)
- High resistance to oils, fats and greases
- Good resistance to most acids and Alkalis
- Compatible for fabrication with other thermoplastic materials

MEGALINEAR can be supplied as open length rolls, or as endless jointed belts.

OPEN LENGTH Belts

These are manufactured as continuous lengths, with the reinforcement in a parallel configuration. Standard roll lengths are 50 or 100 metres.

Other lengths available on request.

MEGALINEAR belts as an open length are normally used in linear motion drives.

ENDLESS JOINTED belts

By jointing using the thermoplastic properties of the open length belt, endless belts can be produced to any length by welding. The finished joint is resistant to fatigue from flexing and tension, due to the unique symmetrical Vee shaped pattern of the joint.

Endless jointed belts are suitable for conveying applications, particularly when indexing and/or positive drive is required. Supplementary application of flights, profiles and coatings is possible, to suit specific applications.

MEGALINEAR is also available with alternative reinforcement cords such as, Kevlar (K), High Flex (HF), High Performance (HP) and High Performance Flex (HPF).



MEGALINEAR PU open-end timing belts

MXL		XL		L	
Std. width (inches)		Std. width (inches)		Std. width (inches)	
	0,17		0,25		0,37
	0,37		0,37		0,50
	0,50		0,50		0,75
			0,75		1,00
			1,00		1,50
			1,50		2,00
			2,00		4,00
P	2,032	P	5,08	P	9,525
H	1,14	H	2,3	H	3,6
H _i	0,66	H _i	1,27	H _i	1,90

H		H*		XH	
Std. width (inches)		Std. width (inches)		Std. width (inches)	
	0,50		8,00		1,00
	0,75		10,00		1,50
	1,00		12,00		2,00
	1,50		16,00		3,00
	2,00		20,00		4,00
	3,00				6,00
	4,00				
	6,00				
P	12,7	P	12,7	P	22,225
H	4,3	H	4,3	H	11,2
H _i	2,29	H _i	2,29	H _i	6,35

T2.5		T5		T5*		T10	
Std. width (mm)		Std. width (mm)		Std. width (mm)		Std. width (mm)	
	10		6		250		12
	16		10		500		16
	20		16				25
			25				32
			32				50
			50				75
			75				100
			100				150
P	2,5	P	5	P	5	P	10
H	1,3	H	2,2	H	2,3	H	4,5
H _i	0,7	H _i	1,2	H _i	1,2	H _i	2,5

T10*		T10 without gap		T20	
Std. width (mm)		Std. width (mm)		Std. width (mm)	
	200		16		25
	250		25		32
	300		32		50
	400		50		75
	450		75		100
	500				150
					200
P	10	P	10	P	20
H	4,5	H	4,5	H	8
H _i	2,5	H _i	2,5	H _i	5

AT3		AT5		AT10		AT10 without gap		AT20	
Std. width (mm)		Std. width (mm)		Std. width (mm)		Std. width (mm)		Std. width (mm)	
	10		6		16		25		25
	20		10		25		32		32
	25		16		32		50		50
	50		25		50		75		75
			32		75		100		100
			50		100				150
			75		150				200
			100						
P	3	P	5	P	10	P	10	P	20
H	1,9	H	2,7	H	4,5	H	4,5	H	8
H _i	1,1	H _i	1,2	H _i	2,5	H _i	2,5	H _i	5

RPP5		RPP8		RPP14	
Std. width (mm)		Std. width (mm)		Std. width (mm)	
	10		10		40
	15		15		55
	25		20		85
	30		30		115
	50		50		
	75		85		
			100		
P	5	P	8	P	14
H	3,8	H	5,4	H	10
H _i	2	H _i	3,2	H _i	6

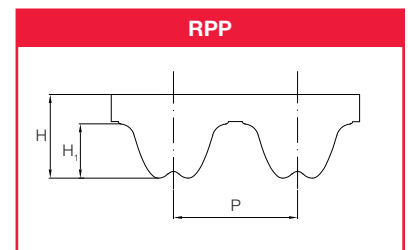
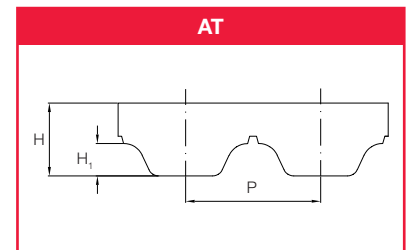
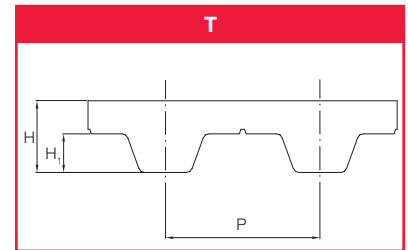
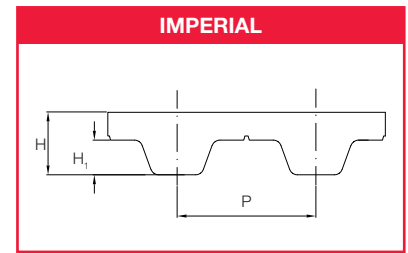

* Only with kevlar cords and reduced number of cords

MEGALINEAR

PU open-end timing belts

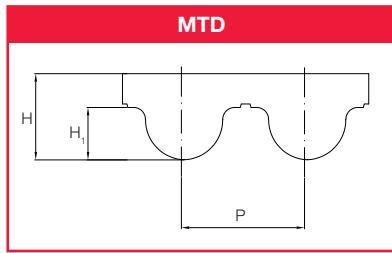

MTD 3M	
Std. width (mm)	
10	
20	
25	
50	
P	3
H	2,2
H ₁	1,13

MTD 5M	
Std. width (mm)	
10	
15	
25	
50	
P	5
H	3,6
H ₁	2,1

MTD 8M	
Std. width (mm)	
10	
15	
20	
30	
50	
85	
100	
P	8
H	5,6
H ₁	3,4

MTD 14M	
Std. width (mm)	
25	
40	
55	
85	
100	
P	14
H	10
H ₁	6,1

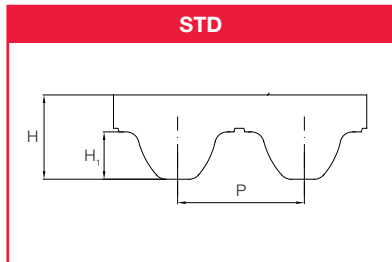

STD 5M	
Std. width (mm)	
10	
15	
25	
50	
P	5
H	3,4
H ₁	1,91

STD 8M	
Std. width (mm)	
10	
12	
15	
20	
30	
50	
85	
P	8
H	2,7
H ₁	1,2

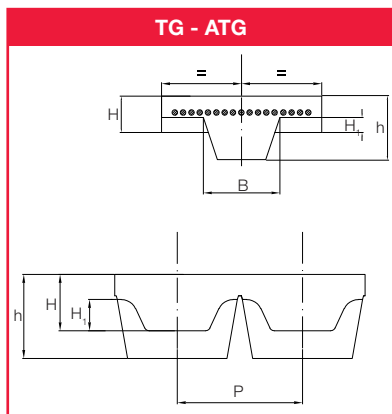

TG5 K6	
Std. width (mm)	
25	
32	
50	
P	5
H	2,2
H ₁	1,2
B	6
h	4

TG10 K6	
Std. width (mm)	
50	
P	10
H	4,5
H ₁	2,5
B	6
h	3,3

TG10 K13	
Std. width (mm)	
25	
32	
50	
75	
100	
P	10
H	4,5
H ₁	2,5
B	13
h	6,5

TG20 K13	
Std. width (mm)	
50	
75	
100	
P	20
H	8
H ₁	5
B	13
h	5,5

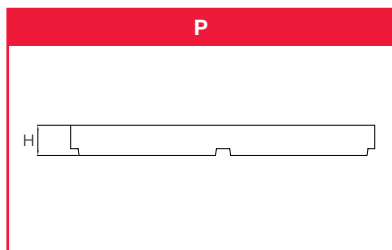

ATG5 K6	
Std. width (mm)	
25	
32	
50	
P	5
H	2,7
H ₁	1,2
B	6
h	4

ATG10 K13	
Std. width (mm)	
25	
32	
50	
75	
100	
150	
P	10
H	4,5
H ₁	2,5
B	13
h	7

ATG20 K13	
Std. width (mm)	
75	
150	
P	20
H	8
H ₁	5
B	13
h	6,4

HG K13	
Std. width (mm)	
1,50	
2,00	
3,00	
4,00	
P	12,7
H	4,3
H ₁	2,29
B	13
h	6,29

P1	
Std. width (mm)	
10	
20	
H	1

P2	
Std. width (mm)	
25	
50	
75	
100	
H	2

P3	
Std. width (mm)	
30	
60	
100	
120	
H	3

P4	
Std. width (mm)	
25	
50	
100	
H	4

MEGAFLEX
PU truly endless timing belts

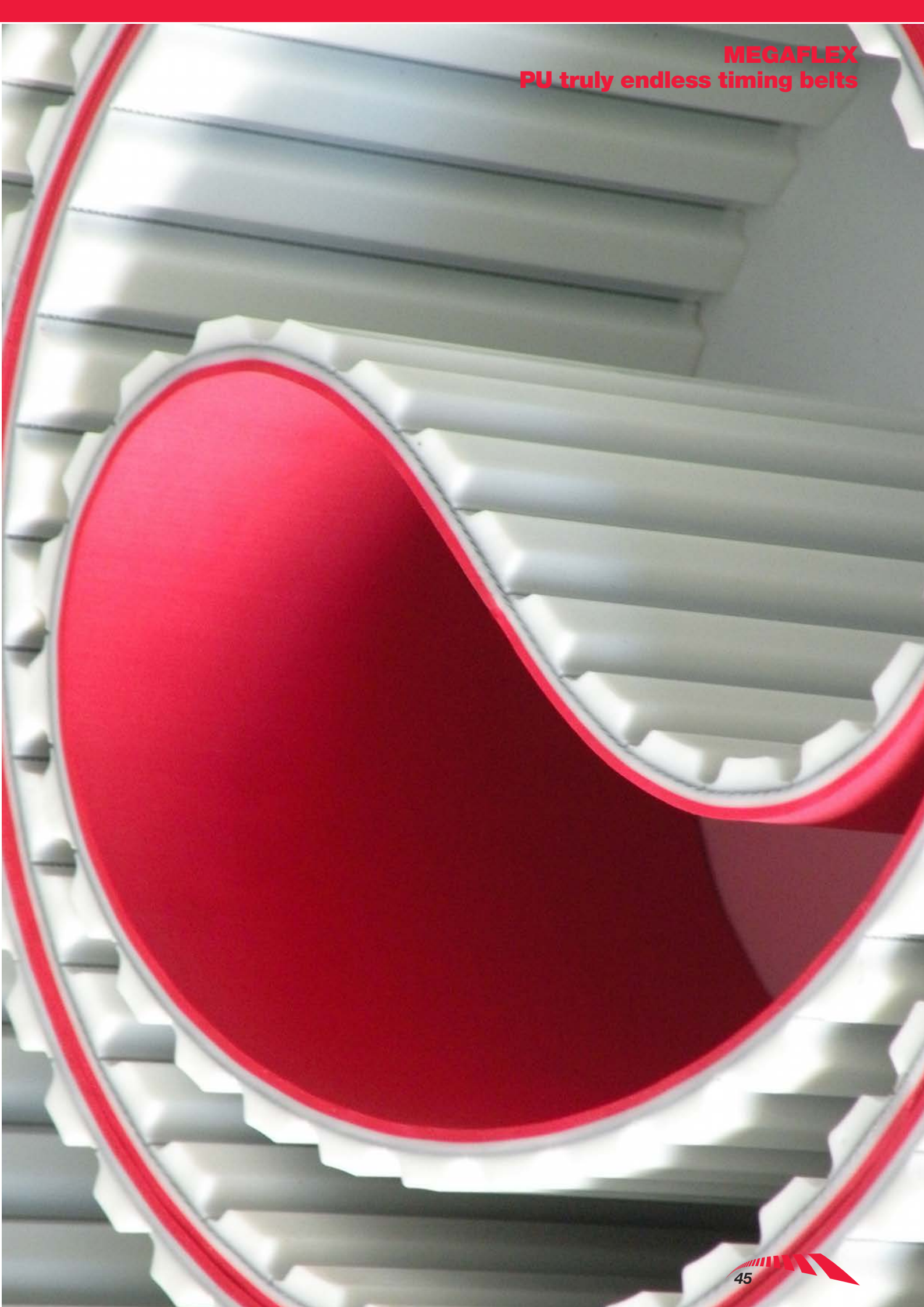

MEGAFLEX PU truly endless timing belts

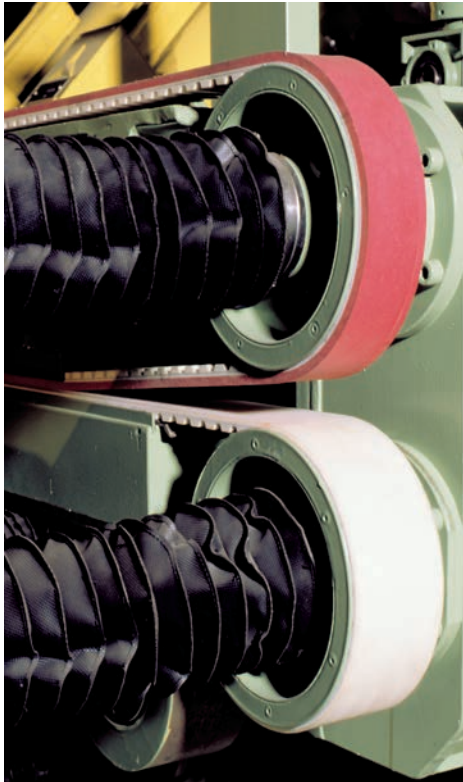

MEGAFLEX TIMING BELTS are manufactured in thermoplastic polyurethane, with continuous spiral steel cords.

This type of belt, developed by our Research & Development, offers good running characteristics and high traction loads.

They are especially suited for power transmission and conveying with high loads and high speeds (up to 10.000 RPM).

The addition of a nylon coating on the teeth during production enhances the running properties for specific applications and reduces the noise frictional coefficient.

An extra thickness of special coating is also possible on the back of the belt offering extra protection against aggressive or heavy products.

Megaflex belts are truly endless, enabling them to deliver exceptional performance.

MEGADYNE MEGAFLEX TIMING BELTS ARE AVAILABLE FROM 1.500 UP TO 22.700 mm LENGTH.

MEGAFLEX Special constructions

- High flex cords
- (NFT) nylon fabric on the teeth (available from 1.900 mm length)
- Custom milling, grinding and drilling to specification
- Additional continuous coatings on the back of the belt in:

- PU 85° ShA
- Tenax 50° ShA
- Linatex 40° ShA
- Yellow PUR 60° ShA
- Grey PUR 60° ShA
- Neoprene rubber 70° ShA

Other hardnesses available on request.

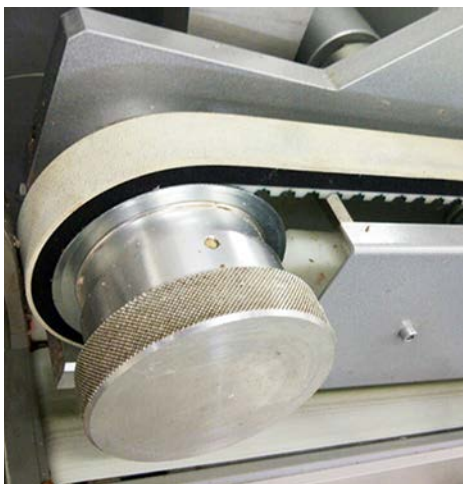

MEGAFLEX PU truly endless timing belts

XL/XLDD	
Std. width (mm)	
12,7	
19,05	
25,4	
38,1	
50,8	
76,2	
101,6	
152,4	
P	5,08
H	2,3
H _i	1,27
H _t	3,05

L/LDD	
Std. width (mm)	
12,7	
19,05	
25,4	
38,1	
50,8	
76,2	
101,6	
152,4	
P	9,525
H	3,6
H _i	1,9
H _t	4,58

H/HDD	
Std. width (mm)	
12,7	
19,05	
25,4	
38,1	
50,8	
76,2	
101,6	
152,4	
P	12,7
H	4,3
H _i	2,29
H _t	5,95

XH/XHDD	
Std. width (mm)	
25,4	
38,1	
50,8	
76,2	
101,6	
152,4	
P	22,225
H	11,2
H _i	6,35
H _t	15,49

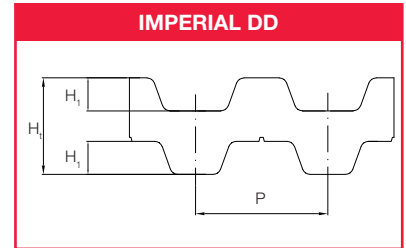
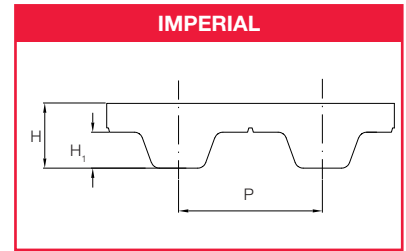

T5/T5DD	
Std. width (mm)	
10	
16	
25	
32	
50	
75	
100	
150	
P	5
H	2,2
H _i	1,2
H _t	3,4

T10/T10DD	
Std. width (mm)	
12	
16	
25	
32	
50	
75	
100	
150	
P	10
H	4,5
H _i	2,5
H _t	7

T20/T20DD	
Std. width (mm)	
25	
32	
50	
75	
100	
150	
P	20
H	8
H _i	5
H _t	13

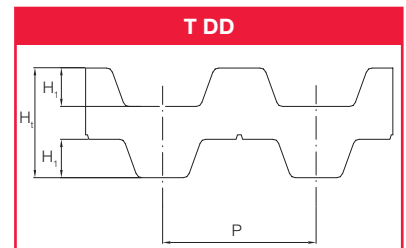
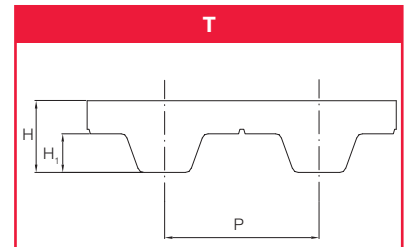

AT5/AT5DD	
Std. width (mm)	
10	
16	
25	
32	
50	
75	
100	
150	
P	5
H	2,7
H _i	1,2
H _t	3,9

AT10/AT10DD	
Std. width (mm)	
12	
16	
25	
32	
50	
75	
100	
150	
P	10
H	4,5
H _i	2,5
H _t	7

AT20/AT20DD	
Std. width (mm)	
25	
32	
50	
75	
100	
150	
P	20
H	8
H _i	5
H _t	13

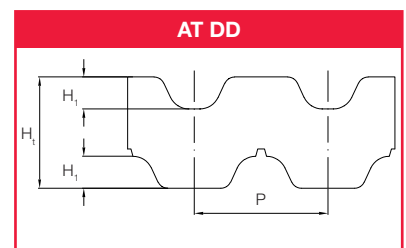
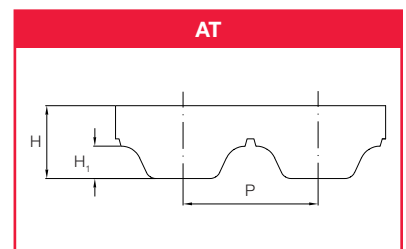

MEGAFLEX

PU truly endless timing belts

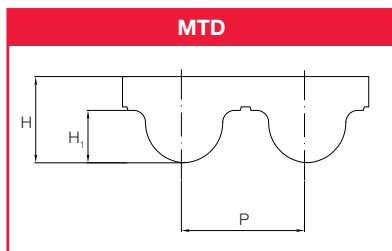

MTD 8M	
Std. width (mm)	
	15
	20
	30
	50
	85
	100
	150
	150
P	8
H	5,6
H ₁	3,4

ATG10 K13	
Std. width (mm)	
	25
	32
	50
	75
	100
	150
	150
P	10
H	4,5
H ₁	2,5
B	13
h	9

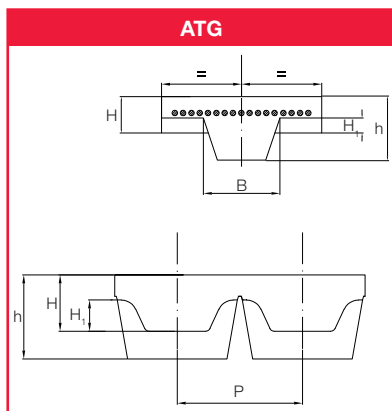

RPP5/RPP5DD	
Std. width (mm)	
	10
	15
	25
	30
	50
	85
	100
	150
	150
P	5
H	3,8
H ₁	2
H _t	5,2

RPP8/RPP8DD	
Std. width (mm)	
	15
	20
	30
	50
	85
	100
	150
	150
P	8
H	5,4
H ₁	3,2
H _t	7,8

RPP14/RPP14DD	
Std. width (mm)	
	25
	40
	55
	85
	115
	150
	150
P	14
H	10
H ₁	6
H _t	14,5

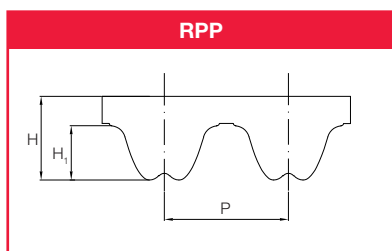
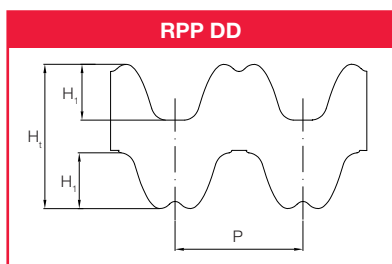

P2	
Std. width (mm)	
	25
	50
	75
	100
	150
	150
P	2

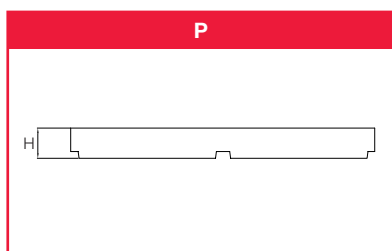

SPECIAL PRODUCTS
Special Covers, Cleats, Special Reworking



SPECIAL PRODUCTS

Special Covers

Megadyne offers a variety of coverings in Polyurethane, elastomer, foam, PVC and other unique solutions, designed for your specific requirements. Choose the covering that interests you and request information from our OEM team, we will suggest the right solution.

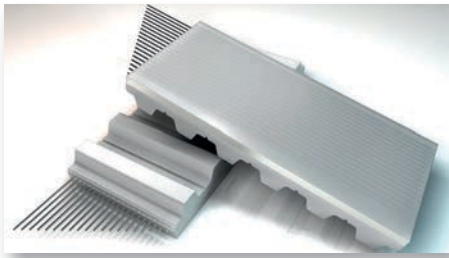

AVAFC 60 - Coating used for conveying abrasive materials, with high friction coefficient, very good resistance to oil and to abrasion.

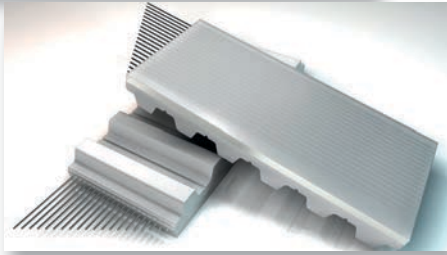

AVAFC 70 - Coating used for conveying abrasive materials, with high friction coefficient, very good resistance to oil and to abrasion.

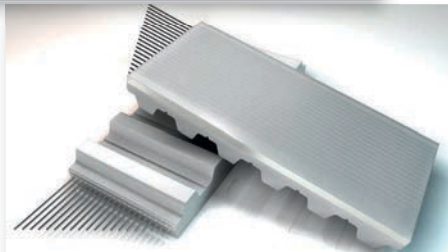

AVAFC 85 - Coating used for conveying abrasive materials, with high friction coefficient, very good resistance to oil and to abrasion.

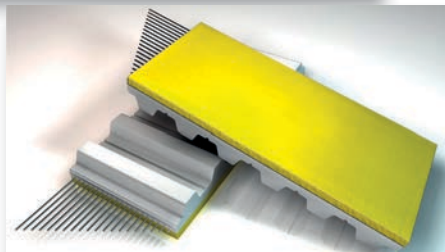

FOAMED POLYURETHANE - Coating used for vacuum conveying systems, with good resistance to friction, good resistance to oil and to abrasion.

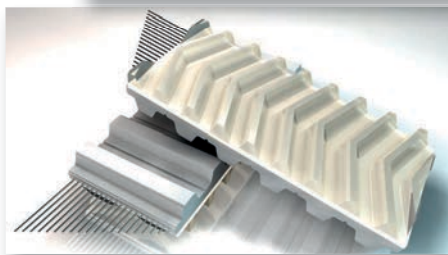

FISHBONE - Coating used for conveying system in the glass industry, with high friction coefficient and very good resistance to oil.



RIBBED - Coating used for the packaging industry, with high friction coefficient and very good resistance to oil.

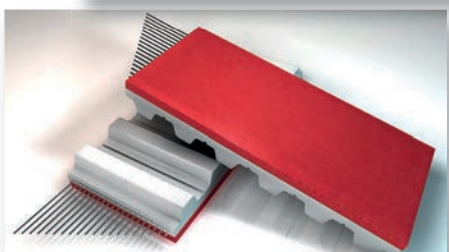

LINATEX - Coating used for conveying abrasive materials, with high friction coefficient, good wear resistance to wear and water.

SPECIAL PRODUCTS Special Covers

TENAX 40 - Coating used for conveying abrasive materials, with high friction coefficient, good resistance to wear and water.

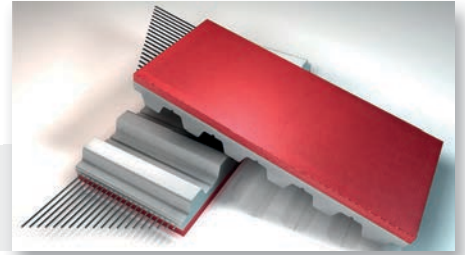

TENAX STANDARD - Coating used for conveying abrasive materials, using materials with high friction coefficient and good wear resistance.

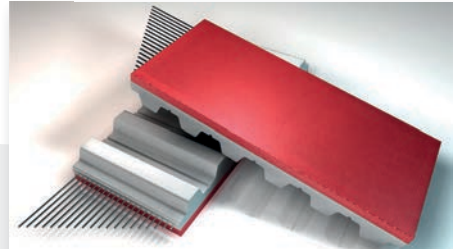

GUMMY CORREX AMBRA PARABLOND - Coating used for conveyor system, using materials with good friction resistance, low resistance to oil and wear but very good resistance to water.

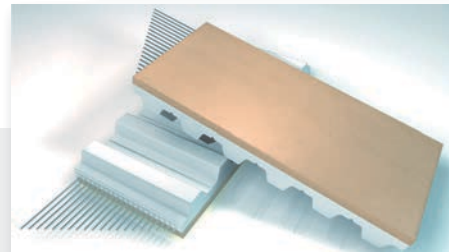

HONEY COMB - Coating used for packaging industry, natural rubber with good resilience and high wear resistance. Very good water resistance.

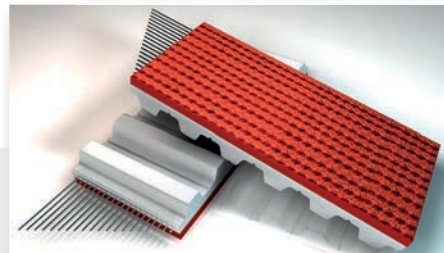

HYPALON - Coating used for conveyors system, using materials with good friction resistance and good resistance to the water, oils and wear.

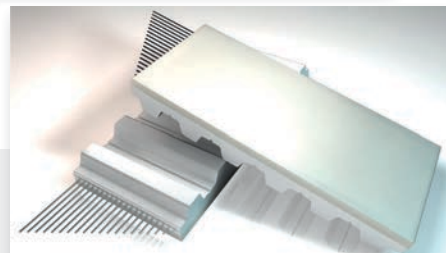

WHITE RUBBER FOR FOOD INDUSTRY - Coating used for conveying food, with good resistance to water, natural oils and natural greases. Easy to clean.

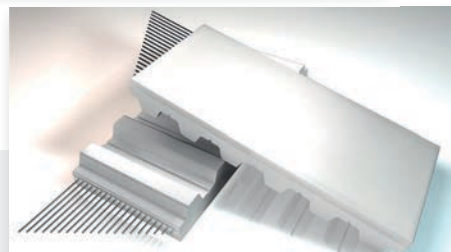

NEOPRENE - Coating used for conveying delicate and small materials, with good resistance to oil and abrasion. The material used is not flammable self extinguishing.

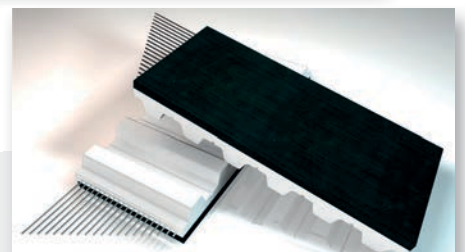

SPECIAL PRODUCTS

Special Covers

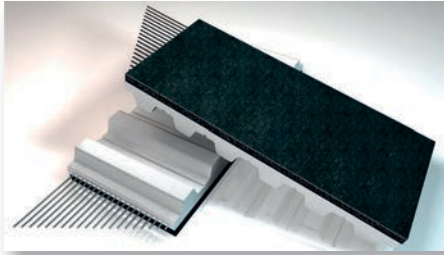

POROL MOUSSE - Coating used for conveying fragile items, using materials with high friction coefficient and intermediate resistance to oils and greases.

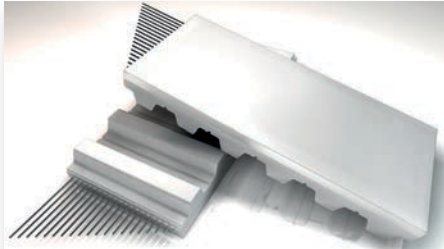

NBR - Coating used where an high abrasion resistance is needed, with low compression set and high elasticity.

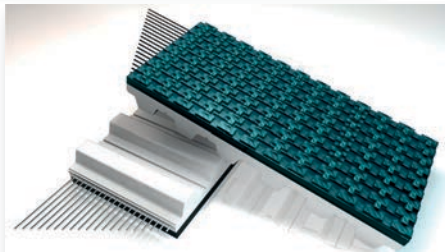

PVC SUPERGRIP - Coating used for conveying very different materials like wood and paper, using materials with good friction resistance and good resistance to water and oil.

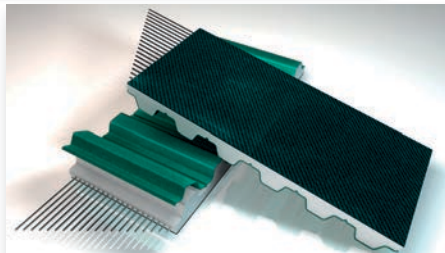

NFT NYLON FABRIC TEETH - Coating used for conveying system, with low friction coefficient and intermediate resistance to oils but good to water.

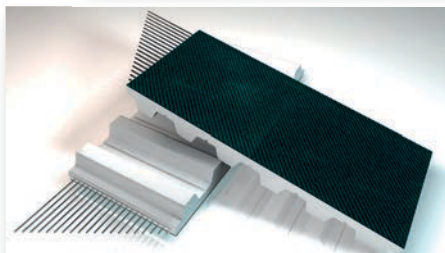

NFB NYLON FABRIC BACK - Coating used for conveying system, with low friction coefficient and intermediate resistance to oils but good to water.

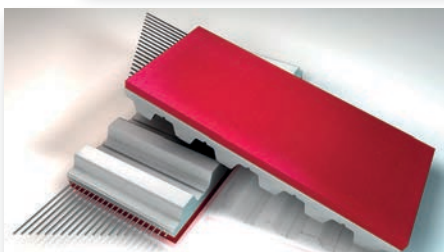

RED GRIP - Coating used for conveying very different materials, with high friction coefficient, good resistance to water and very good resistance to oils and abrasion.

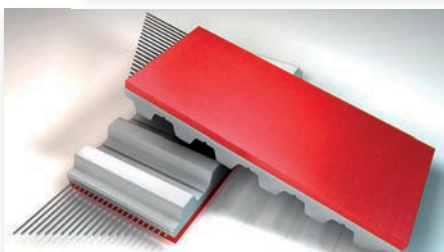

APL - Coating used for conveying very different materials, with high friction coefficient and good resistance to oils and wear.

SPECIAL PRODUCTS Cleats

Megadyne timing belts can be customised by vulcanizing profiles vulcanized on their back. All the cleats are made using thermoplastic polyurethane. The cleats are attached using high frequency vibration welding. The production process for these profiles is very flexible; Megadyne can design any profile to meet the specific customer requirement.

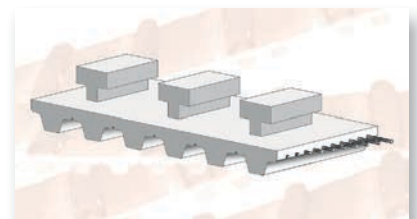
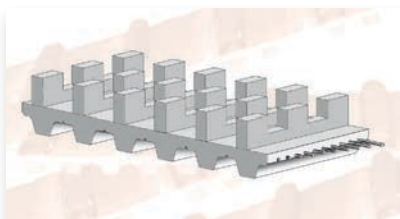
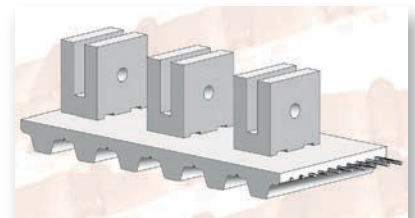
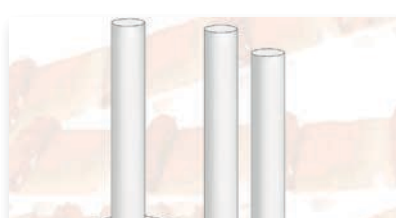
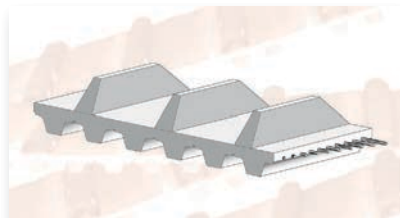
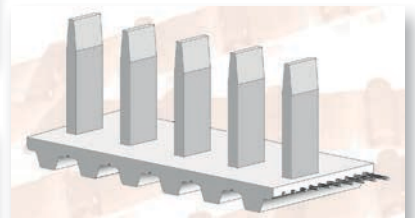
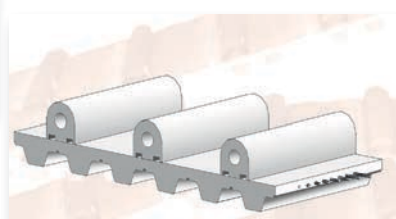
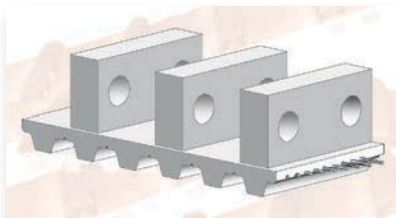
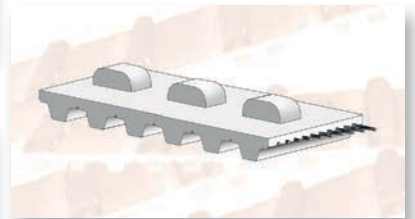
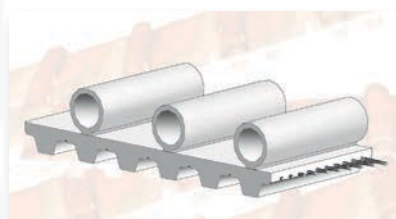
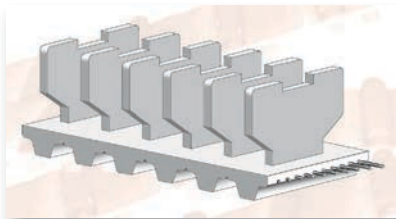
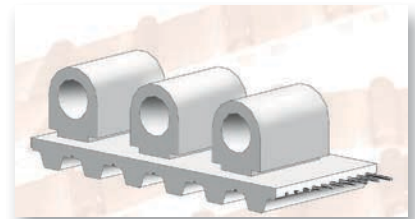
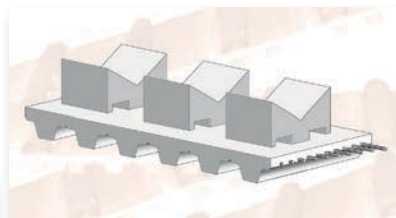
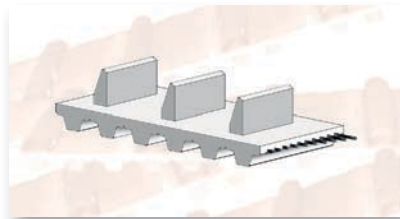
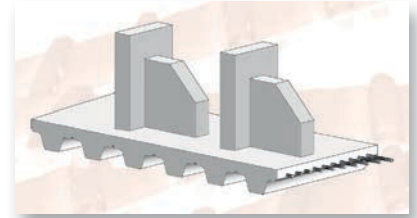
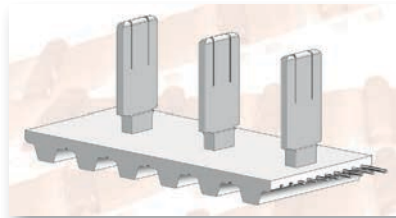
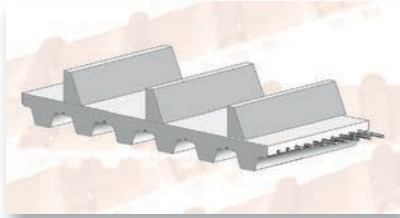

SPECIAL PRODUCTS

Special Reworking

Megadyne can make special extrusions on customer request to enhance specific belt properties and to better suit special applications.

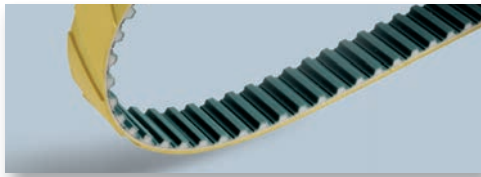

“GLASS INDUSTRY”



“FISH INDUSTRY”



“CARTON INDUSTRY”



“PAPER INDUSTRY”



“TOBACCO INDUSTRY”

PPJ SYSTEM

Technical features

- Reduced load capacity when compared to standard joined belts
- Created to allow the jointing of belts directly on the machine
- Allows a very fast belt replacement
- The back of the belts is virtually flat
- Born for conveying applications only, max suggested speed is 120 m/min
- Pin materials according to AISI302
- Rolls with NFT, NFB, AVAFC, APL, Fishbone, Ribbed and Supergrip can be PPJed
- Minimum splice length of 700 mm

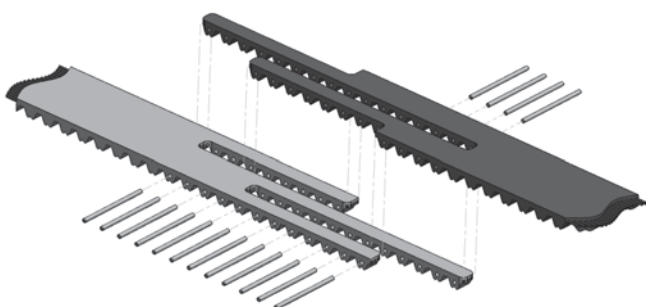

STOP to maintenance shutdowns

SECTION	Width* (mm)	Length* (mm)
T10 25	25	180
T10 32	32	220
T10 50	50	220
T10 75	75	240
T10 100	100	320
T20 32	32	260
T20 50	50	320
T20 75	75	340
AT10 25	25	180
AT10 32	32	220
AT10 50	50	220
AT10 75	75	240
AT10 100	100	320
AT20 32	32	260
AT20 50	50	320
AT20 75	75	340
MTD8 20	20	128
MTD8 30	30	176
MTD8 50	50	176
MTD8 85	85	192
MTD8 100	100	256
RPP8 20	20	128
RPP8 30	30	176
RPP8 50	50	176
RPP8 85	85	192
RPP8 100	100	256
TG10 50	50	220
ATG10 50	50	220

*For different widths and/or lengths please contact us

METAL
Pulleys, Timing Bars, Taper Bushes and Clamping Plates

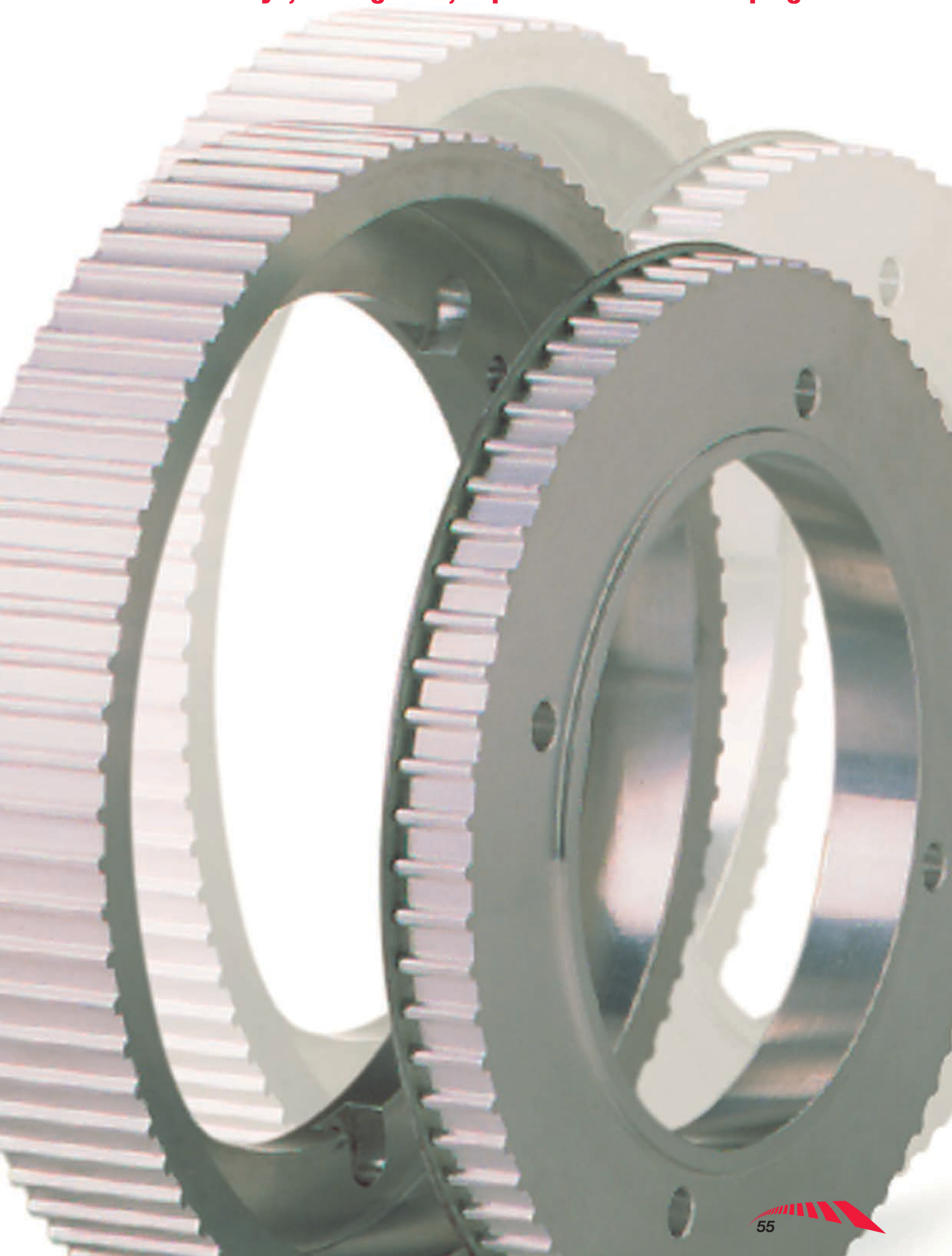

METAL Pulleys



Megadyne stocks and supplies an extensive range of pulleys and accessories like timing bars, taper bushes, flanges and clamping plates to offer a complete drive transmission system.

Megadyne custom made metal products can be designed to meet all the customer requirements.

PULLEYS

Megadyne can supply a complete drive system. A large range of standard and custom made pulleys are available, for many kinds of industrial applications.

SECTION

T2,5 – T5 – T10 – T20 – AT5 – AT10 – AT20 – MXL – XL
L – H – XH – HTD3 – HT5 – HTD 8 – HTD14

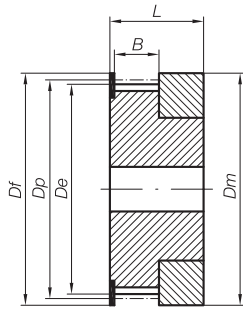

1F

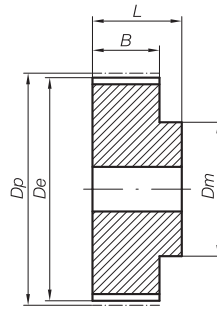

A

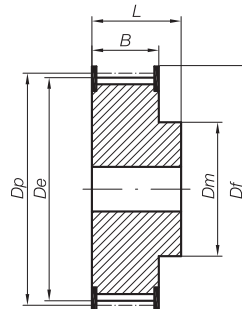

AF

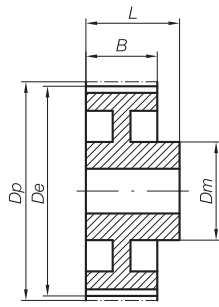

B

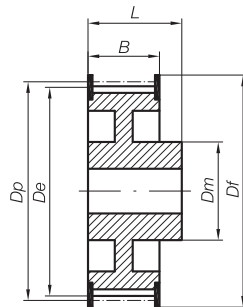

BF

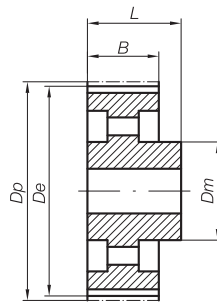

C

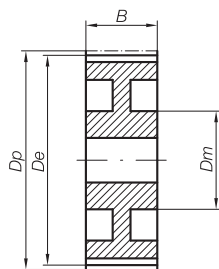

SB

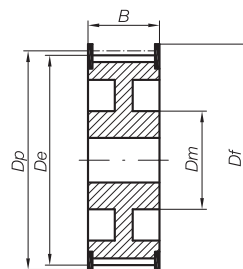

SBF

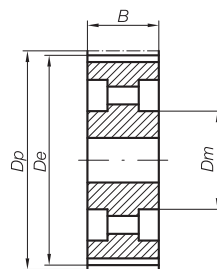

SC

TIMING BARS

Timing bars are toothed steel or aluminium cylinders, available in standard or custom made to drawing.

SECTION

T - AT - HTD

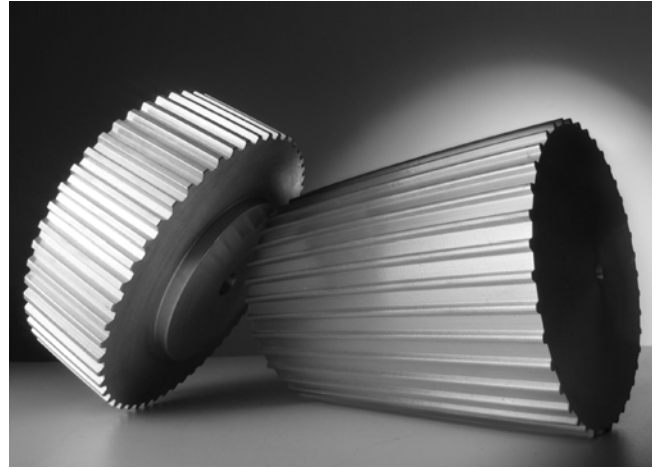
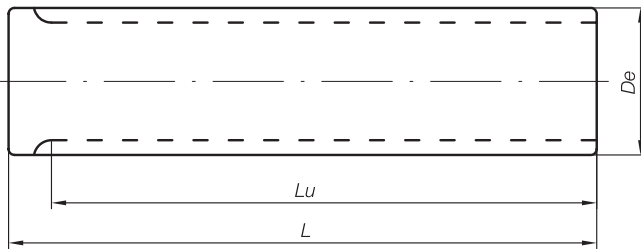

FLANGES FOR PULLEYS

Full selection of stock aluminum and steel timing pulley flanges. Custom-made or standard, our high-quality timing pulley flanges are ideal for:

- Custom pulleys for specific applications;
- Quick and inexpensive prototypes;
- Unique material and performance specifications.



CLAMPING PLATES

Clamping Plates are used to clamp timing belt ends.

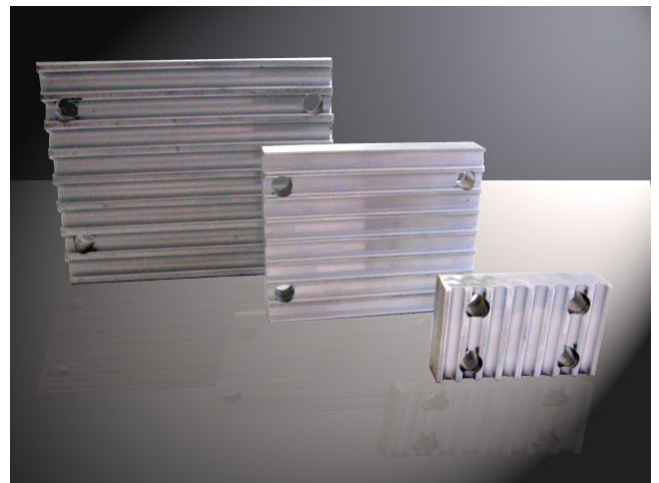
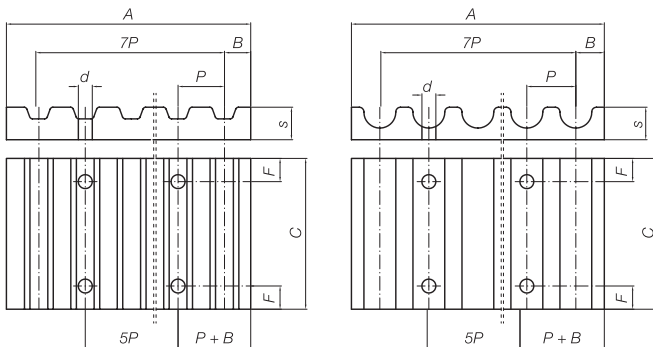

SECTION

XL - L - H - T5 - T10
 T20 - AT5 - AT10 - AT20

SECTION

HTD

METAL Taper Bushes

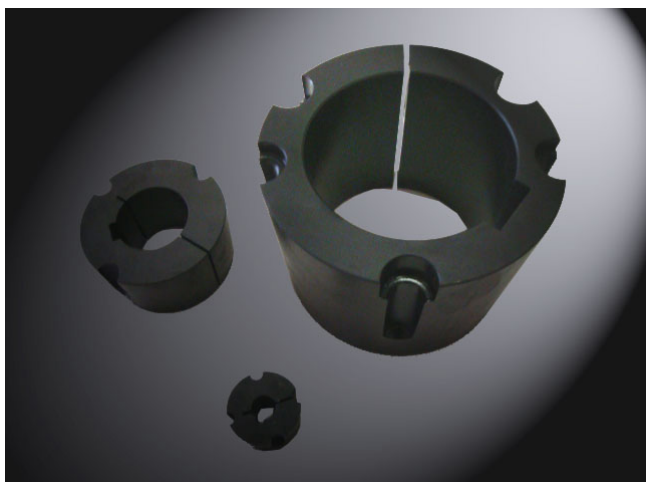

TAPER BUSHES

The taper bushes allow easy mounting and quick removal of the transmission, thus eliminating the clearance between shaft and bore. Megadyne is able to provide a range of different types of taper bushes, each with a wide range of hole diameters and different types of keyway.

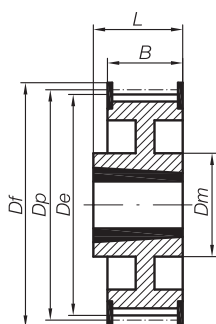

8WF

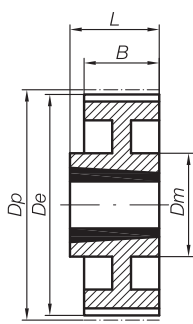

8W

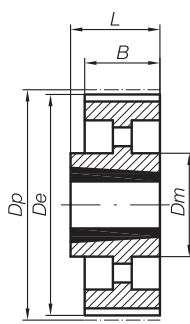

8A

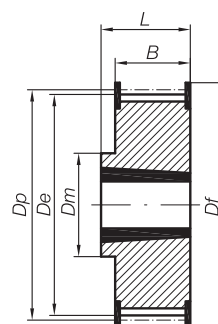

8F

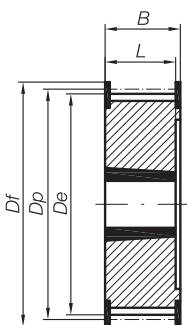

5F

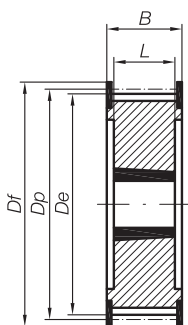

4F

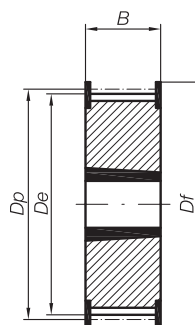

3F

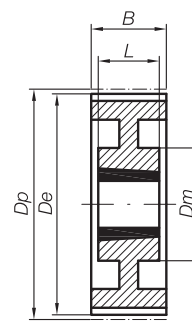

9W

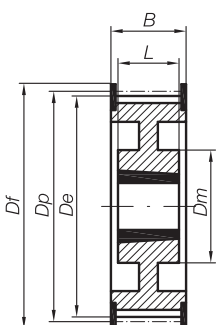

9WF

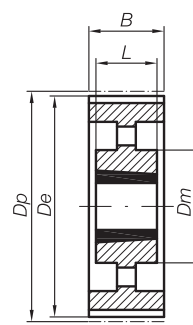

9A

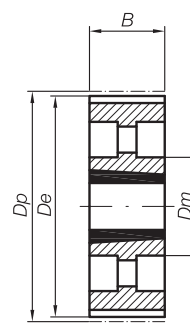

3A

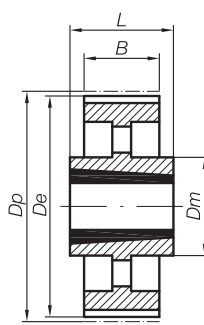

7A

MEGAWELD Thermoweldable belts

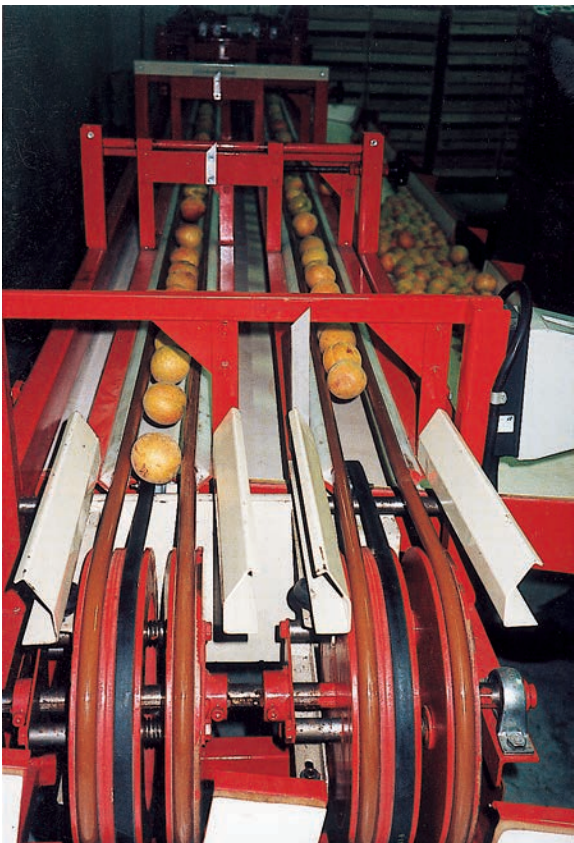

V-belts		
Code	Hardness	Section
PT85 / PTD85	85 ShA	Z / A / B / C / D
PT85RK / PTD85RK	85 ShA	Z / A / B / C / D
PT90 / PTD90	90 ShA	Z / A / B / C / D
PT90RK / PTD90RK	90 ShA	Z / A / B / C / D
PT100 / PTD100	100 ShA – 55 ShD	Z / A / B / C



Round belt		
Code	Hardness	Section
PR85	85 ShA	Ø 3 :- 18 mm
PR85NL	85 ShA	Ø 2 :- 15 mm
PR85RK	85 ShA	Ø 6 :- 18 mm
PR90	90 ShA	Ø 2 :- 18 mm

MEGADYNE DTM MICRO



The **MEGADYNE DTM-MICRO** is used to determine the tension of a drive belt, by measuring the frequency of the static belt. Employing the latest microprocessor technology, offers ease of use with precise measurement results. Measuring the acoustic frequency, this device can be used for all types of Power Transmission belts:

- V-Belts
- Poly V Belts
- Timing Belts
- Etc

The DTM-MICRO can operate regardless of pitch, colour, length, width and reinforcement type. Measuring the frequency produced by the belt, the DTM-MICRO accurately calculates and displays the reading. The frequency is directly proportional to the belt tension. The higher the frequency, the higher the belt tension is. The Kit includes:

- DTM-MICRO Tension Meter
- Sensing Head
- Connector Cable
- Carrying Case
- Instruction Manual



MEGADYNE BELTS MEASURING GAUGE

Measurement range from 500mm to 2500mm internal length (Li).

Megadyne belts measuring gauge can be easily mounted on the wall.

