

SLSE30-750Q8

Light Screen for Machine Safety Applications – Emitter

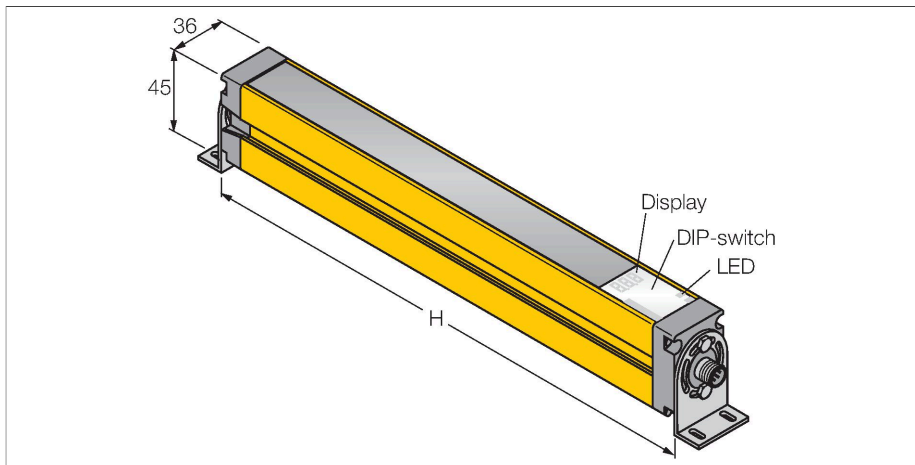

Technical data

Type	SLSE30-750Q8
ID	3072371
Optical data	
Function	Light screen
Light type	IR
Wavelength	950 nm
Optical resolution	30 mm
Range	100...18000 mm
Scan field	750 mm
Number of beams	50
With muting function	no
Scan Code	Adjustable
Electrical data	
Operating voltage	20...28 VDC
Residual ripple	< 10 % U_{ss}
DC rated operational current	≤ 100 mA
Short-circuit protection	yes
Reverse polarity protection	yes
Response time typical	< 17 ms
With restart interlock	yes
Blanking function	yes
Mechanical data	
Design	Rectangular, EZ-Screen
Dimensions	45 x 36 x 821 mm
Housing material	Metal, AL, Yellow polyester
Lens	plastic, Acrylic
Cascadable	No

Features

- Male M12 × 1, 8-pin
- Protection class IP65
- Adjustment via DIP switch
- Operating voltage 24 VDC +15 %
- Resolution 30 mm
- Scan field 750 mm
- All devices incl. 2 EZA-MBK-11 mounting brackets; 900 mm devices and longer additionally incl. 1 EZA-MBK-12
- Personnel safety Cat 4, PL e acc. to EN ISO 13849-1:2008
- Type 4 according to IEC 61496-1,-2
- SIL 3 to IEC 61508

Wiring diagram

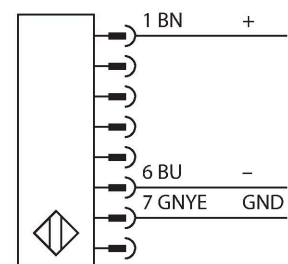

Functional principle

The high-resolution safety light screen for personnel protection consists of an emitter and a receiver. The system is optically synchronized, making the wiring between emitter and receiver redundant. The receiver's safety switching outputs are directly connected to a load relay and trigger an immediate stop of the dangerous machine cycle. Personnel safety degree type 4 acc. to IEC 61496 is fulfilled through 2 channel monitoring of the switching device and the multiple-redundant construction with mutual processor control.

Technical data

Electrical connection	Connector, M12 × 1
Number of cores	8
Ambient temperature	0...+50 °C
Protection class	IP65
Power-on indication	LED, Green
Tests/approvals	
Vibration resistance	10-55 Hz at 0.35 mm
Shock test	10 g at 16 ms (6000 cycles)
Approvals	CE, cULus listed

Accessories

EZA-MBK-11 3071470

Mounting bracket, steel, black-finished, for EZ-ARRAY and EZ-SCREEN standard and cascade 14 & 30 mm

EZA-MBK-12 3071756

Mounting bracket, steel, black-finished, for EZ-ARRAY and EZ-SCREEN standard and cascade 14 & 30 mm

EZA-MBK-20 3072587

Mounting bracket, steel, black-finished, for EZ-ARRAY and EZ-SCREEN standard 14 & 30 mm

Accessories

Dimension drawing	Type	ID	
	QDE-815D	3070883	Connection cable for safety light screens, PVC, yellow, length 4.57 m, female connection, M12 x 1, 8-pin
	QDE-825D	3070884	Connection cable for safety light screens, PVC, yellow, length 7.62 m, female connection, M12 x 1, 8-pin
	QDE-850D	3070885	Connection cable for safety light screens, PVC, yellow, length 15.3 m, female connection, M12 x 1, 8-pin

Dimension drawing	Type	ID	
	QDE-875D	3071466	Connection cable for safety light screens, PVC, yellow, length 22.9 m, female connection, M12 x 1, 8-pin
	QDE-8100D	3071467	Connection cable for safety light screens, PVC, yellow, length 30.5 m, female connection, M12 x 1, 8-pin
	DEE2R-81D	3072205	Connection cable, PVC, yellow, length: 0.31 m, female M12 x 1 - male M12, 8-pin
	DEE2R-83D	3072206	Connection cable, PVC, yellow, length: 0.91 m, female M12 x 1 - male M12, 8-pin
	DEE2R-88D_	3072635	Connection cable, PVC, yellow, length: 2.44 m, female M12 x 1 - male M12, 8-pin
	DEE2R-815D	3072207	Connection cable, PVC, yellow, length: 4.57 m, female M12 x 1 - male M12, 8-pin
	DEE2R-825D	3072208	Connection cable, PVC, yellow, length: 7.62 m, female M12 x 1 - male M12, 8-pin
	DEE2R-850D	3072209	Connection cable, PVC, yellow, length: 15.2 m, female M12 x 1 - male M12, 8-pin
	DEE2R-875D	3072210	Connection cable, PVC, yellow, length: 22.9 m, female M12 x 1 - male M12, 8-pin
	DEE2R-8100D	3072211	Connection cable, PVC, yellow, length: 30.5 m, female M12 x 1 - male M12, 8-pin
	CSB-M1280M1280	3075375	Y-piece, PVC, yellow, with male M12 x 1, 8-pin on 2 x 0.3 m cable, PVC, yellow, with female M12 x 1, 8-pin
	CSB-M1281M1281	3073252	Y-piece, PVC, yellow, length: 0.3 m with male, M12 x 1, 8-pin on 2 x 0.3 m cable, PVC, yellow, with female, M12 x 1, 8-pin
	CSB-M1288M1281	3073253	Y-piece, PVC, yellow, length: 2.5 m with male, M12 x 1, 8-pin on 2 x 0.3 m cable, PVC, yellow, with female, M12 x 1, 8-pin
	CSB-M12815M1281	3073254	Y-piece, PVC, yellow, length: 4.6 m with male, M12 x 1, 8-pin on 2 x 0.3 m cable, PVC, yellow, with female, M12 x 1, 8-pin
	CSB-M12825M1281	3073255	Y-piece, PVC, yellow, length: 7.6 m with male, M12 x 1, 8-pin on 2 x 0.3 m cable, PVC, yellow, with female, M12 x 1, 8-pin
	DEE2R-88D	3094306	Connection cable, PVC, yellow, length: 2.44 m, M12 x 1 female connector, 8-pin, on M12 x 1 male connector, 8-pin