











































# Disconnect Switches



Main/Emergency-Off Switches **Front mounting** Four hole mounting

## Main/Emergency-Off Switches

- Front mounting switches with four hole mounting
- 3 up to 8 pole
- 20 A up to 315 A
- IP66 / IP55



Switching programme	Rated data (IEC 60947)			Mounting dimension  (mm)	Padlock device N-handle yellow/red	Padlock device M-handle yellow/red	Padlockable handle V-handle yellow/red
	Operat. current $I_e$ (A)	Operational power (at 380–440 V)					
		AC-21A	AC-23A		AC-3	IP66	IP66
<b>41300</b> – 3 pole – without auxiliary contacts 	20	5.5	3.7	36 × 36			
	20	5.5	3.7	48 × 48			
	25	7.5	5.5	36 × 36			
	25	7.5	5.5	48 × 48			
	32	11	7.5	36 × 36			
	32	11	7.5	48 × 48			
	40	15	11	36 × 36			
	40	15	11	36 × 36			
	40	15	11	48 × 48			
	40	15	11	48 × 48			
	40	15	11	68 × 68			–
	50	18.5	15	36 × 36			
	50	18.5	15	48 × 48			
	50	18.5	15	68 × 68			–
	63	22	18.5	36 × 36			
	63	22	18.5	48 × 48			
	63	22	18.5	48 × 48			
	63	22	18.5	68 × 68			–
	63	22	18.5	68 × 68			–
	80	30	22	48 × 48			
80	30	22	68 × 68			–	
100	37	30	48 × 48				
100	37	30	68 × 68			–	
125	45	37	48 × 48				
125	45	37	68 × 68			–	

Rated data (IEC 60947)			Mounting dimension  (mm)	Padlock device H-handle yellow/red
Operat. current $I_e$ (A)	Operational power (at 380–440 V)			
AC-21A	AC-23A	AC-3		IP55
160	75	45	68 × 68	
315	132	55	104 × 104	



\* larger terminal capacity, see page 154

Further switching programmes from page 132.

# Disconnect Switches

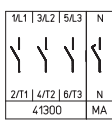

## Main/Emergency-Off Switches Front mounting Four hole mounting

Switching programme	Rated data (IEC 60947)			Mounting dimension  (mm)	Padlock device N-handle yellow/red	Padlock device M-handle yellow/red	Padlockable handle V-handle yellow/red
	Operat. current $I_e$	Operational power (at 380–440 V)			 IP66	 IP66	 IP66
	AC-21A (A)	AC-23A (kW)	AC-3 (kW)		Order code number	Order code number	Order code number
<b>41400</b> – 4 pole – without auxiliary contacts – neutral contact – early make/late break  	20	5.5	3.7	36 × 36	<b>H216-41400-033N4</b>	<b>H216-41400-033M4</b>	<b>H216-41400-033V4</b>
	20	5.5	3.7	48 × 48	<b>H216-41400-036N4</b>	<b>H216-41400-036M4</b>	<b>H216-41400-036V4</b>
	25	7.5	5.5	36 × 36	<b>H220-41400-033N4</b>	<b>H220-41400-033M4</b>	<b>H220-41400-033V4</b>
	25	7.5	5.5	48 × 48	<b>H220-41400-036N4</b>	<b>H220-41400-036M4</b>	<b>H220-41400-036V4</b>
	32	11	7.5	36 × 36	<b>H226-41400-033N4</b>	<b>H226-41400-033M4</b>	<b>H226-41400-033V4</b>
	32	11	7.5	48 × 48	<b>H226-41400-036N4</b>	<b>H226-41400-036M4</b>	<b>H226-41400-036V4</b>
	40	15	11	36 × 36	<b>H233-41400-033N4</b>	<b>H233-41400-033M4</b>	<b>H233-41400-033V4</b>
	40	15	11	36 × 36	<b>B240-41400-033N4*</b>	<b>B240-41400-033M4*</b>	<b>B240-41400-033V4*</b>
	40	15	11	48 × 48	<b>H233-41400-036N4</b>	<b>H233-41400-036M4</b>	<b>H233-41400-036V4</b>
	40	15	11	48 × 48	<b>B240-41400-036N4*</b>	<b>B240-41400-036M4*</b>	<b>B240-41400-036V4*</b>
	40	15	11	68 × 68	<b>B240-41400-136N4</b>	<b>B240-41400-136M4</b>	–
	50	18.5	15	36 × 36	<b>B250-41400-033N4</b>	<b>B250-41400-033M4</b>	<b>B250-41400-033V4</b>
	50	18.5	15	48 × 48	<b>B250-41400-036N4</b>	<b>B250-41400-036M4</b>	<b>B250-41400-036V4</b>
	50	18.5	15	68 × 68	<b>B250-41400-136N4</b>	<b>B250-41400-136M4</b>	–
	63	22	18.5	36 × 36	<b>B263-41400-033N4</b>	<b>B263-41400-033M4</b>	<b>B263-41400-033V4</b>
	63	22	18.5	48 × 48	<b>B263-41400-036N4</b>	<b>B263-41400-036M4</b>	<b>B263-41400-036V4</b>
	63	22	18.5	48 × 48	<b>H406-41400-033N4*</b>	<b>H406-41400-033M4*</b>	<b>H406-41400-033V4*</b>
	63	22	18.5	68 × 68	<b>B263-41400-136N4</b>	<b>B263-41400-136M4</b>	–
	63	22	18.5	68 × 68	<b>H406-41400-036N4*</b>	<b>H406-41400-036M4*</b>	–
	80	30	22	48 × 48	<b>H408-41400-033N4</b>	<b>H408-41400-033M4</b>	<b>H408-41400-033V4</b>
80	30	22	68 × 68	<b>H408-41400-036N4</b>	<b>H408-41400-036M4</b>	–	
100	37	30	48 × 48	<b>H410-41400-033N4</b>	<b>H410-41400-033M4</b>	<b>H410-41400-033V4</b>	
100	37	30	68 × 68	<b>H410-41400-036N4</b>	<b>H410-41400-036M4</b>	–	
125	45	37	48 × 48	<b>H412-41400-033N4</b>	<b>H412-41400-033M4</b>	<b>H412-41400-033V4</b>	
125	45	37	68 × 68	<b>H412-41400-036N4</b>	<b>H412-41400-036M4</b>	–	

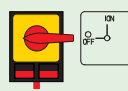

Rated data (IEC 60947)			Mounting dimension  (mm)	Padlock device H-handle yellow/red
Operat. current $I_e$	Operational power (at 380–440 V)			 IP55
AC-21A (A)	AC-23A (kW)	AC-3 (kW)		Order code number
160	75	45	68 × 68	<b>K616-41400-033H4</b>
315	132	55	104 × 104	<b>K830-41400-033H4</b>

\* larger terminal capacity, see page 154

Further switching programmes from page 132.

# Disconnect Switches

## Main/Emergency-Off Switches Front mounting Four hole mounting

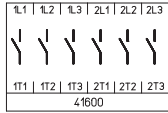

Switching programme	Rated data (IEC 60947)			Mounting dimension  (mm)	Padlock device N-handle yellow/red	Padlock device M-handle yellow/red	Padlockable handle V-handle yellow/red
	Operat. current $I_e$  AC-21A (A)	Operational power (at 380–440 V)			 IP66	 IP66	 IP66
		AC-23A (kW)	AC-3 (kW)				
<b>41600</b> – 6 pole – without auxiliary contacts 	20	5.5	3.7	36 × 36	<b>H216-41600-033N4</b>	<b>H216-41600-033M4</b>	–
	20	5.5	3.7	48 × 48	<b>H216-41600-036N4</b>	<b>H216-41600-036M4</b>	<b>H216-41600-036V4</b>
	20	5.5	3.7	68 × 68	<b>H216-41600-136N4</b>	<b>H216-41600-136M4</b>	–
	25	7.5	5.5	36 × 36	<b>H220-41600-033N4</b>	<b>H220-41600-033M4</b>	–
	25	7.5	5.5	48 × 48	<b>H220-41600-036N4</b>	<b>H220-41600-036M4</b>	<b>H220-41600-036V4</b>
	25	7.5	7.5	68 × 68	<b>H220-41600-136N4</b>	<b>H220-41600-136M4</b>	–
	32	11	7.5	36 × 36	<b>H226-41600-033N4</b>	<b>H226-41600-033M4</b>	–
	32	11	7.5	48 × 48	<b>H226-41600-036N4</b>	<b>H226-41600-036M4</b>	<b>H226-41600-036V4</b>
	32	11	7.5	68 × 68	<b>H226-41600-136N4</b>	<b>H226-41600-136M4</b>	–
	40	15	11	36 × 36	<b>H233-41600-033N4</b>	<b>H233-41600-033M4</b>	–
	40	15	11	36 × 36	<b>B240-41600-033N4*</b>	<b>B240-41600-033M4*</b>	–
	40	15	11	48 × 48	<b>H233-41600-036N4</b>	<b>H233-41600-036M4</b>	<b>H233-41600-036V4</b>
	40	15	11	48 × 48	<b>B240-41600-036N4*</b>	<b>B240-41600-036M4*</b>	<b>B240-41600-036V4</b>
	40	15	11	68 × 68	<b>H233-41600-136N4</b>	<b>H233-41600-136M4</b>	–
	40	15	11	68 × 68	<b>B240-41600-136N4*</b>	<b>B240-41600-136M4*</b>	–
	50	18.5	15	36 × 36	<b>B250-41600-033N4</b>	<b>B250-41600-033M4</b>	–
	50	18.5	15	48 × 48	<b>B250-41600-036N4</b>	<b>B250-41600-036M4</b>	<b>B250-41600-036V4</b>
	50	18.5	15	68 × 68	<b>B250-41600-136N4</b>	<b>B250-41600-136M4</b>	–
	63	22	18.5	36 × 36	<b>B263-41600-033N4</b>	<b>B263-41600-033M4</b>	–
	63	22	18.5	48 × 48	<b>B263-41600-036N4</b>	<b>B263-41600-036M4</b>	<b>B263-41600-036V4</b>
	63	22	18.5	48 × 48	<b>H406-41600-033N4*</b>	<b>H406-41600-033M4*</b>	<b>H406-41600-033V4*</b>
	63	22	18.5	68 × 68	<b>B263-41600-136N4</b>	<b>B263-41600-136M4</b>	–
	63	22	18.5	68 × 68	<b>H406-41600-036N4*</b>	<b>H406-41600-036M4*</b>	–
	80	30	22	48 × 48	<b>H408-41600-033N4</b>	<b>H408-41600-033M4</b>	<b>H408-41600-033V4</b>
80	30	22	68 × 68	<b>H408-41600-036N4</b>	<b>H408-41600-036M4</b>	–	
100	37	30	48 × 48	<b>H410-41600-033N4</b>	<b>H410-41600-033M4</b>	<b>H410-41600-033V4</b>	
100	37	30	68 × 68	<b>H410-41600-036N4</b>	<b>H410-41600-036M4</b>	–	
125	45	37	48 × 48	<b>H412-41600-033N4</b>	<b>H412-41600-033M4</b>	<b>H412-41600-033V4</b>	
125	45	37	68 × 68	<b>H412-41600-036N4</b>	<b>H412-41600-036M4</b>	–	

Rated data (IEC 60947)			Mounting dimension  (mm)	Padlock device H-handle yellow/red
Operat. current $I_e$  AC-21A (A)	Operational power (at 380–440 V)			 IP55
	AC-23A (kW)	AC-3 (kW)	Order code number	
160	75	45	68 × 68	<b>K616-41600-033H4</b>
315	132	55	104 × 104	<b>K830-41600-033H4</b>

\* larger terminal capacity, see page 154

Further switching programmes from page 132.

Switching programme	Rated data (IEC 60947)			Mounting dimension  (mm)	Padlock device N-handle yellow/red	Padlock device M-handle yellow/red	Padlockable handle V-handle yellow/red
	Operat. current $I_e$	Operational power (at 380–440 V)					
		AC-21A (A)	AC-23A (kW)		AC-3 (kW)	IP66	IP66
				Order code number	Order code number	Order code number	
<b>41800</b> – 8 pole – without auxiliary contacts – 2 neutral contacts early make/late break 	20	5.5	3.7	36 × 36	<b>H216-41800-033N4</b>	<b>H216-41800-033M4</b>	–
	20	5.5	3.7	48 × 48	<b>H216-41800-036N4</b>	<b>H216-41800-036M4</b>	<b>H216-41800-036V4</b>
	20	5.5	3.7	68 × 68	<b>H216-41800-136N4</b>	<b>H216-41800-136M4</b>	–
	25	7.5	5.5	36 × 36	<b>H220-41800-033N4</b>	<b>H220-41800-033M4</b>	–
	25	7.5	5.5	48 × 48	<b>H220-41800-036N4</b>	<b>H220-41800-036M4</b>	<b>H220-41800-036V4</b>
	25	7.5	5.5	68 × 68	<b>H220-41800-136N4</b>	<b>H220-41800-136M4</b>	–
	32	11	7.5	36 × 36	<b>H226-41800-033N4</b>	<b>H226-41800-033M4</b>	–
	32	11	7.5	48 × 48	<b>H226-41800-036N4</b>	<b>H226-41800-036M4</b>	<b>H226-41800-036V4</b>
	32	11	7.5	68 × 68	<b>H226-41800-136N4</b>	<b>H226-41800-136M4</b>	–
	40	15	11	36 × 36	<b>H233-41800-033N4</b>	<b>H233-41800-033M4</b>	–
	40	15	11	36 × 36	<b>B240-41800-033N4*</b>	<b>B240-41800-033M4*</b>	–
	40	15	11	48 × 48	<b>H233-41800-036N4</b>	<b>H233-41800-036M4</b>	<b>H233-41800-036V4</b>
	40	15	11	48 × 48	<b>B240-41800-036N4*</b>	<b>B240-41800-036M4*</b>	<b>B240-41800-036V4*</b>
	40	15	11	68 × 68	<b>H233-41800-136N4</b>	<b>H233-41800-136M4</b>	–
	40	15	11	68 × 68	<b>B240-41800-136N4*</b>	<b>B240-41800-136M4*</b>	–
	50	18.5	15	36 × 36	<b>B250-41800-033N4</b>	<b>B250-41800-033M4</b>	–
	50	18.5	15	48 × 48	<b>B250-41800-036N4</b>	<b>B250-41800-036M4</b>	<b>B250-41800-036V4</b>
	50	18.5	15	68 × 68	<b>B250-41800-136N4</b>	<b>B250-41800-136M4</b>	–
	63	22	18.5	36 × 36	<b>B263-41800-033N4</b>	<b>B263-41800-033M4</b>	–
	63	22	18.5	48 × 48	<b>B263-41800-036N4</b>	<b>B263-41800-036M4</b>	<b>B263-41800-036V4</b>
63	22	18.5	48 × 48	<b>H406-41800-033N4*</b>	<b>H406-41800-033M4*</b>	<b>H406-41800-033V4*</b>	
63	22	18.5	68 × 68	<b>B263-41800-136N4</b>	<b>B263-41800-136M4</b>	–	
63	22	18.5	68 × 68	<b>H406-41800-036N4*</b>	<b>H406-41800-036M4*</b>	–	
80	30	22	48 × 48	<b>H408-41800-033N4</b>	<b>H408-41800-033M4</b>	<b>H408-41800-033V4</b>	
80	30	22	68 × 68	<b>H408-41800-036N4</b>	<b>H408-41800-036M4</b>	–	
100	37	30	48 × 48	<b>H410-41800-033N4</b>	<b>H410-41800-033M4</b>	<b>H410-41800-033V4</b>	
100	37	30	68 × 68	<b>H410-41800-036N4</b>	<b>H410-41800-036M4</b>	–	
125	45	37	48 × 48	<b>H412-41800-033N4</b>	<b>H412-41800-033M4</b>	<b>H412-41800-033V4</b>	
125	45	37	68 × 68	<b>H412-41800-036N4</b>	<b>H412-41800-036M4</b>	–	

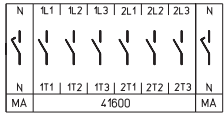
Rated data (IEC 60947)			Mounting dimension  (mm)	Padlock device H-handle yellow/red
Operat. current $I_e$	Operational power (at 380–440 V)			
	AC-21A (A)	AC-23A (kW)	AC-3 (kW)	IP55
				Order code number
160	75	45	68 × 68	<b>K616-41800-033H4</b>
315	132	55	104 × 104	<b>K830-41800-033H4</b>

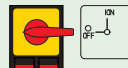
\* larger terminal capacity, see page 154

Further switching programmes from page 132.

# Disconnect Switches

Main/Emergency-Off Switches **Front mounting** Four hole mounting

Dimensions in mm:

**Setup of order code number**

Type	Switching progr.	Mtg. form
H216	41800	036N4
Order code no.	<b>H216-41800-036N4</b>	

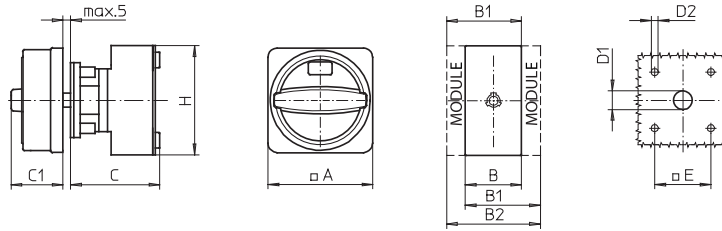

**Switching programmes 3 and 4 pole**

Types H216 / H220 / H226 / H233:

Mtg. form	A	B	B1	B2	C	C1	D1	D2	E	H
033M4	67	36	48	60	58	38	15	4.5	36	70
033N4	67	36	48	60	58	33	15	4.5	36	70
033V4	48	36	48	60	58	32	12	4.5	36	70
036M4	67	36	48	60	58	38	15	5	48	70
036N4	67	36	48	60	58	33	15	5	48	70
036V4	64	36	48	60	58	39	15	5	48	70

Types B240 / B250 / B263:

Mtg. form	A	B	B1	B2	C	C1	D1	D2	E	H
033M4	67	50	69	88	58	38	15	4.5	36	72
033N4	67	50	69	88	58	33	15	4.5	36	72
033V4	48	50	69	88	58	32	12	4.5	36	72
036M4	67	50	69	88	58	38	15	5	48	72
036N4	67	50	69	88	58	33	15	5	48	72
036V4	64	50	69	88	58	39	15	5	48	72
136M4	88	50	69	88	58	50	15	5.5	68	72
136N4	88	50	69	88	58	45	15	5.5	68	72

Types H406 / H408 / H410 / H412:

Mtg. form	A	B	B1	B2	C	C1	D1	D2	E	H
033M4	88	70	89	108	73	50	15	5	48	80
033N4	88	70	89	108	73	45	15	5	48	80
033V4	64	70	89	108	73	39	15	5	48	80
036M4	88	70	89	108	73	50	15	5.5	68	80
036N4	88	70	89	108	73	45	15	5.5	68	80

**Switching programmes 6 and 8 pole**

Types H216 / H220 / H226 / H233:

Mtg. form	A	B	B1	B2	C	C1	D1	D2	E	H
033M4	67	72	84	96	66	38	15	4.5	36	70
033N4	67	72	84	96	66	33	15	4.5	36	70
036M4	67	72	84	96	66	38	15	5	48	70
036N4	67	72	84	96	66	33	15	5	48	70
036V4	64	72	84	96	66	39	15	5	48	70
136M4	88	72	84	96	66	38	15	5.5	68	70
136N4	88	72	84	96	66	33	15	5.5	68	70

Types B240 / B250 / B263:

Mtg. form	A	B	B1	B2	C	C1	D1	D2	E	H
033M4	67	100	119	138	70	38	15	4.5	36	72
033N4	67	100	119	138	70	33	15	4.5	36	72
036M4	67	100	119	138	70	38	15	5	48	72
036N4	67	100	119	138	70	33	15	5	48	72
036V4	64	100	119	138	70	39	15	5	48	72
136M4	88	100	119	138	70	50	15	5.5	68	72
136N4	88	100	119	138	70	45	15	5.5	68	72

Types H406 / H408 / H410 / H412:

Mtg. form	A	B	B1	B2	C	C1	D1	D2	E	H
033M4	88	140	159	178	86	50	15	5	48	80
033N4	88	140	159	178	86	45	15	5	48	80
033V4	64	140	159	178	86	39	15	5	48	80
036M4	88	140	159	178	86	50	15	5.5	68	80
036N4	88	140	159	178	86	45	15	5.5	68	80

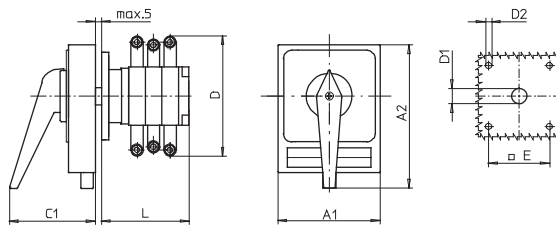

Types K616 / K830:

Type	Mtg. form	Switching progr.	A1	A2	C1	D*	D1	D2	E	L
K616	033H4	41300	98	142	83	150	20	5.5	68	104
K616	033H4	41400	98	142	83	150	20	5.5	68	104
K830	033H4	41300	130	178	93	210	20	5.5	104	125
K830	033H4	41400	130	178	93	210	20	5.5	104	125

Types K616 / K830:

Type	Mtg. form	Switching progr.	A1	A2	C1	D*	D1	D2	E	L
K616	033H4	41600	98	142	83	150	20	5.5	68	136
K616	033H4	41800	98	142	83	150	20	5.5	68	168
K830	033H4	41600	130	178	93	210	20	5.5	104	161
K830	033H4	41800	130	178	93	210	20	5.5	104	197



Further switching programmes and corresponding dimensions for types K on request.

\* terminal lugs included

## Main/Emergency-Off Switches

- Front mounting switches with single hole mounting
- 3 up to 8 pole
- 20 A up to 63 A
- IP66



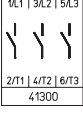
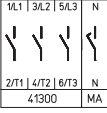

Switching programme	Rated data (IEC 60947)			Mounting dimension  (mm)	Padlock device N-handle yellow/red	Padlock device M-handle yellow/red	Padlockable handle V-handle yellow/red
	Operat. current $I_e$	Operational power (at 380–440 V)			 OFF ON	 OFF ON	 OFF ON
	AC-21A (A)	AC-23A (kW)	AC-3 (kW)		IP66	IP66	IP66
					Order code number	Order code number	Order code number
<b>41300</b> – 3 pole – without auxiliary contacts  	20	5.5	3.7	∅ 22.5	H216-41300-206N4	H216-41300-206M4	H216-41300-206V4
	20	5.5	3.7	∅ 30.5	H216-41300-216N4	H216-41300-216M4	H216-41300-216V4
	25	7.5	5.5	∅ 22.5	H220-41300-206N4	H220-41300-206M4	H220-41300-206V4
	25	7.5	5.5	∅ 30.5	H220-41300-216N4	H220-41300-216M4	H220-41300-216V4
	32	11	7.5	∅ 22.5	H226-41300-206N4	H226-41300-206M4	H226-41300-206V4
	32	11	7.5	∅ 30.5	H226-41300-216N4	H226-41300-216M4	H226-41300-216V4
	40	15	11	∅ 22.5	H233-41300-206N4	H233-41300-206M4	H233-41300-206V4
	40	15	11	∅ 22.5	B240-41300-206N4*	B240-41300-206M4*	B240-41300-206V4*
	40	15	11	∅ 30.5	H233-41300-216N4	H233-41300-216M4	H233-41300-216V4
	40	15	11	∅ 30.5	B240-41300-216N4*	B240-41300-216M4*	B240-41300-216V4*
	50	18.5	15	∅ 22.5	B250-41300-206N4	B250-41300-206M4	B250-41300-206V4
	50	18.5	15	∅ 30.5	B250-41300-216N4	B250-41300-216M4	B250-41300-216V4
	63	22	18.5	∅ 22.5	B263-41300-206N4	B263-41300-206M4	B263-41300-206V4
	63	22	18.5	∅ 30.5	B263-41300-216N4	B263-41300-216M4	B263-41300-216V4
<b>41400</b> – 4 pole – without auxiliary contacts – neutral contact early make/late break  	20	5.5	3.7	∅ 22.5	H216-41400-206N4	H216-41400-206M4	H216-41400-206V4
	20	5.5	3.7	∅ 30.5	H216-41400-216N4	H216-41400-216M4	H216-41400-216V4
	25	7.5	5.5	∅ 22.5	H220-41400-206N4	H220-41400-206M4	H220-41400-206V4
	25	7.5	5.5	∅ 30.5	H220-41400-216N4	H220-41400-216M4	H220-41400-216V4
	32	11	7.5	∅ 22.5	H226-41400-206N4	H226-41400-206M4	H226-41400-206V4
	32	11	7.5	∅ 30.5	H226-41400-216N4	H226-41400-216M4	H226-41400-216V4
	40	15	11	∅ 22.5	H233-41400-206N4	H233-41400-206M4	H233-41400-206V4
	40	15	11	∅ 22.5	B240-41400-206N4*	B240-41400-206M4*	B240-41400-206V4*
	40	15	11	∅ 30.5	H233-41400-216N4	H233-41400-216M4	H233-41400-216V4
	40	15	11	∅ 30.5	B240-41400-216N4*	B240-41400-216M4*	B240-41400-216V4*
	50	18.5	15	∅ 22.5	B250-41400-206N4	B250-41400-206M4	B250-41400-206V4
	50	18.5	15	∅ 30.5	B250-41400-216N4	B250-41400-216M4	B250-41400-216V4
	63	22	18.5	∅ 22.5	B263-41400-206N4	B263-41400-206M4	B263-41400-206V4
	63	22	18.5	∅ 30.5	B263-41400-216N4	B263-41400-216M4	B263-41400-216V4

\* larger terminal capacity, see page 154

Further switching programmes from page 132.

# Disconnect Switches

Main/Emergency-Off Switches **Front mounting** Single hole mounting

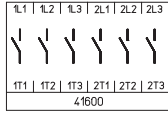
Switching programme	Rated data (IEC 60947)			Mounting dimension  (mm)	Padlock device N-handle yellow/red	Padlock device M-handle yellow/red	Padlockable handle V-handle yellow/red
	Operat. current $I_e$	Operational power (at 380–440 V)			 IP66	 IP66	 IP66
	AC-21A (A)	AC-23A (kW)	AC-3 (kW)		Order code number	Order code number	Order code number
<b>41600</b> – 6 pole – without auxiliary contacts 	20	5.5	3.7	∅ 22.5	<b>H216-41600-206N4</b>	<b>H216-41600-206M4</b>	–
	20	5.5	3.7	∅ 30.5	<b>H216-41600-216N4</b>	<b>H216-41600-216M4</b>	<b>H216-41600-216V4</b>
	25	7.5	5.5	∅ 22.5	<b>H220-41600-206N4</b>	<b>H220-41600-206M4</b>	–
	25	7.5	5.5	∅ 30.5	<b>H220-41600-216N4</b>	<b>H220-41600-216M4</b>	<b>H220-41600-216V4</b>
	32	11	7.5	∅ 22.5	<b>H226-41600-206N4</b>	<b>H226-41600-206M4</b>	–
	32	11	7.5	∅ 30.5	<b>H226-41600-216N4</b>	<b>H226-41600-216M4</b>	<b>H226-41600-216V4</b>
	40	15	11	∅ 22.5	<b>H233-41600-206N4</b>	<b>H233-41600-206M4</b>	–
	40	15	11	∅ 30.5	<b>H233-41600-216N4</b>	<b>H233-41600-216M4</b>	<b>H233-41600-216V4</b>

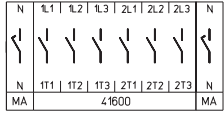
<b>41800</b> – 8 pole – without auxiliary contacts – 2 neutral contacts early make/late break 	20	5.5	3.7	∅ 22.5	<b>H216-41800-206N4</b>	<b>H216-41800-206M4</b>	–
	20	5.5	3.7	∅ 30.5	<b>H216-41800-216N4</b>	<b>H216-41800-216M4</b>	<b>H216-41800-216V4</b>
	25	7.5	5.5	∅ 22.5	<b>H220-41800-206N4</b>	<b>H220-41800-206M4</b>	–
	25	7.5	5.5	∅ 30.5	<b>H220-41800-216N4</b>	<b>H220-41800-216M4</b>	<b>H220-41800-216V4</b>
	32	11	7.5	∅ 22.5	<b>H226-41800-206N4</b>	<b>H226-41800-206M4</b>	–
	32	11	7.5	∅ 30.5	<b>H226-41800-216N4</b>	<b>H226-41800-216M4</b>	<b>H226-41800-216V4</b>
	40	15	11	∅ 22.5	<b>H233-41800-206N4</b>	<b>H233-41800-206M4</b>	–
	40	15	11	∅ 30.5	<b>H233-41800-216N4</b>	<b>H233-41800-216M4</b>	<b>H233-41800-216V4</b>

Further switching programmes from page 132.

## Dimensions in mm:

Setup of order code number		
Type	Switching progr.	Mtg. form
H226	41300	206N4
Order code no.	<b>H226-41300-206N4</b>	

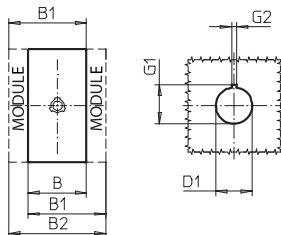
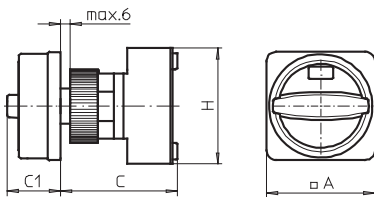

### Switching programmes 3 and 4 pole

Types H216 / H220 / H226 / H233:

Mtg. form	A	B	B1	B2	C	C1	D1	G1	G2	H
206M4	67	36	48	60	75	38	22.5	24.2	3.2	70
206N4	67	36	48	60	75	33	22.5	24.2	3.2	70
206V4	48	36	48	60	75	32	22.5	24.2	3.2	70
216M4	67	36	48	60	75	38	30.5	33	4.8	70
216N4	67	36	48	60	75	33	30.5	33	4.8	70
216V4	64	36	48	60	75	39	30.5	33	4.8	70

Types B240 / B250 / B263:

Mtg. form	A	B	B1	B2	C	C1	D1	G1	G2	H
206M4	67	50	69	88	75	38	22.5	24.2	3.2	72
206N4	67	50	69	88	75	33	22.5	24.2	3.2	72
206V4	48	50	69	88	75	32	22.5	24.2	3.2	72
216M4	67	50	69	88	75	38	30.5	33	4.8	72
216N4	67	50	69	88	75	33	30.5	33	4.8	72
216V4	64	50	69	88	75	39	30.5	33	4.8	72

### Switching programmes 6 and 8 pole



Types H216 / H220 / H226 / H233:

Mtg. form	A	B	B1	B2	C	C1	D1	G1	G2	H
206M4	67	72	84	96	83	38	22.5	24.2	3.2	70
206N4	67	72	84	96	83	33	22.5	24.2	3.2	70
216M4	67	72	84	96	83	38	30.5	33	4.8	70
216N4	67	72	84	96	83	33	30.5	33	4.8	70
216V4	64	72	84	96	83	39	30.5	33	4.8	70

## Main/Emergency-Off Switches

- Base mounting switches with snap-on mounting
- for DIN rail
- 3 up to 8 pole
- 20 A up to 125 A
- IP30

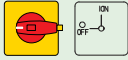

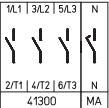
Switching programme	Rated data (IEC 60947)			Escutcheon dimension for 45 mm aperture in Panel/Distribution boards (H × W)  (mm)	Padlockable handle V-handle yellow/red   IP30	Order code number
	Operat. current I <sub>e</sub>	Operational power (at 380–440 V)				
	AC-21A (A)	AC-23A (kW)	AC-3 (kW)			
<b>41300</b> – 3 pole – without auxiliary contacts  	20	5.5	3.7	45 × 48	<b>H216-41300-026V4</b>	
	20	5.5	3.7	45 × 60	<b>H216-41300-126V4</b>	
	25	7.5	5.5	45 × 48	<b>H220-41300-026V4</b>	
	25	7.5	5.5	45 × 60	<b>H220-41300-126V4</b>	
	32	11	7.5	45 × 48	<b>H226-41300-026V4</b>	
	32	11	7.5	45 × 60	<b>H226-41300-126V4</b>	
	40	15	11	45 × 48	<b>H233-41300-026V4</b>	
	40	15	11	45 × 52.5	<b>B240-41300-026V4*</b>	
	40	15	11	45 × 60	<b>H233-41300-126V4</b>	
	50	18.5	15	45 × 52.5	<b>B250-41300-026V4</b>	
	63	22	18.5	45 × 52.5	<b>B263-41300-026V4</b>	
	63	22	18.5	45 × 72	<b>H406-41300-126V4*</b>	
	80	30	22	45 × 72	<b>H408-41300-126V4</b>	
	100	37	30	45 × 72	<b>H410-41300-126V4</b>	
125	45	37	45 × 72	<b>H412-41300-126V4</b>		
<b>41400</b> – 4 pole – without auxiliary contacts – neutral contact early make/late break  	20	5.5	3.7	45 × 48	<b>H216-41400-026V4</b>	
	20	5.5	3.7	45 × 60	<b>H216-41400-126V4</b>	
	25	7.5	5.5	45 × 48	<b>H220-41400-026V4</b>	
	25	7.5	5.5	45 × 60	<b>H220-41400-126V4</b>	
	32	11	7.5	45 × 48	<b>H226-41400-026V4</b>	
	32	11	7.5	45 × 60	<b>H226-41400-126V4</b>	
	40	15	11	45 × 48	<b>H233-41400-026V4</b>	
	40	15	11	45 × 52.5	<b>B240-41400-026V4*</b>	
	40	15	11	45 × 60	<b>H233-41400-126V4</b>	
	50	18.5	15	45 × 52.5	<b>B250-41400-026V4</b>	
	63	22	18.5	45 × 52.5	<b>B263-41400-026V4</b>	
	63	22	18.5	45 × 72	<b>H406-41400-126V4*</b>	
	80	30	22	45 × 72	<b>H408-41400-126V4</b>	
	100	37	30	45 × 72	<b>H410-41400-126V4</b>	
125	45	37	45 × 72	<b>H412-41400-126V4</b>		

\* larger terminal capacity, see page 154

Further switching programmes from page 132.



# Disconnect Switches

Main/Emergency-Off Switches **Base mounting** Snap-on mounting for DIN rail

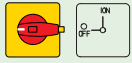
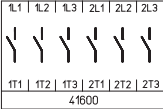
Switching programme	Rated data (IEC 60947)			Escutcheon dimension for 45 mm aperture in Panel/Distribution boards (H × W)  (mm)	Padlockable handle V-handle yellow/red  IP30	Order code number
	Operat. current I <sub>e</sub>	Operational power (at 380–440 V)				
	AC-21A (A)	AC-23A (kW)	AC-3 (kW)			
<b>41600</b> – 6 pole – without auxiliary contacts 	20	5.5	3.7	45 × 76	<b>H216-41600-026V4</b>	
	25	7.5	5.5	45 × 76	<b>H220-41600-026V4</b>	
	32	11	7.5	45 × 76	<b>H226-41600-026V4</b>	
	40	15	11	45 × 76	<b>H233-41600-026V4</b>	
	40	15	11	45 × 105	<b>B240-41600-026V4*</b>	
	50	18.5	15	45 × 105	<b>B250-41600-026V4</b>	
	63	22	18.5	45 × 105	<b>B263-41600-026V4</b>	
	63	22	18.5	45 × 72	<b>H406-41600-126V4*</b>	
	80	30	22	45 × 72	<b>H408-41600-126V4</b>	
	100	37	30	45 × 72	<b>H410-41600-126V4</b>	
	125	45	37	45 × 72	<b>H412-41600-126V4</b>	

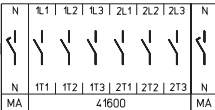
<b>41800</b> – 8 pole – without auxiliary contacts – 2 neutral contacts early make/late break 	20	5.5	3.7	45 × 76	<b>H216-41800-026V4</b>	
	25	7.5	5.5	45 × 76	<b>H220-41800-026V4</b>	
	32	11	7.5	45 × 76	<b>H226-41800-026V4</b>	
	40	15	11	45 × 76	<b>H233-41800-026V4</b>	
	40	15	11	45 × 105	<b>B240-41800-026V4*</b>	
	50	18.5	15	45 × 105	<b>B250-41800-026V4</b>	
	63	22	18.5	45 × 105	<b>B263-41800-026V4</b>	
	63	22	18.5	45 × 72	<b>H406-41800-126V4*</b>	
	80	30	22	45 × 72	<b>H408-41800-126V4</b>	
	100	37	30	45 × 72	<b>H410-41800-126V4</b>	
	125	45	37	45 × 72	<b>H412-41800-126V4</b>	

\* larger terminal capacity, see page 154  
Further switching programmes from page 132.

## Dimensions in mm:

Setup of order code number		
Type	Switching progr.	Mtg. form
H216	41300	026V4
Order code no.	<b>H216-41300-026V4</b>	

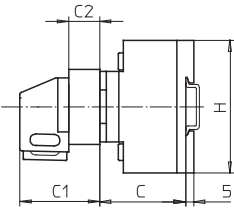
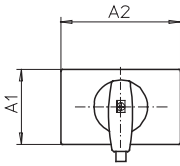
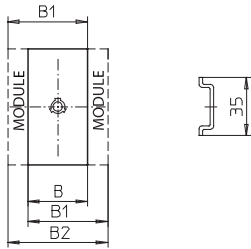
### Switching programmes 3 and 4 pole

Types H216 / H220 / H226 / H233:

Mtg. form	A1	A2	B	B1	B2	C	C1	C2	H
026V4	45	48	36	48	60	38	45	18.5	70
126V4	45	60	36	48	60	38	45	18.5	70

Types B240 / B250 / B263:

Mtg. form	A1	A2	B	B1	B2	C	C1	C2	H
026V4	45	52.5	50	69	88	38	45	18.5	72

Types H406 / H408 / H410 / H412:

Mtg. form	A1	A2	B	B1	B2	C	C1	C2	H
126V4	45	72	70	89	108	55	48	16	80

### Switching programmes 6 and 8 pole

Types H216 / H220 / H226 / H233:

Mtg. form	A1	A2	B	B1	B2	C	C1	C2	H
026V4	45	76	72	84	96	40	51.5	25.5	70

Types B240 / B250 / B263:

Mtg. form	A1	A2	B	B1	B2	C	C1	C2	H
026V4	45	105	100	119	138	40	51.5	25.5	72

Types H406 / H408 / H410 / H412:

Mtg. form	A1	A2	B	B1	B2	C	C1	C2	H
126V4	45	72	140	159	178	67	48	16	80

# Disconnect Switches

Main/Emergency-Off Switches **Base mounting** Snap-on mounting with door interlock

## Main/Emergency-Off Switches

- Base mounting switches with snap-on mounting
- Door interlock
- 3 up to 8 pole
- 20 A up to 125 A
- **IP66**
- with modular or metal shaft extension
- single or four hole front mounting



Base mounting switches with snap-on mounting and door interlock are offered with two different extensions:

1. Switches with **modular shaft extensions** can be extended with additional modules (modular shaft extensions see picture) which can be fixed to achieve different required mounting depths – dimension C. The modules are detailed on page 145.

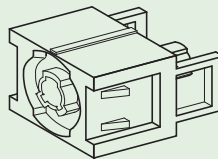
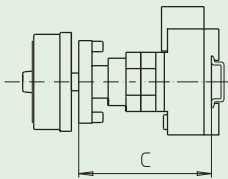

AVC2/AVC4  
Modular shaft extension

2. For switches with **metal shaft extension** the metal shaft is not included in the scope of delivery and has to be ordered separately. Data for mounting dimension C and for the different types of metal shafts can be found on page 146.

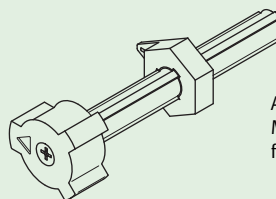
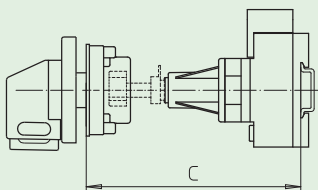

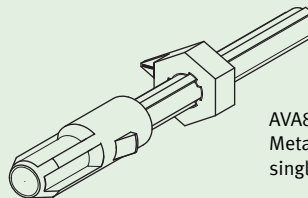
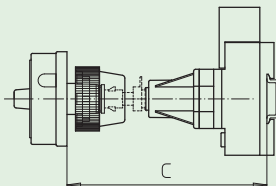

AVB8  
Metal shaft extension for  
four hole front mounting



AVA8  
Metal shaft extension for  
single hole front mounting

# Disconnect Switches

Main/Emergency-Off Switches **Base mounting** Snap-on mounting with door interlock

Switching programme	Rated data (IEC 60947)			Mounting dimension (front) (mm)	Padlock device N-handle yellow/red	Padlock device M-handle yellow/red	Padlockable handle V-handle yellow/red
	Operat. current $I_e$	Operational power (at 380–440 V)			 IP66	 IP66	 IP66
	AC-21A (A)	AC-23A (kW)	AC-3 (kW)		Order code number	Order code number	Order code number

**41300**  
– 3 pole  
– without auxiliary contacts



**Modular shaft extension:**

→ Modular shaft extensions see page 145!

20	25	32	40	50	63	80	100	125	36 × 36	48 × 48	36 × 36	48 × 48	36 × 36	48 × 48	36 × 36	48 × 48	36 × 36	48 × 48
20	5.5	3.7	36 × 36	H216-41300-234N4	H216-41300-234M4	H216-41300-234V4												
20	5.5	3.7	48 × 48	H216-41300-238N4	H216-41300-238M4	H216-41300-238V4												
25	7.5	5.5	36 × 36	H220-41300-234N4	H220-41300-234M4	H220-41300-234V4												
25	7.5	5.5	48 × 48	H220-41300-238N4	H220-41300-238M4	H220-41300-238V4												
32	11	7.5	36 × 36	H226-41300-234N4	H226-41300-234M4	H226-41300-234V4												
32	11	7.5	48 × 48	H226-41300-238N4	H226-41300-238M4	H226-41300-238V4												
40	15	11	36 × 36	H233-41300-234N4	H233-41300-234M4	H233-41300-234V4												
40	15	11	36 × 36	B240-41300-234N4*	B240-41300-234M4*	B240-41300-234V4*												
40	15	11	48 × 48	H233-41300-238N4	H233-41300-238M4	H233-41300-238V4												
40	15	11	48 × 48	B240-41300-238N4*	B240-41300-238M4*	B240-41300-238V4*												
50	18.5	15	36 × 36	B250-41300-234N4	B250-41300-234M4	B250-41300-234V4												
50	18.5	15	48 × 48	B250-41300-238N4	B250-41300-238M4	B250-41300-238V4												
63	22	18.5	36 × 36	B263-41300-234N4	B263-41300-234M4	B263-41300-234V4												
63	22	18.5	48 × 48	B263-41300-238N4	B263-41300-238M4	B263-41300-238V4												
63	22	18.5	48 × 48	H406-41300-234N4*	H406-41300-234M4*	H406-41300-234V4*												
80	30	22	48 × 48	H408-41300-234N4	H408-41300-234M4	H408-41300-234V4												
100	37	30	48 × 48	H410-41300-234N4	H410-41300-234M4	H410-41300-234V4												
125	45	37	48 × 48	H412-41300-234N4	H412-41300-234M4	H412-41300-234V4												



**Metal shaft extension:**

→ Metal shaft is not included. Please order separately, see page 146!

20	25	32	40	50	63	80	100	125	36 × 36	48 × 48	∅ 22.5	36 × 36	48 × 48	∅ 22.5	36 × 36	48 × 48	∅ 22.5	36 × 36	48 × 48	∅ 22.5
20	5.5	3.7	36 × 36	H216-41300-483N4	H216-41300-483M4	H216-41300-483V4														
20	5.5	3.7	48 × 48	H216-41300-484N4	H216-41300-484M4	H216-41300-484V4														
20	5.5	3.7	∅ 22.5	H216-41300-281N4	H216-41300-281M4	H216-41300-281V4														
25	7.5	5.5	36 × 36	H220-41300-483N4	H220-41300-483M4	H220-41300-483V4														
25	7.5	5.5	48 × 48	H220-41300-484N4	H220-41300-484M4	H220-41300-484V4														
25	7.5	5.5	∅ 22.5	H220-41300-281N4	H220-41300-281M4	H220-41300-281V4														
32	11	7.5	36 × 36	H226-41300-483N4	H226-41300-483M4	H226-41300-483V4														
32	11	7.5	48 × 48	H226-41300-484N4	H226-41300-484M4	H226-41300-484V4														
32	11	7.5	∅ 22.5	H226-41300-281N4	H226-41300-281M4	H226-41300-281V4														
40	15	11	36 × 36	H233-41300-483N4	H233-41300-483M4	H233-41300-483V4														
40	15	11	36 × 36	B240-41300-483N4*	B240-41300-483M4*	B240-41300-483V4*														
40	15	11	48 × 48	H233-41300-484N4	H233-41300-484M4	H233-41300-484V4														
40	15	11	48 × 48	B240-41300-484N4*	B240-41300-484M4*	B240-41300-484V4*														
40	15	11	∅ 22.5	H233-41300-281N4	H233-41300-281M4	H233-41300-281V4														
40	15	11	∅ 22.5	B240-41300-281N4*	B240-41300-281M4*	B240-41300-281V4*														
50	18.5	15	36 × 36	B250-41300-483N4	B250-41300-483M4	B250-41300-483V4														
50	18.5	15	48 × 48	B250-41300-484N4	B250-41300-484M4	B250-41300-484V4														
50	18.5	15	∅ 22.5	B250-41300-281N4	B250-41300-281M4	B250-41300-281V4														
63	22	18.5	36 × 36	B263-41300-483N4	B263-41300-483M4	B263-41300-483V4														
63	22	18.5	48 × 48	B263-41300-484N4	B263-41300-484M4	B263-41300-484V4														
63	22	18.5	48 × 48	H406-41300-483N4*	H406-41300-483M4*	H406-41300-483V4*														
63	22	18.5	∅ 22.5	B263-41300-281N4	B263-41300-281M4	B263-41300-281V4														
63	22	18.5	∅ 22.5	H406-41300-281N4*	H406-41300-281M4*	H406-41300-281V4*														
80	30	22	48 × 48	H408-41300-483N4	H408-41300-483M4	H408-41300-483V4														
80	30	22	∅ 22.5	H408-41300-281N4	H408-41300-281M4	H408-41300-281V4														
100	37	30	48 × 48	H410-41300-483N4	H410-41300-483M4	H410-41300-483V4														
100	37	30	∅ 22.5	H410-41300-281N4	H410-41300-281M4	H410-41300-281V4														
125	45	37	48 × 48	H412-41300-483N4	H412-41300-483M4	H412-41300-483V4														
125	45	37	∅ 22.5	H412-41300-281N4	H412-41300-281M4	H412-41300-281V4														

\* larger terminal capacity, see page 154

Further switching programmes from page 132.

Switching programme	Rated data (IEC 60947)			Mounting dimension (front) (mm)	Padlock device N-handle yellow/red	Padlock device M-handle yellow/red	Padlockable handle V-handle yellow/red
	Operat. current $I_e$	Operational power (at 380–440 V)			 IP66	 IP66	 IP66
	AC-21A (A)	AC-23A (kW)	AC-3 (kW)		Order code number	Order code number	Order code number

**41400**

- 4 pole
- without auxiliary contacts
- neutral contact
- early make/late break

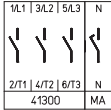

**Modular shaft extension:**

➔ Modular shaft extensions see page 145!

Height	Width	Depth	Mounting dimension	Order code number	Order code number	Order code number
20	5.5	3.7	36 x 36	H216-41400-234N4	H216-41400-234M4	H216-41400-234V4
20	5.5	3.7	48 x 48	H216-41400-238N4	H216-41400-238M4	H216-41400-238V4
25	7.5	5.5	36 x 36	H220-41400-234N4	H220-41400-234M4	H220-41400-234V4
25	7.5	5.5	48 x 48	H220-41400-238N4	H220-41400-238M4	H220-41400-238V4
32	11	7.5	36 x 36	H226-41400-234N4	H226-41400-234M4	H226-41400-234V4
32	11	7.5	48 x 48	H226-41400-238N4	H226-41400-238M4	H226-41400-238V4
40	15	11	36 x 36	H233-41400-234N4	H233-41400-234M4	H233-41400-234V4
40	15	11	36 x 36	B240-41400-234N4*	B240-41400-234M4*	B240-41400-234V4*
40	15	11	48 x 48	H233-41400-238N4	H233-41400-238M4	H233-41400-238V4
40	15	11	48 x 48	B240-41400-238N4*	B240-41400-238M4*	B240-41400-238V4*
50	18.5	15	36 x 36	B250-41400-234N4	B250-41400-234M4	B250-41400-234V4
50	18.5	15	48 x 48	B250-41400-238N4	B250-41400-238M4	B250-41400-238V4
63	22	18.5	36 x 36	B263-41400-234N4	B263-41400-234M4	B263-41400-234V4
63	22	18.5	48 x 48	B263-41400-238N4	B263-41400-238M4	B263-41400-238V4
63	22	18.5	48 x 48	H406-41400-234N4*	H406-41400-234M4*	H406-41400-234V4*
80	30	22	48 x 48	H408-41400-234N4	H408-41400-234M4	H408-41400-234V4
100	37	30	48 x 48	H410-41400-234N4	H410-41400-234M4	H410-41400-234V4
125	45	37	48 x 48	H412-41400-234N4	H412-41400-234M4	H412-41400-234V4

**Metal shaft extension:**

➔ Metal shaft is not included. Please order separately, see page 146!



Height	Width	Depth	Mounting dimension	Order code number	Order code number	Order code number
20	5.5	3.7	36 x 36	H216-41400-483N4	H216-41400-483M4	H216-41400-483V4
20	5.5	3.7	48 x 48	H216-41400-484N4	H216-41400-484M4	H216-41400-484V4
20	5.5	3.7	∅ 22.5	H216-41400-281N4	H216-41400-281M4	H216-41400-281V4
25	7.5	5.5	36 x 36	H220-41400-483N4	H220-41400-483M4	H220-41400-483V4
25	7.5	5.5	48 x 48	H220-41400-484N4	H220-41400-484M4	H220-41400-484V4
25	7.5	5.5	∅ 22.5	H220-41400-281N4	H220-41400-281M4	H220-41400-281V4
32	11	7.5	36 x 36	H226-41400-483N4	H226-41400-483M4	H226-41400-483V4
32	11	7.5	48 x 48	H226-41400-484N4	H226-41400-484M4	H226-41400-484V4
32	11	7.5	∅ 22.5	H226-41400-281N4	H226-41400-281M4	H226-41400-281V4
40	15	11	36 x 36	H233-41400-483N4	H233-41400-483M4	H233-41400-483V4
40	15	11	36 x 36	B240-41400-483N4*	B240-41400-483M4*	B240-41400-483V4*
40	15	11	48 x 48	H233-41400-484N4	H233-41400-484M4	H233-41400-484V4
40	15	11	48 x 48	B240-41400-484N4*	B240-41400-484M4*	B240-41400-484V4*
40	15	11	∅ 22.5	H233-41400-281N4	H233-41400-281M4	H233-41400-281V4
40	15	11	∅ 22.5	B240-41400-281N4*	B240-41400-281M4*	B240-41400-281V4*
50	18.5	15	36 x 36	B250-41400-483N4	B250-41400-483M4	B250-41400-483V4
50	18.5	15	48 x 48	B250-41400-484N4	B250-41400-484M4	B250-41400-484V4
50	18.5	15	∅ 22.5	B250-41400-281N4	B250-41400-281M4	B250-41400-281V4
63	22	18.5	36 x 36	B263-41400-483N4	B263-41400-483M4	B263-41400-483V4
63	22	18.5	48 x 48	B263-41400-484N4	B263-41400-484M4	B263-41400-484V4
63	22	18.5	48 x 48	H406-41400-483N4*	H406-41400-483M4*	H406-41400-483V4*
63	22	18.5	∅ 22.5	B263-41400-281N4	B263-41400-281M4	B263-41400-281V4
63	22	18.5	∅ 22.5	H406-41400-281N4*	H406-41400-281M4*	H406-41400-281V4*
80	30	22	48 x 48	H408-41400-483N4	H408-41400-483M4	H408-41400-483V4
80	30	22	∅ 22.5	H408-41400-281N4	H408-41400-281M4	H408-41400-281V4
100	37	30	48 x 48	H410-41400-483N4	H410-41400-483M4	H410-41400-483V4
100	37	30	∅ 22.5	H410-41400-281N4	H410-41400-281M4	H410-41400-281V4
125	45	37	48 x 48	H412-41400-483N4	H412-41400-483M4	H412-41400-483V4
125	45	37	∅ 22.5	H412-41400-281N4	H412-41400-281M4	H412-41400-281V4

\* larger terminal capacity, see page 154

Further switching programmes from page 132.

# Disconnect Switches

Main/Emergency-Off Switches **Base mounting** Snap-on mounting with door interlock

Switching programme	Rated data (IEC 60947)			Mounting dimension (front) (mm)	Padlock device N-handle yellow/red	Padlock device M-handle yellow/red	Padlockable handle V-handle yellow/red
	Operat. current $I_e$	Operational power (at 380–440 V)			 IP66	 IP66	 IP66
	AC-21A (A)	AC-23A (kW)	AC-3 (kW)		Order code number	Order code number	Order code number

**41600**  
– 6 pole  
– without auxiliary contacts

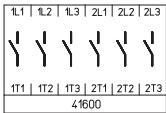

**Modular shaft extension:**

➔ Modular shaft extensions see page 145!

Height	Width	Depth	Mounting dimension	Order code number	Order code number	Order code number
20	5.5	3.7	36 x 36	H216-41600-234N4	H216-41600-234M4	–
20	5.5	3.7	48 x 48	H216-41600-238N4	H216-41600-238M4	H216-41600-238V4
25	7.5	5.5	36 x 36	H220-41600-234N4	H220-41600-234M4	–
25	7.5	5.5	48 x 48	H220-41600-238N4	H220-41600-238M4	H220-41600-238V4
32	11	7.5	36 x 36	H226-41600-234N4	H226-41600-234M4	–
32	11	7.5	48 x 48	H226-41600-238N4	H226-41600-238M4	H226-41600-238V4
40	15	11	36 x 36	H233-41600-234N4	H233-41600-234M4	–
40	15	11	36 x 36	B240-41600-234N4*	B240-41600-234M4*	–
40	15	11	48 x 48	H233-41600-238N4	H233-41600-238M4	H233-41600-238V4
40	15	11	48 x 48	B240-41600-238N4*	B240-41600-238M4*	B240-41600-238V4*
50	18.5	15	36 x 36	B250-41600-234N4	B250-41600-234M4	–
50	18.5	15	48 x 48	B250-41600-238N4	B250-41600-238M4	B250-41600-238V4
63	22	18.5	36 x 36	B263-41600-234N4	B263-41600-234M4	–
63	22	18.5	48 x 48	B263-41600-238N4	B263-41600-238M4	B263-41600-238V4
63	22	18.5	48 x 48	H406-41600-234N4*	H406-41600-234M4*	H406-41600-234V4*
80	30	22	48 x 48	H408-41600-234N4	H408-41600-234M4	H408-41600-234V4
100	37	30	48 x 48	H410-41600-234N4	H410-41600-234M4	H410-41600-234V4
125	45	37	48 x 48	H412-41600-234N4	H412-41600-234M4	H412-41600-234V4



**Metal shaft extension:**

➔ Metal shaft is not included. Please order separately, see page 146!

Height	Width	Depth	Mounting dimension	Order code number	Order code number	Order code number
20	5.5	3.7	36 x 36	H216-41600-483N4	H216-41600-483M4	–
20	5.5	3.7	48 x 48	H216-41600-484N4	H216-41600-484M4	H216-41600-484V4
20	5.5	3.7	∅ 22.5	H216-41600-281N4	H216-41600-281M4	–
25	7.5	5.5	36 x 36	H220-41600-483N4	H220-41600-483M4	–
25	7.5	5.5	48 x 48	H220-41600-484N4	H220-41600-484M4	H220-41600-484V4
25	7.5	5.5	∅ 22.5	H220-41600-281N4	H220-41600-281M4	–
32	11	7.5	36 x 36	H226-41600-483N4	H226-41600-483M4	–
32	11	7.5	48 x 48	H226-41600-484N4	H226-41600-484M4	H226-41600-484V4
32	11	7.5	∅ 22.5	H226-41600-281N4	H226-41600-281M4	–
40	15	11	36 x 36	H233-41600-483N4	H233-41600-483M4	–
40	15	11	36 x 36	B240-41600-483N4*	B240-41600-483M4*	–
40	15	11	48 x 48	H233-41600-484N4	H233-41600-484M4	H233-41600-484V4
40	15	11	48 x 48	B240-41600-484N4*	B240-41600-484M4*	B240-41600-484V4*
40	15	11	∅ 22.5	H233-41600-281N4	H233-41600-281M4	–
40	15	11	∅ 22.5	B240-41600-281N4*	B240-41600-281M4*	–
50	18.5	15	36 x 36	B250-41600-483N4	B250-41600-483M4	–
50	18.5	15	48 x 48	B250-41600-484N4	B250-41600-484M4	B250-41600-484V4
50	18.5	15	∅ 22.5	B250-41600-281N4	B250-41600-281M4	–
63	22	18.5	36 x 36	B263-41600-483N4	B263-41600-483M4	–
63	22	18.5	48 x 48	B263-41600-484N4	B263-41600-484M4	B263-41600-484V4
63	22	18.5	48 x 48	H406-41600-483N4*	H406-41600-483M4*	H406-41600-483V4*
63	22	18.5	∅ 22.5	B263-41600-281N4	B263-41600-281M4	–
63	22	18.5	∅ 22.5	H406-41600-281N4*	H406-41600-281M4*	H406-41600-281V4
80	30	22	48 x 48	H408-41600-483N4	H408-41600-483M4	H408-41600-483V4
80	30	22	∅ 22.5	H408-41600-281N4	H408-41600-281M4	H408-41600-281V4
100	37	30	48 x 48	H410-41600-483N4	H410-41600-483M4	H410-41600-483V4
100	37	30	∅ 22.5	H410-41600-281N4	H410-41600-281M4	H410-41600-281V4
125	45	37	48 x 48	H412-41600-483N4	H412-41600-483M4	H412-41600-483V4
125	45	37	∅ 22.5	H412-41600-281N4	H412-41600-281M4	H412-41600-281V4

\* larger terminal capacity, see page 154

Further switching programmes from page 132.

Switching programme	Rated data (IEC 60947)			Mounting dimension (front) (mm)	Padlock device N-handle yellow/red	Padlock device M-handle yellow/red	Padlockable handle V-handle yellow/red
	Operat. current $I_e$	Operational power (at 380–440 V)					
	AC-21A (A)	AC-23A (kW)	AC-3 (kW)		IP66	IP66	IP66
					<b>Order code number</b>	<b>Order code number</b>	<b>Order code number</b>

- 41800**  
 – 8 pole  
 – without auxiliary contacts  
 – 2 neutral contacts  
 – early make/late break

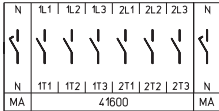

**Modular shaft extension:**

➔ Modular shaft extensions see page 145!

20	5.5	3.7	36 x 36	H216-41800-234N4	H216-41800-234M4	–
20	5.5	3.7	48 x 48	H216-41800-238N4	H216-41800-238M4	H216-41800-238V4
25	7.5	5.5	36 x 36	H220-41800-234N4	H220-41800-234M4	–
25	7.5	5.5	48 x 48	H220-41800-238N4	H220-41800-238M4	H220-41800-238V4
32	11	7.5	36 x 36	H226-41800-234N4	H226-41800-234M4	–
32	11	7.5	48 x 48	H226-41800-238N4	H226-41800-238M4	H226-41800-238V4
40	15	11	36 x 36	H233-41800-234N4	H233-41800-234M4	–
40	15	11	36 x 36	B240-41800-234N4*	B240-41800-234M4*	–
40	15	11	48 x 48	H233-41800-238N4	H233-41800-238M4	H233-41800-238V4
40	15	11	48 x 48	B240-41800-238N4*	B240-41800-238M4*	B240-41800-238V4*
50	18.5	15	36 x 36	B250-41800-234N4	B250-41800-234M4	–
50	18.5	15	48 x 48	B250-41800-238N4	B250-41800-238M4	B250-41800-238V4
63	22	18.5	36 x 36	B263-41800-234N4	B263-41800-234M4	–
63	22	18.5	48 x 48	B263-41800-238N4	B263-41800-238M4	B263-41800-238V4
63	22	18.5	48 x 48	H406-41800-234N4*	H406-41800-234M4*	H406-41800-234V4*
80	30	22	48 x 48	H408-41800-234N4	H408-41800-234M4	H408-41800-234V4
100	37	30	48 x 48	H410-41800-234N4	H410-41800-234M4	H410-41800-234V4
125	45	37	48 x 48	H412-41800-234N4	H412-41800-234M4	H412-41800-234V4

**Metal shaft extension:**

➔ Metal shaft is not included. Please order separately, see page 146!

20	5.5	3.7	36 x 36	H216-41800-483N4	H216-41800-483M4	–
20	5.5	3.7	48 x 48	H216-41800-484N4	H216-41800-484M4	H216-41800-484V4
20	5.5	3.7	∅ 22.5	H216-41800-281N4	H216-41800-281M4	–
25	7.5	5.5	36 x 36	H220-41800-483N4	H220-41800-483M4	–
25	7.5	5.5	48 x 48	H220-41800-484N4	H220-41800-484M4	H220-41800-484V4
25	7.5	5.5	∅ 22.5	H220-41800-281N4	H220-41800-281M4	–
32	11	7.5	36 x 36	H226-41800-483N4	H226-41800-483M4	–
32	11	7.5	48 x 48	H226-41800-484N4	H226-41800-484M4	H226-41800-484V4
32	11	7.5	∅ 22.5	H226-41800-281N4	H226-41800-281M4	–
40	15	11	36 x 36	H233-41800-483N4	H233-41800-483M4	–
40	15	11	36 x 36	B240-41800-483N4*	B240-41800-483M4*	–
40	15	11	48 x 48	H233-41800-484N4	H233-41800-484M4	H233-41800-484V4
40	15	11	48 x 48	B240-41800-484N4*	B240-41800-484M4*	B240-41800-484V4*
40	15	11	∅ 22.5	H233-41800-281N4	H233-41800-281M4	–
40	15	11	∅ 22.5	B240-41800-281N4*	B240-41800-281M4*	–
50	18.5	15	36 x 36	B250-41800-483N4	B250-41800-483M4	–
50	18.5	15	48 x 48	B250-41800-484N4	B250-41800-484M4	B250-41800-484V4
50	18.5	15	∅ 22.5	B250-41800-281N4	B250-41800-281M4	–
63	22	18.5	36 x 36	B263-41800-483N4	B263-41800-483M4	–
63	22	18.5	48 x 48	B263-41800-484N4	B263-41800-484M4	B263-41800-484V4
63	22	18.5	48 x 48	H406-41800-483N4*	H406-41800-483M4*	H406-41800-483V4*
63	22	18.5	∅ 22.5	B263-41800-281N4	B263-41800-281M4	–
63	22	18.5	∅ 22.5	H406-41800-281N4*	H406-41800-281M4*	H406-41800-281V4
80	30	22	48 x 48	H408-41800-483N4	H408-41800-483M4	H408-41800-483V4
80	30	22	∅ 22.5	H408-41800-281N4	H408-41800-281M4	H408-41800-281V4
100	37	30	48 x 48	H410-41800-483N4	H410-41800-483M4	H410-41800-483V4
100	37	30	∅ 22.5	H410-41800-281N4	H410-41800-281M4	H410-41800-281V4
125	45	37	48 x 48	H412-41800-483N4	H412-41800-483M4	H412-41800-483V4
125	45	37	∅ 22.5	H412-41800-281N4	H412-41800-281M4	H412-41800-281V4

\* larger terminal capacity, see page 154

Further switching programmes from page 132.

# Disconnect Switches

Main/Emergency-Off Switches **Base mounting** Snap-on mounting with door interlock

Dimensions in mm:

Door interlock with **modular shaft extension**: Four hole front mounting

Setup of order code number		
Type	Switching progr.	Mtg. form
H233	41400	234N4
Order code no. <b>H233-41400-234N4</b>		

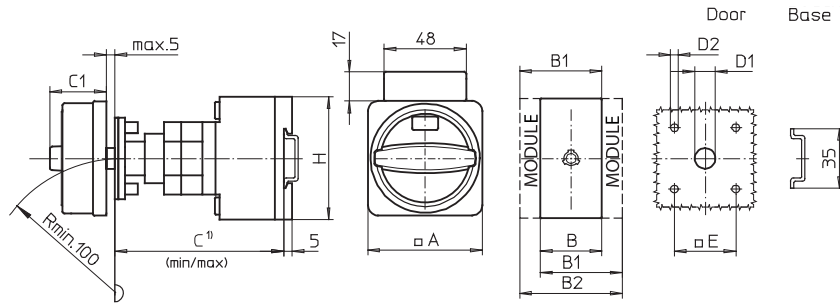

<sup>1)</sup> Internal depth: inside of door to top of DIN rail, dimensions with shaft extension see page 145.

### Switching programmes 3 and 4 pole

Types H216 / H220 / H226 / H233:

Mtg. form	A	B	B1	B2	C <sub>min</sub>	C <sub>max</sub>	C1	D1	D2	E	H
234M4	67	36	48	60	92	107	38	15	4.5	36	70
234N4	67	36	48	60	92	107	33	15	4.5	36	70
234V4	48	36	48	60	92	107	32	12	4.5	36	70
238M4	67	36	48	60	92	107	38	15	5	48	70
238N4	67	36	48	60	92	107	33	15	5	48	70
238V4	64	36	48	60	92	107	39	15	5	48	70

### Switching programmes 6 and 8 pole

Types H216 / H220 / H226 / H233:

Mtg. form	A	B	B1	B2	C <sub>min</sub>	C <sub>max</sub>	C1	D1	D2	E	H
234M4	67	72	84	96	100	115	38	15	4.5	36	70
234N4	67	72	84	96	100	115	33	15	4.5	36	70
238M4	67	72	84	96	100	115	38	15	5	48	70
238N4	67	72	84	96	100	115	33	15	5	48	70
238V4	64	72	84	96	100	115	39	15	5	48	70

Types B240 / B250 / B263:

Mtg. form	A	B	B1	B2	C <sub>min</sub>	C <sub>max</sub>	C1	D1	D2	E	H
234M4	67	50	69	88	92	107	38	15	4.5	36	72
234N4	67	50	69	88	92	107	33	15	4.5	36	72
234V4	48	50	69	88	92	107	32	12	4.5	36	72
238M4	67	50	69	88	92	107	38	15	5	48	72
238N4	67	50	69	88	92	107	33	15	5	48	72
238V4	64	50	69	88	92	107	39	15	5	48	72

Types B240 / B250 / B263:

Mtg. form	A	B	B1	B2	C <sub>min</sub>	C <sub>max</sub>	C1	D1	D2	E	H
234M4	67	100	119	138	104	119	38	15	4.5	36	72
234N4	67	100	119	138	104	119	33	15	4.5	36	72
238M4	67	100	119	138	104	119	38	15	5	48	72
238N4	67	100	119	138	104	119	33	15	5	48	72
238V4	64	100	119	138	104	119	39	15	5	48	72

Types H406 / H408 / H410 / H412:

Mtg. form	A	B	B1	B2	C <sub>min</sub>	C <sub>max</sub>	C1	D1	D2	E	H
234M4	88	70	89	108	102	117	50	15	5	48	80
234N4	88	70	89	108	102	117	45	15	5	48	80
234V4	64	70	89	108	102	117	40	15	5	48	80

Types H406 / H408 / H410 / H412:

Mtg. form	A	B	B1	B2	C <sub>min</sub>	C <sub>max</sub>	C1	D1	D2	E	H
234M4	88	140	159	178	115	130	50	15	5	48	80
234N4	88	140	159	178	115	130	45	15	5	48	80
234V4	64	140	159	178	115	130	40	15	5	48	80

# Disconnect Switches



Main/Emergency-Off Switches **Base mounting** Snap-on mounting with door interlock

Dimensions in mm:

Door interlock with **metal shaft extension**: Four hole front mounting

Setup of order code number		
Type	Switching progr.	Mtg. form
H406	41800	483N4
Order code no. <b>H406-41800-483N4</b>		

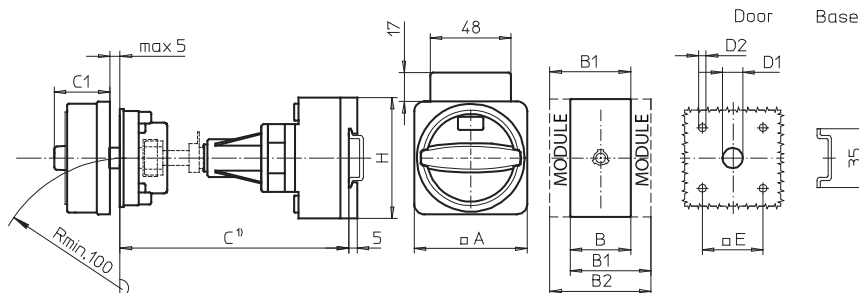

<sup>1)</sup> Internal depth: inside of door to top of DIN rail, dimensions see page 146.

### Switching programmes 3 and 4 pole

Types H216 / H220 / H226 / H233:

Mtg. form	A	B	B1	B2	C1	D1	D2	E	H
483M4	67	36	48	60	38	15	4.5	36	70
483N4	67	36	48	60	33	15	4.5	36	70
483V4	48	36	48	60	32	15	4.5	36	70
484M4	67	36	48	60	38	15	5	48	70
484N4	67	36	48	60	33	15	5	48	70
484V4	64	36	48	60	39	15	5	48	70

Types B240 / B250 / B263:

Mtg. form	A	B	B1	B2	C1	D1	D2	E	H
483M4	67	50	69	88	38	15	4.5	36	72
483N4	67	50	69	88	33	15	4.5	36	72
483V4	48	50	69	88	32	15	4.5	36	72
484M4	67	50	69	88	38	15	5	48	72
484N4	67	50	69	88	33	15	5	48	72
484V4	64	50	69	88	39	15	5	48	72

Types H406 / H408 / H410 / H412:

Mtg. form	A	B	B1	B2	C1	D1	D2	E	H
483M4	88	70	89	108	50	15	5	48	80
483N4	88	70	89	108	45	15	5	48	80
483V4	64	70	89	108	40	15	5	48	80

### Switching programmes 6 and 8 pole

Types H216 / H220 / H226 / H233:

Mtg. form	A	B	B1	B2	C1	D1	D2	E	H
483M4	67	72	84	96	38	15	4.5	36	70
483N4	67	72	84	96	33	15	4.5	36	70
484M4	67	72	84	96	38	15	5	48	70
484N4	67	72	84	96	33	15	5	48	70
484V4	64	72	84	96	39	15	5	48	70

Types B240 / B250 / B263:

Mtg. form	A	B	B1	B2	C1	D1	D2	E	H
483M4	67	100	119	138	38	15	4.5	36	72
483N4	67	100	119	138	33	15	4.5	36	72
484M4	67	100	119	138	38	15	5	48	72
484N4	67	100	119	138	33	15	5	48	72
484V4	64	100	119	138	39	15	5	48	72

Types H406 / H408 / H410 / H412:

Mtg. form	A	B	B1	B2	C1	D1	D2	E	H
483M4	88	140	159	178	50	15	5	48	80
483N4	88	140	159	178	45	15	5	48	80
483V4	64	140	159	178	40	15	5	48	80



# Disconnect Switches

Main/Emergency-Off Switches **Base mounting** Snap-on mounting with door interlock

Dimensions in mm:

Door interlock with **metal shaft extension**: Single hole front mounting

Setup of order code number		
Type	Switching progr.	Mtg. form
H233	41400	281N4
Order code no. <b>H233-41400-281N4</b>		

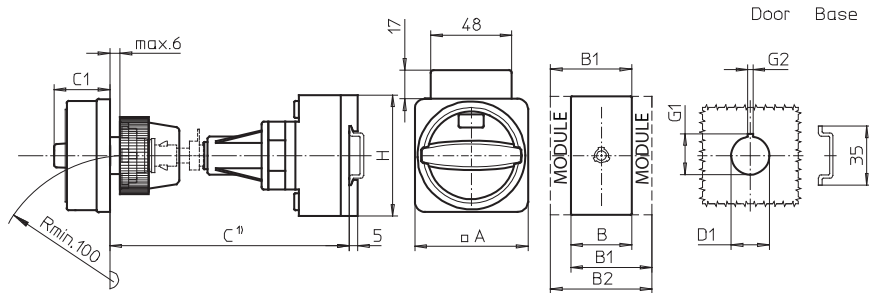

<sup>1)</sup> Internal depth: outside of door to top of DIN rail, dimensions see page 146.

### Switching programmes 3 and 4 pole

Types H216 / H220 / H226 / H233:

Mtg. form	A	B	B1	B2	C1	D1	G1	G2	H
281M4	67	36	48	60	38	22.5	24.2	3.2	70
281N4	67	36	48	60	33	22.5	24.2	3.2	70
281V4	48	36	48	60	32	22.5	24.2	3.2	70

Types B240 / B250 / B263:

Mtg. form	A	B	B1	B2	C1	D1	G1	G2	H
281M4	67	50	69	88	38	22.5	24.2	3.2	72
281N4	67	50	69	88	33	22.5	24.2	3.2	72
281V4	48	50	69	88	32	22.5	24.2	3.2	72

Types H406 / H408 / H410 / H412:

Mtg. form	A	B	B1	B2	C1	D1	G1	G2	H
281M4	67	70	89	108	38	22.5	24.2	3.2	80
281N4	67	70	89	108	33	22.5	24.2	3.2	80
281V4	64	70	89	108	39	22.5	24.2	3.2	80

### Switching programmes 6 and 8 pole

Types H216 / H220 / H226 / H233:

Mtg. form	A	B	B1	B2	C1	D1	G1	G2	H
281M4	67	72	84	96	38	22.5	24.2	3.2	70
281N4	67	72	84	96	33	22.5	24.2	3.2	70

Types B240 / B250 / B263:

Mtg. form	A	B	B1	B2	C1	D1	G1	G2	H
281M4	67	100	119	138	38	22.5	24.2	3.2	72
281N4	67	100	119	138	33	22.5	24.2	3.2	72



Types H406 / H408 / H410 / H412:

Mtg. form	A	B	B1	B2	C1	D1	G1	G2	H
281M4	67	140	159	178	38	22.5	24.2	3.2	80
281N4	67	140	159	178	33	22.5	24.2	3.2	80
281V4	64	140	159	178	39	22.5	24.2	3.2	80

## Main/Emergency-Off Switches

- Base mounting switches with four hole mounting
- Door interlock
- 3 up to 8 pole
- 160 A up to 315 A
- IP55



Switching programme	Rated data (IEC 60947)			Mounting dimension (base/front)  (mm)	Padlock device N-handle yellow/red	Padlock device M-handle yellow/red	Padlock device H-handle yellow/red
	Operat. current $I_e$	Operational power (at 380–440 V)			 OFF-ON IP55	 OFF-ON IP55	 OFF-ON IP55
	AC-21A (A)	AC-23A (kW)	AC-3 (kW)		Order code number	Order code number	Order code number
<b>41300</b> – 3 pole – without auxiliary contacts	160	75	45	68 × 68 / 68 × 68	<b>K616-41300-034N4</b>	<b>K616-41300-034M4</b>	<b>K616-41300-034H4</b>
	315	132	55	104 × 104 / 104 × 104	–	–	<b>K830-41300-034H4</b>



<b>41400</b> – 4 pole – without auxiliary contacts – neutral contact early make/late break	160	75	45	68 × 68 / 68 × 68	<b>K616-41400-034N4</b>	<b>K616-41400-034M4</b>	<b>K616-41400-034H4</b>
	315	132	55	104 × 104 / 104 × 104	–	–	<b>K830-41400-034H4</b>

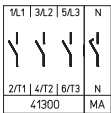

<b>41600</b> – 6 pole – without auxiliary contacts	160	75	45	68 × 68 / 68 × 68	<b>K616-41600-034N4</b>	<b>K616-41600-034M4</b>	<b>K616-41600-034H4</b>
	315	132	55	104 × 104 / 104 × 104	–	–	<b>K830-41600-034H4</b>

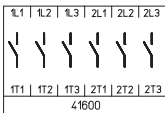

<b>41800</b> – 8 pole – without auxiliary contacts – 2 neutral contacts early make/late break	160	75	45	68 × 68 / 68 × 68	<b>K616-41800-034N4</b>	<b>K616-41800-034M4</b>	<b>K616-41800-034H4</b>
	315	132	55	104 × 104 / 104 × 104	–	–	<b>K830-41800-034H4</b>

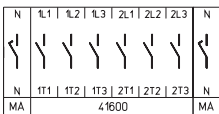

# Disconnect Switches

Main/Emergency-Off Switches **Base mounting** Four hole mounting with door interlock

Dimensions in mm:

Setup of order code number		
Type	Switching progr.	Mtg. form
K616	41300	034N4
Order code no.	<b>K616-41300-034N4</b>	

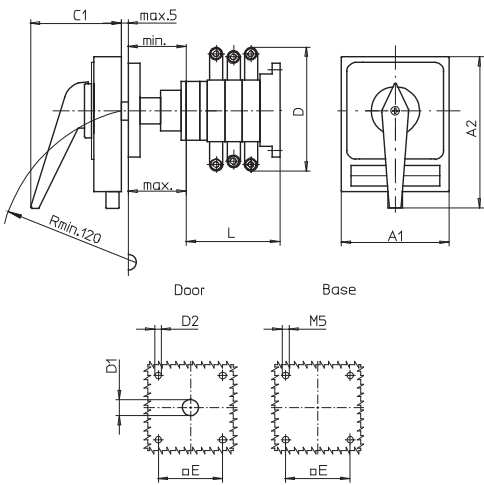
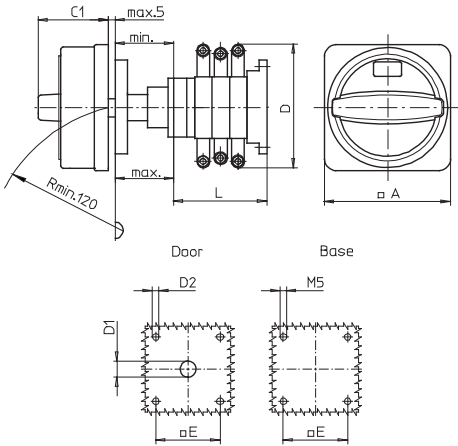

Type K616:

Mtg. form	Switching progr.	A	C1	D*	D1	D2	E	min	max	L
034M4	41300	88	50	150	15	5.5	68	48	60	104
034M4	41400	88	50	150	15	5.5	68	48	60	104
034M4	41600	88	50	150	15	5.5	68	48	60	136
034M4	41800	88	50	150	15	5.5	68	48	60	168
034N4	41300	88	45	150	15	5.5	68	48	60	104
034N4	41400	88	45	150	15	5.5	68	48	60	104
034N4	41600	88	45	150	15	5.5	68	48	60	136
034N4	41800	88	45	150	15	5.5	68	48	60	168

Type K616:

Mtg. form	Switching progr.	A1	A2	C1	D*	D1	D2	E	min	max	L
034H4	41300	98	142	83	150	15	5.5	68	48	60	104
034H4	41400	98	142	83	150	15	5.5	68	48	60	104
034H4	41600	98	142	83	150	15	5.5	68	48	60	136
034H4	41800	98	142	83	150	15	5.5	68	48	60	168

Type K830:

Mtg. form	Switching progr.	A1	A2	C1	D*	D1	D2	E	min	max	L
034H4	41300	130	176	93	210	20	5.5	104	75	102	125
034H4	41400	130	176	93	210	20	5.5	104	75	102	125
034H4	41600	130	176	93	210	20	5.5	104	75	102	161
034H4	41800	130	176	93	210	20	5.5	104	75	102	197

\* terminal lugs included

Further switching programmes and corresponding dimensions for types K on request.

## Main/Emergency-Off Switches

- Enclosed switches with insulated enclosure (polycarbonate)
- Cover interlock in ON position
- 3 up to 8 pole
- 20 A up to 315 A
- IP66



Switching programme	Rated data (IEC 60947)			Enclosure dimension (H × W × D) (mm)	Padlock device N-handle yellow/red	Padlock device M-handle yellow/red	Padlockable handle V-handle yellow/red
	Operat. current I <sub>e</sub> (A)	Operational power (at 380–440 V) (kW)			 IP66	 IP66	 IP66
	AC-21A (A)	AC-23A (kW)	AC-3 (kW)		Order code number	Order code number	Order code number
<b>41300</b> – 3 pole – without auxiliary contacts  	20	5.5	3.7	125 × 100 × 85	<b>H216-41300-700N4</b>	<b>H216-41300-700M4</b>	<b>H216-41300-700V4</b>
	20	5.5	3.7	175 × 115 × 100	<b>H216-41300-710N4</b>	<b>H216-41300-710M4</b>	<b>H216-41300-710V4</b>
	20	5.5	3.7	250 × 160 × 120	<b>H216-41300-730N4</b>	<b>H216-41300-730M4</b>	<b>H216-41300-730V4</b>
	25	7.5	5.5	125 × 100 × 85	<b>H220-41300-700N4</b>	<b>H220-41300-700M4</b>	<b>H220-41300-700V4</b>
	25	7.5	5.5	175 × 115 × 100	<b>H220-41300-710N4</b>	<b>H220-41300-710M4</b>	<b>H220-41300-710V4</b>
	25	7.5	5.5	250 × 160 × 120	<b>H220-41300-730N4</b>	<b>H220-41300-730M4</b>	<b>H220-41300-730V4</b>
	32	11	7.5	125 × 100 × 85	<b>H226-41300-700N4</b>	<b>H226-41300-700M4</b>	<b>H226-41300-700V4</b>
	32	11	7.5	175 × 115 × 100	<b>H226-41300-710N4</b>	<b>H226-41300-710M4</b>	<b>H226-41300-710V4</b>
	32	11	7.5	250 × 160 × 120	<b>H226-41300-730N4</b>	<b>H226-41300-730M4</b>	<b>H226-41300-730V4</b>
	40	15	11	175 × 115 × 100	<b>H233-41300-710N4</b>	<b>H233-41300-710M4</b>	<b>H233-41300-710V4</b>
	40	15	11	175 × 115 × 100	<b>B240-41300-710N4*<sup>1</sup></b>	<b>B240-41300-710M4*<sup>1</sup></b>	<b>B240-41300-710V4*<sup>1</sup></b>
	40	15	11	250 × 160 × 120	<b>H233-41300-730N4</b>	<b>H233-41300-730M4</b>	<b>H233-41300-730V4</b>
	40	15	11	250 × 160 × 120	<b>B240-41300-730N4*</b>	<b>B240-41300-730M4*</b>	<b>B240-41300-730V4*</b>
	50	18.5	15	175 × 115 × 100	<b>B250-41300-710N4<sup>1</sup></b>	<b>B250-41300-710M4<sup>1</sup></b>	<b>B250-41300-710V4<sup>1</sup></b>
	50	18.5	15	250 × 160 × 120	<b>B250-41300-730N4</b>	<b>B250-41300-730M4</b>	<b>B250-41300-730V4</b>
	63	22	18.5	175 × 115 × 100	<b>B263-41300-710N4<sup>1</sup></b>	<b>B263-41300-710M4<sup>1</sup></b>	<b>B263-41300-710V4<sup>1</sup></b>
	63	22	18.5	250 × 160 × 120	<b>B263-41300-730N4</b>	<b>B263-41300-730M4</b>	<b>B263-41300-730V4</b>
	63	22	18.5	250 × 160 × 120	<b>H406-41300-730N4*</b>	<b>H406-41300-730M4*</b>	–
	63	22	18.5	280 × 190 × 130	<b>H406-41300-770N4</b>	<b>H406-41300-770M4</b>	<b>H406-41300-770V4</b>
	63	22	18.5	320 × 220 × 180	<b>H406-41300-477N4</b>	<b>H406-41300-477M4</b>	–
	80	30	22	250 × 160 × 120	<b>H408-41300-730N4</b>	<b>H408-41300-730M4</b>	–
	80	30	22	280 × 190 × 130	<b>H408-41300-770N4</b>	<b>H408-41300-770M4</b>	<b>H408-41300-770V4</b>
	80	30	22	320 × 220 × 180	<b>H408-41300-477N4</b>	<b>H408-41300-477M4</b>	–
	100	37	30	250 × 160 × 120	<b>H410-41300-730N4</b>	<b>H410-41300-730M4</b>	–
	100	37	30	280 × 190 × 130	<b>H410-41300-770N4</b>	<b>H410-41300-770M4</b>	<b>H410-41300-770V4</b>
	100	37	30	320 × 220 × 180	<b>H410-41300-477N4</b>	<b>H410-41300-477M4</b>	–
	125	45	37	320 × 220 × 180	<b>H412-41300-477N4</b>	<b>H412-41300-477M4</b>	–

\* larger terminal capacity, see page 154

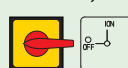

<sup>1</sup> Terminal capacity max. 16 mm<sup>2</sup> on N-terminal and/or PE-terminal

Further switching programmes as of page 132.

Rated data (IEC 60947)			Enclosure dimension (H × W × D) (mm)	Padlock device H-handle yellow/red
Operat. current I <sub>e</sub> (A)	Operational power (at 380–440 V) (kW)			 IP66
AC-21A (A)	AC-23A (kW)	AC-3 (kW)		Order code number
160	75	45	440 × 320 × 180	<b>K616-41300-077H4</b>
160	75	45	440 × 320 × 255	<b>K616-41300-177H4</b>
315	132	55	640 × 320 × 255	<b>K830-41300-077H4</b>
315	132	55	640 × 320 × 330	<b>K830-41300-177H4</b>

# Disconnect Switches

## Main/Emergency-Off Switches Enclosed Switches – Insulated Enclosure

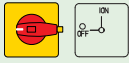
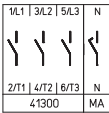
Switching programme	Rated data (IEC 60947)			Enclosure dimension (H × W × D) (mm)	Padlock device N-handle yellow/red	Padlock device M-handle yellow/red	Padlockable handle V-handle yellow/red
	Operat. current I <sub>e</sub> (A)	Operational power (at 380–440 V) (kW)			 IP66	 IP66	 IP66
		AC-21A	AC-23A		AC-3	Order code number	Order code number
<b>41400</b> – 4 pole – without auxiliary contacts – neutral contact – early make/late break  	20	5.5	3.7	125 × 100 × 85	<b>H216-41400-700N4</b>	<b>H216-41400-700M4</b>	<b>H216-41400-700V4</b>
	20	5.5	3.7	175 × 115 × 100	<b>H216-41400-710N4</b>	<b>H216-41400-710M4</b>	<b>H216-41400-710V4</b>
	20	5.5	3.7	250 × 160 × 120	<b>H216-41400-730N4</b>	<b>H216-41400-730M4</b>	<b>H216-41400-730V4</b>
	25	7.5	5.5	125 × 100 × 85	<b>H220-41400-700N4</b>	<b>H220-41400-700M4</b>	<b>H220-41400-700V4</b>
	25	7.5	5.5	175 × 115 × 100	<b>H220-41400-710N4</b>	<b>H220-41400-710M4</b>	<b>H220-41400-710V4</b>
	25	7.5	5.5	250 × 160 × 120	<b>H220-41400-730N4</b>	<b>H220-41400-730M4</b>	<b>H220-41400-730V4</b>
	32	11	7.5	125 × 100 × 85	<b>H226-41400-700N4</b>	<b>H226-41400-700M4</b>	<b>H226-41400-700V4</b>
	32	11	7.5	175 × 115 × 100	<b>H226-41400-710N4</b>	<b>H226-41400-710M4</b>	<b>H226-41400-710V4</b>
	32	11	7.5	250 × 160 × 120	<b>H226-41400-730N4</b>	<b>H226-41400-730M4</b>	<b>H226-41400-730V4</b>
	40	15	11	175 × 115 × 100	<b>H233-41400-710N4</b>	<b>H233-41400-710M4</b>	<b>H233-41400-710V4</b>
	40	15	11	175 × 115 × 100	<b>B240-41400-710N4*<sup>1</sup></b>	<b>B240-41400-710M4*<sup>1</sup></b>	<b>B240-41400-710V4*<sup>1</sup></b>
	40	15	11	250 × 160 × 120	<b>H233-41400-730N4</b>	<b>H233-41400-730M4</b>	<b>H233-41400-730V4</b>
	40	15	11	250 × 160 × 120	<b>B240-41400-730N4*</b>	<b>B240-41400-730M4*</b>	<b>B240-41400-730V4*</b>
	50	18.5	15	175 × 115 × 100	<b>B250-41400-710N4<sup>1</sup></b>	<b>B250-41400-710M4<sup>1</sup></b>	<b>B250-41400-710V4<sup>1</sup></b>
	50	18.5	15	250 × 160 × 120	<b>B250-41400-730N4</b>	<b>B250-41400-730M4</b>	<b>B250-41400-730V4</b>
	63	22	18.5	175 × 115 × 100	<b>B263-41400-710N4<sup>1</sup></b>	<b>B263-41400-710M4<sup>1</sup></b>	<b>B263-41400-710V4<sup>1</sup></b>
	63	22	18.5	250 × 160 × 120	<b>B263-41400-730N4</b>	<b>B263-41400-730M4</b>	<b>B263-41400-730V4</b>
	63	22	18.5	250 × 160 × 120	<b>H406-41400-730N4*</b>	<b>H406-41400-730M4*</b>	–
	63	22	18.5	280 × 190 × 130	<b>H406-41400-770N4</b>	<b>H406-41400-770M4</b>	<b>H406-41400-770V4</b>
	63	22	18.5	320 × 220 × 180	<b>H406-41400-477N4</b>	<b>H406-41400-477M4</b>	–
80	30	22	250 × 160 × 120	<b>H408-41400-730N4</b>	<b>H408-41400-730M4</b>	–	
80	30	22	280 × 190 × 130	<b>H408-41400-770N4</b>	<b>H408-41400-770M4</b>	<b>H408-41400-770V4</b>	
80	30	22	320 × 220 × 180	<b>H408-41400-477N4</b>	<b>H408-41400-477M4</b>	–	
100	37	30	250 × 160 × 120	<b>H410-41400-730N4</b>	<b>H410-41400-730M4</b>	–	
100	37	30	280 × 190 × 130	<b>H410-41400-770N4</b>	<b>H410-41400-770M4</b>	<b>H410-41400-770V4</b>	
100	37	30	320 × 220 × 180	<b>H410-41400-477N4</b>	<b>H410-41400-477M4</b>	–	
125	45	37	320 × 220 × 180	<b>H412-41400-477N4</b>	<b>H412-41400-477M4</b>	–	

Rated data (IEC 60947)			Enclosure dimension (H × W × D) (mm)	Padlock device H-handle yellow/red
Operat. current I <sub>e</sub> (A)	Operational power (at 380–440 V) (kW)			 IP66
	AC-21A	AC-23A	AC-3	Order code number
160	75	45	440 × 320 × 180	<b>K616-41400-077H4</b>
160	75	45	440 × 320 × 255	<b>K616-41400-177H4</b>
315	132	55	640 × 320 × 255	<b>K830-41400-077H4</b>
315	132	55	640 × 320 × 330	<b>K830-41400-177H4</b>

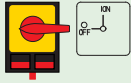
\* larger terminal capacity, see page 154

<sup>1</sup> Terminal capacity max. 16 mm<sup>2</sup> on N-terminal and/or PE-terminal

Further switching programmes from page 132.

# Disconnect Switches

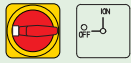
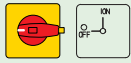
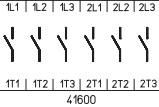

## Main/Emergency-Off Switches Enclosed Switches – Insulated Enclosure

Switching programme	Rated data (IEC 60947)			Enclosure dimension (H × W × D) (mm)	Padlock device N-handle yellow/red	Padlock device M-handle yellow/red	Padlockable handle V-handle yellow/red
	Operat. current $I_e$ (A)	Operational power (at 380–440 V) AC-23A (kW)	AC-3 (kW)				
					IP66	IP66	IP66
				Order code number	Order code number	Order code number	
<b>41600</b> – 6 pole – without auxiliary contacts 	20	5.5	3.7	175 × 115 × 100	<b>H216-41600-720N4</b>	<b>H216-41600-720M4</b>	<b>H216-41600-720V4</b>
	20	5.5	3.7	250 × 160 × 120	<b>H216-41600-733N4</b>	<b>H216-41600-733M4</b>	<b>H216-41600-733V4</b>
	25	7.5	5.5	175 × 115 × 100	<b>H220-41600-720N4</b>	<b>H220-41600-720M4</b>	<b>H220-41600-720V4</b>
	25	7.5	5.5	250 × 160 × 120	<b>H220-41600-733N4</b>	<b>H220-41600-733M4</b>	<b>H220-41600-733V4</b>
	32	11	7.5	175 × 115 × 100	<b>H226-41600-720N4</b>	<b>H226-41600-720M4</b>	<b>H226-41600-720V4</b>
	32	11	7.5	250 × 160 × 120	<b>H226-41600-733N4</b>	<b>H226-41600-733M4</b>	<b>H226-41600-733V4</b>
	40	15	11	175 × 115 × 100	<b>H233-41600-720N4</b>	<b>H233-41600-720M4</b>	<b>H233-41600-720V4</b>
	40	15	11	250 × 160 × 120	<b>H233-41600-733N4</b>	<b>H233-41600-733M4</b>	<b>H233-41600-733V4</b>
	40	15	11	320 × 220 × 180	<b>B240-41600-977N4</b>	<b>B240-41600-977M4</b>	–
	50	18.5	15	320 × 220 × 180	<b>B250-41600-977N4</b>	<b>B250-41600-977M4</b>	–
	63	22	18.5	320 × 220 × 180	<b>B263-41600-977N4</b>	<b>B263-41600-977M4</b>	–
	63	22	18.5	320 × 220 × 180	<b>H406-41600-977N4*</b>	<b>H406-41600-977M4*</b>	–
	63	22	18.5	440 × 320 × 180	<b>H406-41600-577N4</b>	<b>H406-41600-577M4</b>	–
	80	30	22	320 × 220 × 180	<b>H408-41600-977N4</b>	<b>H408-41600-977M4</b>	–
	80	30	22	440 × 320 × 180	<b>H408-41600-577N4</b>	<b>H408-41600-577M4</b>	–
	100	37	30	320 × 220 × 180	<b>H410-41600-977N4</b>	<b>H410-41600-977M4</b>	–
	100	37	30	440 × 320 × 180	<b>H410-41600-577N4</b>	<b>H410-41600-577M4</b>	–
	125	45	37	320 × 220 × 180	<b>H412-41600-977N4</b>	<b>H412-41600-977M4</b>	–
125	45	37	440 × 320 × 180	<b>H412-41600-577N4</b>	<b>H412-41600-577M4</b>	–	



Rated data (IEC 60947)			Enclosure dimension (H × W × D) (mm)	Padlock device H-handle yellow/red
Operat. current $I_e$ (A)	Operational power (at 380–440 V) AC-23A (kW)	AC-3 (kW)		
				IP66
			Order code number	
160	75	45	440 × 320 × 255	<b>K616-41600-177H4</b>
315	132	55	640 × 320 × 330	<b>K830-41600-177H4</b>

\* larger terminal capacity, see page 154

Further switching programmes from page 132.

# Disconnect Switches

## Main/Emergency-Off Switches Enclosed Switches – Insulated Enclosure

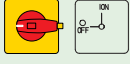
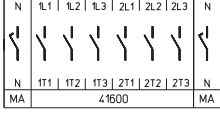
Switching programme	Rated data (IEC 60947)			Enclosure dimension (H × W × D) (mm)	Padlock device N-handle yellow/red	Padlock device M-handle yellow/red	Padlockable handle V-handle yellow/red
	Operat. current $I_e$	Operational power (at 380–440 V)					
		AC-21A (A)	AC-23A (kW)		AC-3 (kW)	IP66	IP66
					Order code number	Order code number	Order code number
<b>41800</b> – 8 pole – without auxiliary contacts – 2 neutral contacts – early make/late break  	20	5.5	3.7	250 × 160 × 120	<b>H216-41800-733N4</b>	<b>H216-41800-733M4</b>	<b>H216-41800-733V4</b>
	20	5.5	3.7	280 × 190 × 130	<b>H216-41800-770N4</b>	<b>H216-41800-770M4</b>	<b>H216-41800-770V4</b>
	25	7.5	5.5	250 × 160 × 120	<b>H220-41800-733N4</b>	<b>H220-41800-733M4</b>	<b>H220-41800-733V4</b>
	25	7.5	5.5	280 × 190 × 130	<b>H220-41800-770N4</b>	<b>H220-41800-770M4</b>	<b>H220-41800-770V4</b>
	32	11	7.5	250 × 160 × 120	<b>H226-41800-733N4</b>	<b>H226-41800-733M4</b>	<b>H226-41800-733V4</b>
	32	11	7.5	280 × 190 × 130	<b>H226-41800-770N4</b>	<b>H226-41800-770M4</b>	<b>H226-41800-770V4</b>
	40	15	11	250 × 160 × 120	<b>H233-41800-733N4</b>	<b>H233-41800-733M4</b>	<b>H233-41800-733V4</b>
	40	15	11	280 × 190 × 130	<b>H233-41800-770N4</b>	<b>H233-41800-770M4</b>	<b>H233-41800-770V4</b>
	40	15	11	280 × 190 × 130	<b>B240-41800-770N4*<sup>1</sup></b>	<b>B240-41800-770M4*<sup>1</sup></b>	<b>B240-41800-770V4*<sup>1</sup></b>
	40	15	11	320 × 220 × 180	<b>B240-41800-977N4</b>	<b>B240-41800-977M4</b>	–
	50	18.5	15	280 × 190 × 130	<b>B250-41800-770N4<sup>1</sup></b>	<b>B250-41800-770M4<sup>1</sup></b>	<b>B250-41800-770V4<sup>1</sup></b>
	50	18.5	15	320 × 220 × 180	<b>B250-41800-977N4</b>	<b>B250-41800-977M4</b>	–
	63	22	18.5	280 × 190 × 130	<b>B263-41800-770N4<sup>1</sup></b>	<b>B263-41800-770M4<sup>1</sup></b>	<b>B263-41800-770V4<sup>1</sup></b>
	63	22	18.5	320 × 220 × 180	<b>B263-41800-977N4</b>	<b>B263-41800-977M4</b>	–
	63	22	18.5	320 × 220 × 180	<b>H406-41800-977N4*</b>	<b>H406-41800-977M4*</b>	–
	63	22	18.5	440 × 320 × 180	<b>H406-41800-577N4</b>	<b>H406-41800-577M4</b>	–
	80	30	22	320 × 220 × 180	<b>H408-41800-977N4</b>	<b>H408-41800-977M4</b>	–
	80	30	22	440 × 320 × 180	<b>H408-41800-577N4</b>	<b>H408-41800-577M4</b>	–
	100	37	30	320 × 220 × 180	<b>H410-41800-977N4</b>	<b>H410-41800-977M4</b>	–
	100	37	30	440 × 320 × 180	<b>H410-41800-577N4</b>	<b>H410-41800-577M4</b>	–
125	45	37	320 × 220 × 180	<b>H412-41800-977N4</b>	<b>H412-41800-977M4</b>	–	
125	45	37	440 × 320 × 180	<b>H412-41800-577N4</b>	<b>H412-41800-577M4</b>	–	

Rated data (IEC 60947)			Enclosure dimension (H × W × D) (mm)	Padlock device H-handle yellow/red
Operat. current $I_e$	Operational power (at 380–440 V)			
AC-21A (A)	AC-23A (kW)	AC-3 (kW)		IP66
				Order code number
160	75	45	440 × 320 × 255	<b>K616-41800-177H4</b>
315	132	55	640 × 320 × 330	<b>K830-41800-177H4</b>

\* larger terminal capacity, see page 154

<sup>1</sup> Terminal capacity max. 16 mm<sup>2</sup> on N-terminal and/or PE-terminal

Further switching programmes from page 132.

## Dimensions in mm:

## Setup of order code number

Type	Switching progr.	Mtg. form
H216	41400	700M4
Order code no.	<b>H216-41400-700M4</b>	

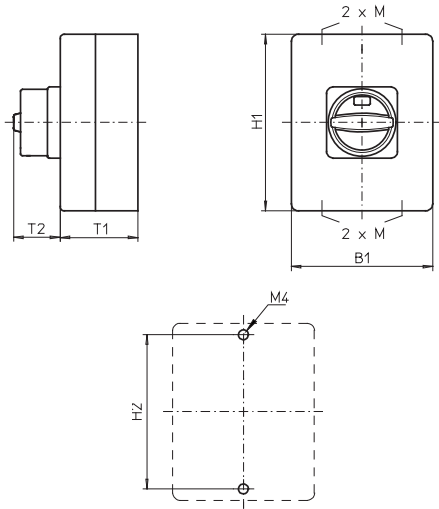
Insulated enclosures **125 × 100 × 85 mm**  
and **175 × 115 × 100 mm**:

Types H216 / H220 / H226 / H233 / B240 / B250 / B263:

Mtg. form	H1	B1	T1	T2	2×M	H2
700M4	125	100	85	38	20/25	115
700N4	125	100	85	33	20/25	115
700V4	125	100	85	32	20/25	115
710M4	175	115	100	38	20/25	165
710N4	175	115	100	33	20/25	165
710V4	175	115	100	39	20/25	165
720M4	175	115	100	38	20/25	165
720N4	175	115	100	33	20/25	165
720V4	175	115	100	39	20/25	165

Insulated enclosure **250 × 160 × 120 mm**:

Types H216 / H220 / H226 / H233:

Mtg. form	H1	B1	T1	T2	2×M	H2
730M4	250	160	120	38	32/40	235
730N4	250	160	120	33	32/40	235
730V4	250	160	120	39	32/40	235
733M4	250	160	120	38	32/40	235
733N4	250	160	120	33	32/40	235
733V4	250	160	120	39	32/40	235

Types B240 / B250 / B263:

Mtg. form	H1	B1	T1	T2	2×M	H2
730M4	250	160	120	50	32/40	235
730N4	250	160	120	45	32/40	235
730V4	250	160	120	39	32/40	235

Types H406 / H408 / H410 / H412:

Mtg. form	H1	B1	T1	T2	2×M	H2
730M4	250	160	120	50	32/40	235
730N4	250	160	120	45	32/40	235

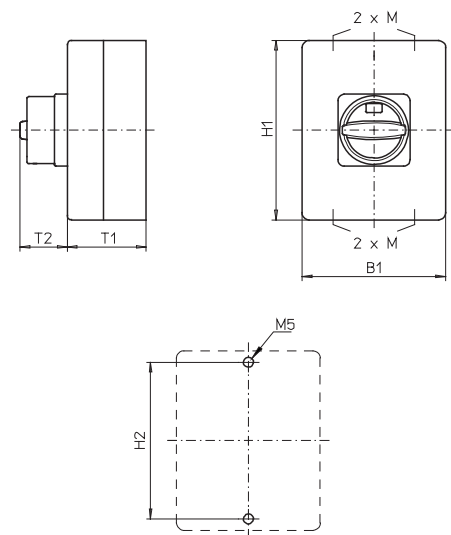



# Disconnect Switches

## Main/Emergency-Off Switches Enclosed Switches – Insulated Enclosure

Dimensions in mm:

**Setup of order code number**

Type	Switching progr.	Mtg. form
H406	41300	770M4
Order code no.	<b>H406-41300-770M4</b>	

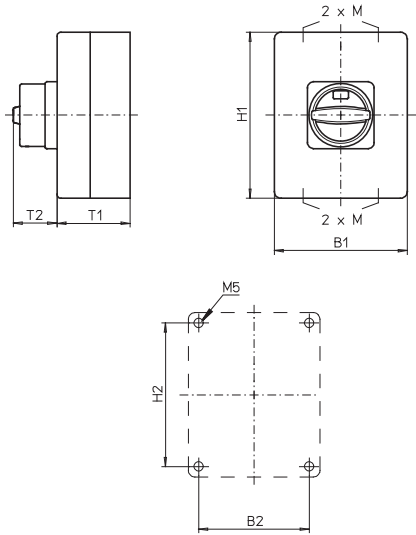

Insulated enclosures **280 × 190 × 130 mm**  
and **320 × 220 × 180 mm**:

Types H216 / H220 / H226 / H233 / B240 / B250 / B263 /  
H406 / H408 / H410 / H412:

Mtg. form	H1	B1	T1	T2	2×M	H2	B2
770M4	280	190	130	50	40×1.5	254	164
770N4	280	190	130	45	40×1.5	254	164
770V4	280	190	130	39	40×1.5	254	164
477M4	320	220	180	50	50 <sup>1</sup>	293	193
477N4	320	220	180	45	50 <sup>1</sup>	293	193
977M4	320	220	180	50	– <sup>2</sup>	293	193
977N4	320	220	180	45	– <sup>2</sup>	293	193

<sup>1</sup> Gland plates with knockouts

<sup>2</sup> Blank gland plates

Insulated enclosures **440 × 320 × 180 mm /**  
**440 × 320 × 255 mm / 640 × 320 × 255 mm /**  
**640 × 320 × 330 mm:**

Types H406 / H408 / H410 / H412:

Mtg. form	H1	B1	T1	T2	H2	B2
577M4	440	320	180	50	480	293
577N4	440	320	180	45	480	293

Type K616:

Mtg. form	H1	B1	T1	T2	H2	B2
077H4	440	320	180	83	480	293
177H4	440	320	255	83	480	293

Type K830:

Mtg. form	H1	B1	T1	T2	H2	B2
077H4	640	320	255	93	680	293
177H4	640	320	330	93	680	293

Further switching programmes and corresponding dimensions for types K on request.

Blank gland plates

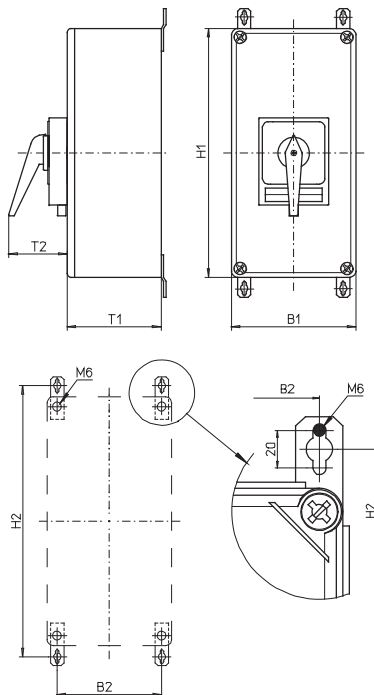

Mounting brackets are included.

## Main/Emergency-Off Switches

- Enclosed switches with insulated enclosure (polycarbonate)
- EMV/EMC application, connection system for the uninterrupted connection of shielded/screened cables consisting of shroud and 4 shroud clamps  $\varnothing$  12–16 mm
- Cover interlock in ON position
- 3 up to 6 pole
- 20 A up to 63 A
- IP66



Switching programme	Rated data (IEC 60947)			Enclosure dimension (H x W x D) (mm)	Padlock device N-handle yellow/red	Padlock device M-handle yellow/red	Padlockable handle V-handle yellow/red
	Operat. current $I_e$	Operational power (at 380–440 V)					
	AC-21A (A)	AC-23A (kW)	AC-3 (kW)		IP66	IP66	IP66
				Order code number	Order code number	Order code number	
<b>41300</b> – 3 pole – without auxiliary contacts 	20	5.5	3.7	175 x 115 x 100	<b>H216-41300-715N4</b>	<b>H216-41300-715M4</b>	<b>H216-41300-715V4</b>
	25	7.5	5.5	175 x 115 x 100	<b>H220-41300-715N4</b>	<b>H220-41300-715M4</b>	<b>H220-41300-715V4</b>
	32	11	7.5	175 x 115 x 100	<b>H226-41300-715N4</b>	<b>H226-41300-715M4</b>	<b>H226-41300-715V4</b>
	40	15	11	175 x 115 x 100	<b>H233-41300-715N4</b>	<b>H233-41300-715M4</b>	<b>H233-41300-715V4</b>
	40	15	11	175 x 115 x 100	<b>B240-41300-715N4*</b>	<b>B240-41300-715M4*</b>	<b>B240-41300-715V4*</b>
	50	18.5	15	175 x 115 x 100	<b>B250-41300-715N4</b>	<b>B250-41300-715M4</b>	<b>B250-41300-715V4</b>
	63	22	18.5	175 x 115 x 100	<b>B263-41300-715N4</b>	<b>B263-41300-715M4</b>	<b>B263-41300-715V4</b>
<b>41400</b> – 4 pole – without auxiliary contacts – neutral contact early make/late break 	20	5.5	3.7	175 x 115 x 100	<b>H216-41400-715N4</b>	<b>H216-41400-715M4</b>	<b>H216-41400-715V4</b>
	25	7.5	5.5	175 x 115 x 100	<b>H220-41400-715N4</b>	<b>H220-41400-715M4</b>	<b>H220-41400-715V4</b>
	32	11	7.5	175 x 115 x 100	<b>H226-41400-715N4</b>	<b>H226-41400-715M4</b>	<b>H226-41400-715V4</b>
	40	15	11	175 x 115 x 100	<b>H233-41400-715N4</b>	<b>H233-41400-715M4</b>	<b>H233-41400-715V4</b>
	40	15	11	175 x 115 x 100	<b>B240-41400-715N4*</b>	<b>B240-41400-715M4*</b>	<b>B240-41400-715V4*</b>
	50	18.5	15	175 x 115 x 100	<b>B250-41400-715N4</b>	<b>B250-41400-715M4</b>	<b>B250-41400-715V4</b>
	63	22	18.5	175 x 115 x 100	<b>B263-41400-715N4</b>	<b>B263-41400-715M4</b>	<b>B263-41400-715V4</b>
<b>41600</b> – 6 pole – without auxiliary contacts 	20	5.5	3.7	175 x 115 x 100	<b>H216-41600-725N4</b>	<b>H216-41600-725M4</b>	<b>H216-41600-725V4</b>
	25	7.5	5.5	175 x 115 x 100	<b>H220-41600-725N4</b>	<b>H220-41600-725M4</b>	<b>H220-41600-725V4</b>
	32	11	7.5	175 x 115 x 100	<b>H226-41600-725N4</b>	<b>H226-41600-725M4</b>	<b>H226-41600-725V4</b>
	40	15	11	175 x 115 x 100	<b>H233-41600-725N4</b>	<b>H233-41600-725M4</b>	<b>H233-41600-725V4</b>

\* larger terminal capacity, see page 154  
Further switching programmes from page 132.

### Dimensions in mm:

Types H216 / H220 / H226 / H233 / B240 / B250 / B263:

Mtg. form	H1	B1	T1	T2	2xM	H2
715M4	175	115	100	38	20/25	165
715N4	175	115	100	33	20/25	165
715V4	175	115	100	39	20/25	165
725M4	175	115	100	38	20/25	165
725N4	175	115	100	33	20/25	165
725V4	175	115	100	39	20/25	165



# Disconnect Switches

Main/Emergency-Off Switches Enclosed Switches – Mild Steel Enclosure

## Main/Emergency-Off Switches

- Enclosed switches with mild steel enclosure (powder coated – RAL 7035)
- Cover interlock in ON position
- 3 up to 8 pole
- 20 A up to 315 A
- IP66



Switching programme	Rated data (IEC 60947)			Enclosure dimension (H × W × D) (mm)	Padlock device N-handle yellow/red	Padlock device M-handle yellow/red	Padlockable handle V-handle yellow/red
	Operat. current I <sub>e</sub> (A)	Operational power (at 380–440 V) (kW)			 IP66	 IP66	 IP66
	AC-21A	AC-23A	AC-3		Order code number	Order code number	Order code number
<b>41300</b> – 3 pole – without auxiliary contacts 	20	5.5	3.7	150 × 150 × 120	<b>H216-41300-087N4</b>	<b>H216-41300-087M4</b>	<b>H216-41300-087V4</b>
	20	5.5	3.7	200 × 150 × 120	<b>H216-41300-187N4</b>	<b>H216-41300-187M4</b>	<b>H216-41300-187V4</b>
	25	7.5	5.5	150 × 150 × 120	<b>H220-41300-087N4</b>	<b>H220-41300-087M4</b>	<b>H220-41300-087V4</b>
	25	7.5	5.5	200 × 150 × 120	<b>H220-41300-187N4</b>	<b>H220-41300-187M4</b>	<b>H220-41300-187V4</b>
	32	11	7.5	150 × 150 × 120	<b>H226-41300-087N4</b>	<b>H226-41300-087M4</b>	<b>H226-41300-087V4</b>
	32	11	7.5	200 × 150 × 120	<b>H226-41300-187N4</b>	<b>H226-41300-187M4</b>	<b>H226-41300-187V4</b>
	40	15	11	200 × 150 × 120	<b>H233-41300-187N4</b>	<b>H233-41300-187M4</b>	<b>H233-41300-187V4</b>
	40	15	11	200 × 150 × 120	<b>B240-41300-087N4*</b>	<b>B240-41300-087M4*</b>	<b>B240-41300-087V4*</b>
	50	18.5	15	200 × 150 × 120	<b>B250-41300-087N4</b>	<b>B250-41300-087M4</b>	<b>B250-41300-087V4</b>
	63	22	18.5	200 × 150 × 120	<b>B263-41300-087N4</b>	<b>B263-41300-087M4</b>	<b>B263-41300-087V4</b>
	63	22	18.5	200 × 150 × 120	<b>H406-41300-987N4*</b>	<b>H406-41300-987M4*</b>	–
	63	22	18.5	300 × 250 × 150	<b>H406-41300-187N4</b>	<b>H406-41300-187M4</b>	–
	63	22	18.5	400 × 300 × 155	<b>H406-41300-182N4<sup>1</sup></b>	<b>H406-41300-182M4<sup>1</sup></b>	–
	80	30	22	200 × 150 × 120	<b>H408-41300-987N4</b>	<b>H408-41300-987M4</b>	–
	80	30	22	300 × 250 × 150	<b>H408-41300-187N4</b>	<b>H408-41300-187M4</b>	–
	80	30	22	400 × 300 × 155	<b>H408-41300-182N4<sup>1</sup></b>	<b>H408-41300-182M4<sup>1</sup></b>	–
100	37	30	300 × 250 × 150	<b>H410-41300-187N4</b>	<b>H410-41300-187M4</b>	–	
100	37	30	400 × 300 × 155	<b>H410-41300-182N4<sup>1</sup></b>	<b>H410-41300-182M4<sup>1</sup></b>	–	
125	45	37	300 × 250 × 150	<b>H412-41300-187N4</b>	<b>H412-41300-187M4</b>	–	
125	45	37	400 × 300 × 155	<b>H412-41300-182N4<sup>1</sup></b>	<b>H412-41300-182M4<sup>1</sup></b>	–	

Rated data (IEC 60947)			Enclosure dimension (H × W × D) (mm)	Padlock device H-handle yellow/red	
Operat. current I <sub>e</sub> (A)	Operational power (at 380–440 V) (kW)			 IP66	Order code number
160	75	45	500 × 400 × 300	<b>K616-41300-187H4<sup>1</sup></b>	
315	132	55	600 × 400 × 300	<b>K830-41300-187H4<sup>1</sup></b>	
315	132	55	800 × 400 × 300	<b>K830-41300-287H4<sup>1</sup></b>	

\* larger terminal capacity, see page 154

<sup>1</sup> hinged door

Further switching programmes from page 132.

# Disconnect Switches

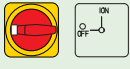
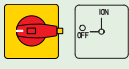
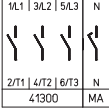

## Main/Emergency-Off Switches Enclosed Switches – Mild Steel Enclosure

Switching programme	Rated data (IEC 60947)			Enclosure dimension (H × W × D) (mm)	Padlock device N-handle yellow/red	Padlock device M-handle yellow/red	Padlockable handle V-handle yellow/red
	Operat. current $I_e$ (A)	Operational power (at 380–440 V) (kW)			 IP66	 IP66	 IP66
		AC-21A	AC-23A		AC-3	Order code number	Order code number
<b>41400</b> – 4 pole – without auxiliary contacts – neutral contact – early make/late break  	20	5.5	3.7	150 × 150 × 120	<b>H216-41400-087N4</b>	<b>H216-41400-087M4</b>	<b>H216-41400-087V4</b>
	20	5.5	3.7	200 × 150 × 120	<b>H216-41400-187N4</b>	<b>H216-41400-187M4</b>	<b>H216-41400-187V4</b>
	25	7.5	5.5	150 × 150 × 120	<b>H220-41400-087N4</b>	<b>H220-41400-087M4</b>	<b>H220-41400-087V4</b>
	25	7.5	5.5	200 × 150 × 120	<b>H220-41400-187N4</b>	<b>H220-41400-187M4</b>	<b>H220-41400-187V4</b>
	32	11	7.5	150 × 150 × 120	<b>H226-41400-087N4</b>	<b>H226-41400-087M4</b>	<b>H226-41400-087V4</b>
	32	11	7.5	200 × 150 × 120	<b>H226-41400-187N4</b>	<b>H226-41400-187M4</b>	<b>H226-41400-187V4</b>
	40	15	11	200 × 150 × 120	<b>H233-41400-187N4</b>	<b>H233-41400-187M4</b>	<b>H233-41400-187V4</b>
	40	15	11	200 × 150 × 120	<b>B240-41400-087N4*</b>	<b>B240-41400-087M4*</b>	<b>B240-41400-087V4*</b>
	50	18.5	15	200 × 150 × 120	<b>B250-41400-087N4</b>	<b>B250-41400-087M4</b>	<b>B250-41400-087V4</b>
	63	22	18.5	200 × 150 × 120	<b>B263-41400-087N4</b>	<b>B263-41400-087M4</b>	<b>B263-41400-087V4</b>
	63	22	18.5	200 × 150 × 120	<b>H406-41400-987N4*</b>	<b>H406-41400-987M4*</b>	–
	63	22	18.5	300 × 250 × 150	<b>H406-41400-187N4</b>	<b>H406-41400-187M4</b>	–
	63	22	18.5	400 × 300 × 155	<b>H406-41400-182N4<sup>1</sup></b>	<b>H406-41400-182M4<sup>1</sup></b>	–
	80	30	22	200 × 150 × 120	<b>H408-41400-987N4</b>	<b>H408-41400-987M4</b>	–
	80	30	22	300 × 250 × 150	<b>H408-41400-187N4</b>	<b>H408-41400-187M4</b>	–
	80	30	22	400 × 300 × 155	<b>H408-41400-182N4<sup>1</sup></b>	<b>H408-41400-182M4<sup>1</sup></b>	–
100	37	30	300 × 250 × 150	<b>H410-41400-187N4</b>	<b>H410-41400-187M4</b>	–	
100	37	30	400 × 300 × 155	<b>H410-41400-182N4<sup>1</sup></b>	<b>H410-41400-182M4<sup>1</sup></b>	–	
125	45	37	300 × 250 × 150	<b>H412-41400-187N4</b>	<b>H412-41400-187M4</b>	–	
125	45	37	400 × 300 × 155	<b>H412-41400-182N4<sup>1</sup></b>	<b>H412-41400-182M4<sup>1</sup></b>	–	

Rated data (IEC 60947)			Enclosure dimension (H × W × D) (mm)	Padlock device H-handle yellow/red
Operat. current $I_e$ (A)	Operational power (at 380–440 V) (kW)			 IP66
	AC-21A	AC-23A		AC-3
160	75	45	500 × 400 × 300	<b>K616-41400-187H4<sup>1</sup></b>
315	132	55	600 × 400 × 300	<b>K830-41400-187H4<sup>1</sup></b>
315	132	55	800 × 400 × 300	<b>K830-41400-287H4<sup>1</sup></b>



\* larger terminal capacity, see page 154

<sup>1</sup> hinged door

Further switching programmes from page 132.

# Disconnect Switches

## Main/Emergency-Off Switches Enclosed Switches – Mild Steel Enclosure

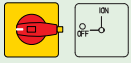
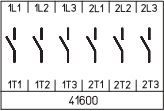
Switching programme	Rated data (IEC 60947)			Enclosure dimension (H × W × D) (mm)	Padlock device N-handle yellow/red	Padlock device M-handle yellow/red	Padlockable handle V-handle yellow/red
	Operat. current $I_e$	Operational power (at 380–440 V)			 IP66	 IP66	 IP66
	AC-21A (A)	AC-23A (kW)	AC-3 (kW)		Order code number	Order code number	Order code number
<b>41600</b> – 6 pole – without auxiliary contacts 	20	5.5	3.7	200 × 150 × 120	<b>H216-41600-187N4</b>	<b>H216-41600-187M4</b>	<b>H216-41600-187V4</b>
	25	7.5	5.5	200 × 150 × 120	<b>H220-41600-187N4</b>	<b>H220-41600-187M4</b>	<b>H220-41600-187V4</b>
	32	11	7.5	200 × 150 × 120	<b>H226-41600-187N4</b>	<b>H226-41600-187M4</b>	<b>H226-41600-187V4</b>
	40	15	11	200 × 150 × 120	<b>H233-41600-187N4</b>	<b>H233-41600-187M4</b>	<b>H233-41600-187V4</b>
	40	15	11	300 × 250 × 150	<b>B240-41600-187N4</b>	<b>B240-41600-187M4</b>	–
	50	18.5	15	300 × 250 × 150	<b>B250-41600-187N4</b>	<b>B250-41600-187M4</b>	–
	63	22	18.5	300 × 250 × 150	<b>B263-41600-187N4</b>	<b>B263-41600-187M4</b>	–
	63	22	18.5	300 × 250 × 150	<b>H406-41600-187N4*</b>	<b>H406-41600-187M4*</b>	–
	63	22	18.5	400 × 300 × 155	<b>H406-41600-182N4<sup>1</sup></b>	<b>H406-41600-182M4<sup>1</sup></b>	–
	80	30	22	300 × 250 × 150	<b>H408-41600-187N4</b>	<b>H408-41600-187M4</b>	–
	80	30	22	400 × 300 × 155	<b>H408-41600-182N4<sup>1</sup></b>	<b>H408-41600-182M4<sup>1</sup></b>	–
	100	37	30	300 × 250 × 150	<b>H410-41600-187N4</b>	<b>H410-41600-187M4</b>	–
	100	37	30	400 × 300 × 155	<b>H410-41600-182N4<sup>1</sup></b>	<b>H410-41600-182M4<sup>1</sup></b>	–
	125	45	37	300 × 250 × 150	<b>H412-41600-187N4</b>	<b>H412-41600-187M4</b>	–
	125	45	37	400 × 300 × 155	<b>H412-41600-182N4<sup>1</sup></b>	<b>H412-41600-182M4<sup>1</sup></b>	–

Rated data (IEC 60947)			Enclosure dimension (H × W × D) (mm)	Padlock device H-handle yellow/red
Operat. current $I_e$	Operational power (at 380–440 V)			 IP66
AC-21A (A)	AC-23A (kW)	AC-3 (kW)		Order code number
160	75	45	500 × 400 × 300	<b>K616-41600-187H4<sup>1</sup></b>
315	132	55	600 × 400 × 300	<b>K830-41600-187H4<sup>1</sup></b>
315	132	55	800 × 400 × 300	<b>K830-41600-287H4<sup>1</sup></b>

\* larger terminal capacity, see page 154

<sup>1</sup> hinged door

Further switching programmes from page 132.

# Disconnect Switches

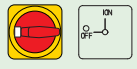
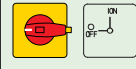
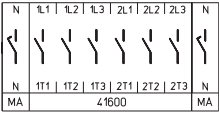

## Main/Emergency-Off Switches Enclosed Switches – Mild Steel Enclosure

Switching programme	Rated data (IEC 60947)			Enclosure dimension (H × W × D) (mm)	Padlock device N-handle yellow/red	Padlock device M-handle yellow/red	Padlockable handle V-handle yellow/red
	Operat. current I <sub>e</sub>	Operational power (at 380–440 V)			 IP66	 IP66	 IP66
	AC-21A (A)	AC-23A (kW)	AC-3 (kW)		Order code number	Order code number	Order code number
<b>41800</b> – 8 pole – without auxiliary contacts – 2 neutral contacts – early make/late break  	20	5.5	3.7	200 × 150 × 120	<b>H216-41800-187N4</b>	<b>H216-41800-187M4</b>	<b>H216-41800-187V4</b>
	25	7.5	5.5	200 × 150 × 120	<b>H220-41800-187N4</b>	<b>H220-41800-187M4</b>	<b>H220-41800-187V4</b>
	32	11	7.5	200 × 150 × 120	<b>H226-41800-187N4</b>	<b>H226-41800-187M4</b>	<b>H226-41800-187V4</b>
	40	15	11	200 × 150 × 120	<b>H233-41800-187N4</b>	<b>H233-41800-187M4</b>	<b>H233-41800-187V4</b>
	40	15	11	300 × 250 × 150	<b>B240-41800-187N4</b>	<b>B240-41800-187M4</b>	–
	50	18.5	15	300 × 250 × 150	<b>B250-41800-187N4</b>	<b>B250-41800-187M4</b>	–
	63	22	18.5	300 × 250 × 150	<b>B263-41800-187N4</b>	<b>B263-41800-187M4</b>	–
	63	22	18.5	300 × 250 × 150	<b>H406-41800-187N4*</b>	<b>H406-41800-187M4*</b>	–
	63	22	18.5	400 × 300 × 155	<b>H406-41800-182N4<sup>1</sup></b>	<b>H406-41800-182M4<sup>1</sup></b>	–
	80	30	22	300 × 250 × 150	<b>H408-41800-187N4</b>	<b>H408-41800-187M4</b>	–
	80	30	22	400 × 300 × 155	<b>H408-41800-182N4<sup>1</sup></b>	<b>H408-41800-182M4<sup>1</sup></b>	–
	100	37	30	300 × 250 × 150	<b>H410-41800-187N4</b>	<b>H410-41800-187M4</b>	–
	100	37	30	400 × 300 × 155	<b>H410-41800-182N4<sup>1</sup></b>	<b>H410-41800-182M4<sup>1</sup></b>	–
	125	45	37	300 × 250 × 150	<b>H412-41800-187N4</b>	<b>H412-41800-187M4</b>	–
	125	45	37	400 × 300 × 155	<b>H412-41800-182N4<sup>1</sup></b>	<b>H412-41800-182M4<sup>1</sup></b>	–

Rated data (IEC 60947)			Enclosure dimension (H × W × D) (mm)	Padlock device H-handle yellow/red
Operat. current I <sub>e</sub>	Operational power (at 380–440 V)			 IP66
AC-21A (A)	AC-23A (kW)	AC-3 (kW)		Order code number
160	75	45	500 × 400 × 300	<b>K616-41800-187H4<sup>1</sup></b>
315	132	55	600 × 400 × 300	<b>K830-41800-187H4<sup>1</sup></b>
315	132	55	800 × 400 × 300	<b>K830-41800-287H4<sup>1</sup></b>

\* larger terminal capacity, see page 154

<sup>1</sup> hinged door

Further switching programmes from page 132.

# Disconnect Switches

## Main/Emergency-Off Switches Enclosed Switches – Mild Steel Enclosure

Dimensions in mm:

**Setup of order code number**

Type	Switching progr.	Mtg. form
H216	41400	087M4
Order code no.	<b>H216-41400-087M4</b>	

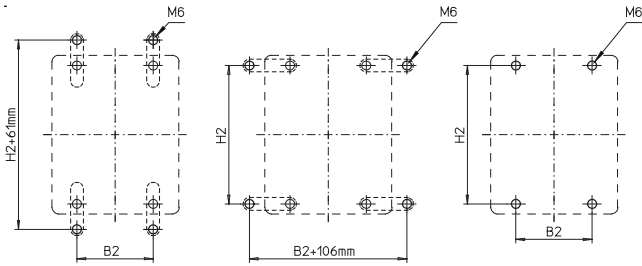
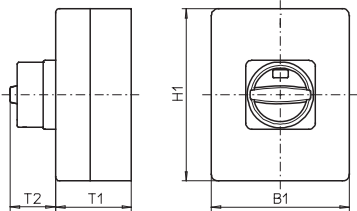

Please order mounting brackets separately, see page 148.

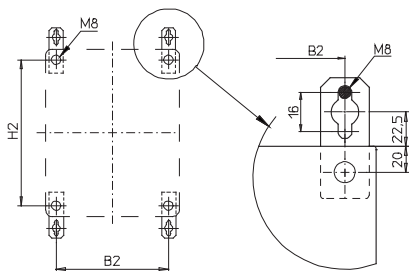
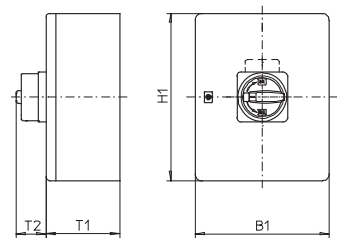

Please order mounting brackets separately, see page 148.

Mild steel enclosures **150 × 150 × 120 mm / 200 × 150 × 120 mm / 300 × 250 × 150 mm:**

Types H216 / H220 / H226 / H233:

Mtg. form	H1	B1	T1	T2	H2	B2
087M4	150	150	120	38	132	85
087N4	150	150	120	33	132	85
087V4	150	150	120	39	132	85
187M4	200	150	120	38	182	85
187N4	200	150	120	33	182	85
187V4	200	150	120	39	182	85

Types B240 / B250 / B263:

Mtg. form	H1	B1	T1	T2	H2	B2
087M4	200	150	120	38	182	85
087N4	200	150	120	33	182	85
087V4	200	150	120	39	182	85
187M4	300	250	150	50	282	185
187N4	300	250	150	45	282	185

Types H406 / H408 / H410 / H412:

Mtg. form	H1	B1	T1	T2	H2	B2
187M4	300	250	150	50	282	185
187N4	300	250	150	45	282	185
987M4	200	150	120	50	182	85
987N4	200	150	120	45	182	85

Mild steel enclosures **400 × 300 × 155 mm:**

Types H406 / H408 / H410 / H412:

Mtg. form	H1	B1	T1	T2	H2	B2
182M4	400	300	155	50	360	260
182N4	400	300	155	45	360	260

Gland plate at the bottom

# Disconnect Switches

Main/Emergency-Off Switches Enclosed Switches – Mild Steel Enclosure

Dimensions in mm:

Setup of order code number		
Type	Switching progr.	Mtg. form
K616	41300	187H4
Order code no.	<b>K616-41300-187H4</b>	

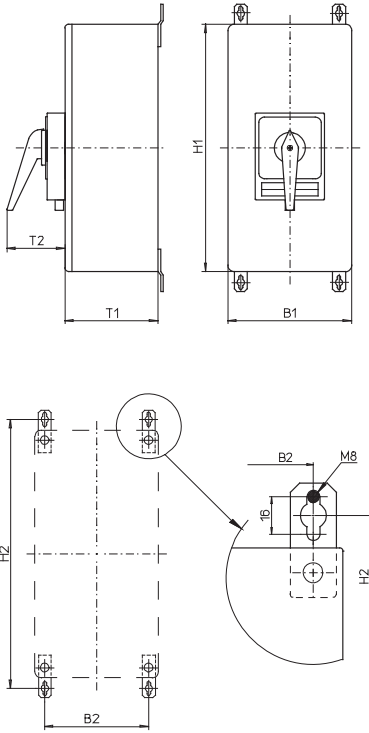

Mounting brackets are included.

Mild steel enclosures **500 × 400 × 300 mm / 600 × 400 × 300 mm / 800 × 400 × 300 mm:**

Type K616:

Mtg. form	H1	B1	T1	T2	H2	B2
187H4	500	400	300	83	545	360

Type K830:

Mtg. form	H1	B1	T1	T2	H2	B2
187H4	600	400	300	93	645	360
287H4	800	400	300	93	845	360

Further switching programmes and corresponding dimensions for types K on request.

Gland plate at the bottom





# Disconnect Switches

Main/Emergency-Off Switches Enclosed Switches – Stainless Steel Enclosure

## Main/Emergency-Off Switches

- Enclosed switches with stainless steel enclosure (brushed)
- Cover interlock in ON position
- 3 up to 8 pole
- 20 A up to 125 A
- IP66

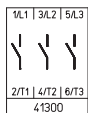
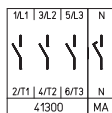

Switching programme	Rated data (IEC 60947)			Enclosure dimension (H × W × D) (mm)	Padlock device N-handle yellow/red	Padlock device M-handle yellow/red	Padlockable handle V-handle yellow/red
	Operat. current I <sub>e</sub> (A)	Operational power (at 380–440 V) (kW)			 IP66	 IP66	 IP66
	AC-21A	AC-23A	AC-3		Order code number	Order code number	Order code number
<b>41300</b> – 3 pole – without auxiliary contacts 	20	5.5	3.7	150 × 150 × 120	H216-41300-097N4	H216-41300-097M4	H216-41300-097V4
	20	5.5	3.7	200 × 150 × 120	H216-41300-197N4	H216-41300-197M4	H216-41300-197V4
	25	7.5	5.5	150 × 150 × 120	H220-41300-097N4	H220-41300-097M4	H220-41300-097V4
	25	7.5	5.5	200 × 150 × 120	H220-41300-197N4	H220-41300-197M4	H220-41300-197V4
	32	11	7.5	150 × 150 × 120	H226-41300-097N4	H226-41300-097M4	H226-41300-097V4
	32	11	7.5	200 × 150 × 120	H226-41300-197N4	H226-41300-197M4	H226-41300-197V4
	40	15	11	200 × 150 × 120	H233-41300-197N4	H233-41300-197M4	H233-41300-197V4
	40	15	11	200 × 150 × 120	B240-41300-097N4*	B240-41300-097M4*	B240-41300-097V4*
	50	18.5	15	200 × 150 × 120	B250-41300-097N4	B250-41300-097M4	B250-41300-097V4
	63	22	18.5	200 × 150 × 120	B263-41300-097N4	B263-41300-097M4	B263-41300-097V4
	63	22	18.5	200 × 150 × 120	H406-41300-997N4*	H406-41300-997M4*	–
	63	22	18.5	300 × 250 × 150	H406-41300-197N4	H406-41300-197M4	–
	80	30	22	200 × 150 × 120	H408-41300-997N4	H408-41300-997M4	–
	80	30	22	300 × 250 × 150	H408-41300-197N4	H408-41300-197M4	–
100	37	30	300 × 250 × 150	H410-41300-197N4	H410-41300-197M4	–	
125	45	37	300 × 250 × 150	H412-41300-197N4	H412-41300-197M4	–	
<b>41400</b> – 4 pole – without auxiliary contacts – neutral contact early make/late break 	20	5.5	3.7	150 × 150 × 120	H216-41400-097N4	H216-41400-097M4	H216-41400-097V4
	20	5.5	3.7	200 × 150 × 120	H216-41400-197N4	H216-41400-197M4	H216-41400-197V4
	25	7.5	5.5	150 × 150 × 120	H220-41400-097N4	H220-41400-097M4	H220-41400-097V4
	25	7.5	5.5	200 × 150 × 120	H220-41400-197N4	H220-41400-197M4	H220-41400-197V4
	32	11	7.5	150 × 150 × 120	H226-41400-097N4	H226-41400-097M4	H226-41400-097V4
	32	11	7.5	200 × 150 × 120	H226-41400-197N4	H226-41400-197M4	H226-41400-197V4
	40	15	11	200 × 150 × 120	H233-41400-197N4	H233-41400-197M4	H233-41400-197V4
	40	15	11	200 × 150 × 120	B240-41400-097N4*	B240-41400-097M4*	B240-41400-097V4*
	50	18.5	15	200 × 150 × 120	B250-41400-097N4	B250-41400-097M4	B250-41400-097V4
	63	22	18.5	200 × 150 × 120	B263-41400-097N4	B263-41400-097M4	B263-41400-097V4
	63	22	18.5	200 × 150 × 120	H406-41400-997N4*	H406-41400-997M4*	–
	63	22	18.5	300 × 250 × 150	H406-41400-197N4	H406-41400-197M4	–
	80	30	22	200 × 150 × 120	H408-41400-997N4	H408-41400-997M4	–
	80	30	22	300 × 250 × 150	H408-41400-197N4	H408-41400-197M4	–
100	37	30	300 × 250 × 150	H410-41400-197N4	H410-41400-197M4	–	
125	45	37	300 × 250 × 150	H412-41400-197N4	H412-41400-197M4	–	

\* larger terminal capacity, see page 154

Further switching programmes from page 132.

# Disconnect Switches

Main/Emergency-Off Switches Enclosed Switches – Stainless Steel Enclosure

Switching programme	Rated data (IEC 60947)			Enclosure dimension (H × W × D) (mm)	Padlock device N-handle yellow/red	Padlock device M-handle yellow/red	Padlockable handle V-handle yellow/red
	Operat. current I <sub>e</sub>	Operational power (at 380–440 V)			IP66	IP66	IP66
		AC-21A (A)	AC-23A (kW)				
				Order code number	Order code number	Order code number	
<b>41600</b> – 6 pole – without auxiliary contacts 	20	5.5	3.7	200 × 150 × 120	H216-41600-197N4	H216-41600-197M4	H216-41600-197V4
	25	7.5	5.5	200 × 150 × 120	H220-41600-197N4	H220-41600-197M4	H220-41600-197V4
	32	11	7.5	200 × 150 × 120	H226-41600-197N4	H226-41600-197M4	H226-41600-197V4
	40	15	11	200 × 150 × 120	H233-41600-197N4	H233-41600-197M4	H233-41600-197V4
	40	15	11	300 × 250 × 150	B240-41600-197N4	B240-41600-197M4	–
	50	18.5	15	300 × 250 × 150	B250-41600-197N4	B250-41600-197M4	–
	63	22	18.5	300 × 250 × 150	B263-41600-197N4	B263-41600-197M4	–
	63	22	18.5	300 × 250 × 150	H406-41600-197N4*	H406-41600-197M4*	–
	80	30	22	300 × 250 × 150	H408-41600-197N4	H408-41600-197M4	–
	100	37	30	300 × 250 × 150	H410-41600-197N4	H410-41600-197M4	–
125	45	37	300 × 250 × 150	H412-41600-197N4	H412-41600-197M4	–	
<b>41800</b> – 8 pole – without auxiliary contacts – 2 neutral contacts early make/late break 	20	5.5	3.7	200 × 150 × 120	H216-41800-197N4	H216-41800-197M4	H216-41800-197V4
	25	7.5	5.5	200 × 150 × 120	H220-41800-197N4	H220-41800-197M4	H220-41800-197V4
	32	11	7.5	200 × 150 × 120	H226-41800-197N4	H226-41800-197M4	H226-41800-197V4
	40	15	11	200 × 150 × 120	H233-41800-197N4	H233-41800-197M4	H233-41800-197V4
	40	15	11	300 × 250 × 150	B240-41800-197N4	B240-41800-197M4	–
	50	18.5	15	300 × 250 × 150	B250-41800-197N4	B250-41800-197M4	–
	63	22	18.5	300 × 250 × 150	B263-41800-197N4	B263-41800-197M4	–
	63	22	18.5	300 × 250 × 150	H406-41800-197N4*	H406-41800-197M4*	–
	80	30	22	300 × 250 × 150	H408-41800-197N4	H408-41800-197M4	–
	100	37	30	300 × 250 × 150	H410-41800-197N4	H410-41800-197M4	–
125	45	37	300 × 250 × 150	H412-41800-197N4	H412-41800-197M4	–	

\* larger terminal capacity, see page 154

Further switching programmes from page 132.

## Dimensions in mm:

### Setup of order code number

Type	Switching progr.	Mtg. form
B263	41800	197V4
Order code no.	<b>B263-41800-197V4</b>	

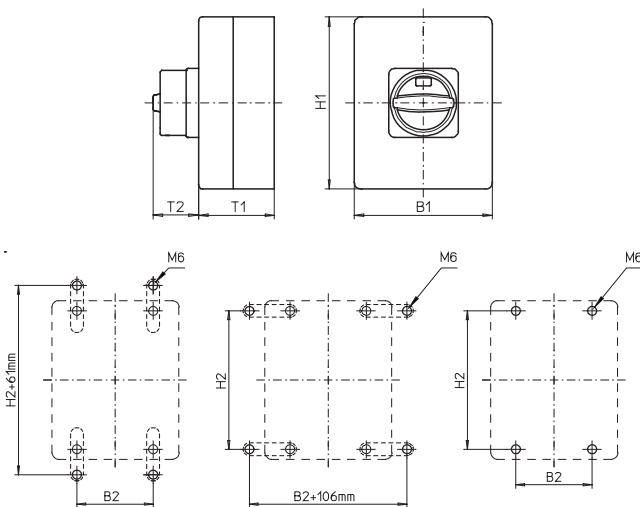

Please order mounting brackets separately, see page 148.

### Types H216 / H220 / H226 / H233:

Mtg. form	H1	B1	T1	T2	H2	B2
097M4	150	150	120	38	132	85
097N4	150	150	120	33	132	85
097V4	150	150	120	39	132	85
197M4	200	150	120	38	182	85
197N4	200	150	120	33	182	85
197V4	200	150	120	39	182	85

### Types B240 / B250 / B263:

Mtg. form	H1	B1	T1	T2	H2	B2
097M4	200	150	120	38	182	85
097N4	200	150	120	33	182	85
097V4	200	150	120	39	182	85
197M4	300	250	150	50	282	185
197N4	300	250	150	45	282	185

### Types H406 / H408 / H410 / H412:

Mtg. form	H1	B1	T1	T2	H2	B2
197M4	300	250	150	50	282	185
197N4	300	250	150	45	282	185
997M4	200	150	120	50	182	85
997N4	200	150	120	45	182	85