

# REP Series

Environmentally-Sealed Rectangular Plastic Connectors

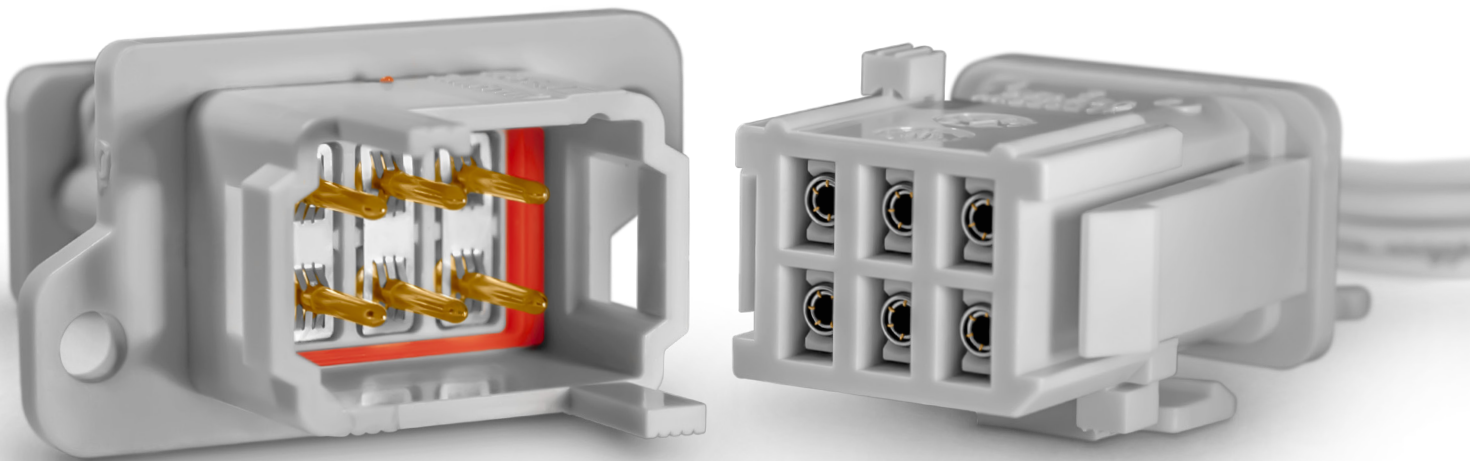

## Disclaimer 2022

All of the information included in this catalogue is believed to be accurate at the time of printing. It is recommended, however, that users should independently evaluate the suitability of each product for their intended application and be sure that each product is properly installed, used and maintained to achieve desired results.

Smiths Interconnect makes no warranties as to the accuracy or completeness of the information, and disclaims any liability regarding its use.

Smiths Interconnect reserves the right to modify design and specifications, in order to improve quality, keep pace with technological development or meet specific production requirements.

No reproduction or use without express permission of editorial and pictorial content, in any manner.

# REP Series

Environmentally - Sealed Rectangular Plastic Connectors

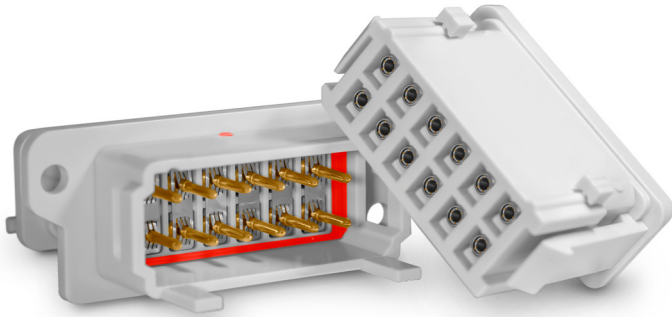

Optimised for  
use in rail and  
embedded  
applications

Smiths Interconnectors' REP Series of multi-pole, sealed, and plastic connectors, provides a quick and secure connection of embedded equipment across a wide range of applications, such as sensors, brakes, lighting, air conditioning and communications found within industrial, rail, test and measurement, automotive, public works and defence.

The REP Series is available with the proven Hypertac® hyperboloid contact technology which ensures excellent reliability under shock and vibration, and allows up to 20,000 mating cycles and high current rating up to 18 A. REP connectors are also available in the EasyREP version, using MR screw machined contacts and allowing up to 500 mating cycles.

REP and EasyREP connectors are available in three layouts, with 2, 6, and 12 ways. Both versions are available with crimp termination contacts, for cable harness applications, and with straight or bent termination contacts for PCB mount applications. A shunt accessory is available for both versions, enabling derivation inside the connector for transmission of information to different locations.

Only one contact can be used for cross section cables 0.5 mm<sup>2</sup> to 2.5 mm<sup>2</sup> (20-13 AWG) according to NFF 63-808 and EN 50306 standards. No specific tool is required, with consequent reduction of supply chain, maintenance and cabling costs. Furthermore, for easy mounting, the connector includes polarised guides and provides several configurations: cable to cable, clips, front and back panel mount.

REP and EasyREP connectors are available for delivery as a complete, tested pre-cabled solution according to customers' specifications.

## Features

### Compact, flexible design

- Standard insulators available in 2, 6 and 12-way configurations
- Crimp, straight and bent termination options

### Easy mounting and maintenance

- No specific tooling required for mounting
- One contact required for cross-section cables 0.50-2.50 mm<sup>2</sup> (20-13 AWG) to NFF 63-808 and EN 50-306 standards

### High quality, integrated features

- Overmoulded silicone grommet and interfacial seal delivers IP66 and IP67 protection
- Vibration resistance to EN 61-373, Category 2 standards
- Compliance to fire and smoke standards
- Improved polarised guides
- Three coding devices: cable-to-cable, clip locking, and front and back panel mount

### Contact technologies

- Low insertion/extraction forces
- Minimal contact resistance
- Stable signal integrity

## Benefits

### Optimised for rail and embedded applications

- Space and weight savings
- Qualified to ensure high degree of safety
- Able to accept a large panel of cables with standard offering

### Fast and reliable connection

- Ensure failure-free performance in extremely demanding environments
- Immunity to fretting caused by mating/unmating and shock and vibration

### Reduced cost of ownership

- Minimised supply chain, inventory and maintenance costs
- Lowered cabling costs

### Superior performance

- Hypertac® and MR contacts ensure higher current carrying capacity than contacts of the same size

### Complete, tested pre-cabled solutions available to customer's exact specifications

# Available Contact Technologies

## Features and Benefits

### Hypertac® Hyperboloid - Original HC

**Long contact life**

Industry-leading mating cycles (up to 20,000) provide low cost of ownership

**Superior signal integrity**

No discontinuity when measured down to 2ns

**Low insertion/extraction forces**

Ergonomic mating without cost and size of mate assist hardware

**Lower contact resistance**

Low power consumption / lower voltage drop across connector

**Higher current ratings**

Smaller contacts needed to carry power for reduced size and weight

**Immunity to shock and vibration**

Reliability under harsh environmental conditions

**360° contact wipe**

Self-cleaning contacts assure uninterrupted connection

**Cable section**

From 0.5 to 2.5 mm<sup>2</sup> cross section (20-13 AWG)

**RoHS compliance**

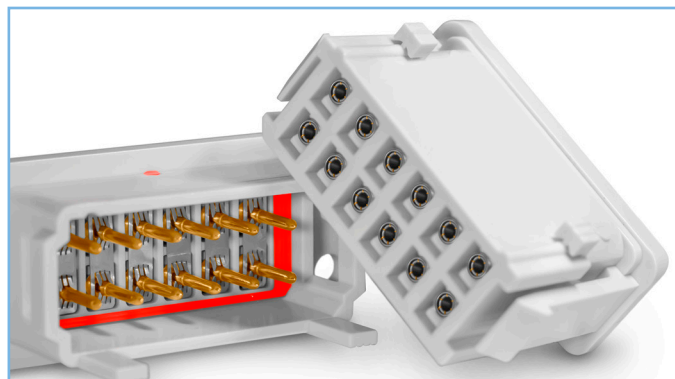
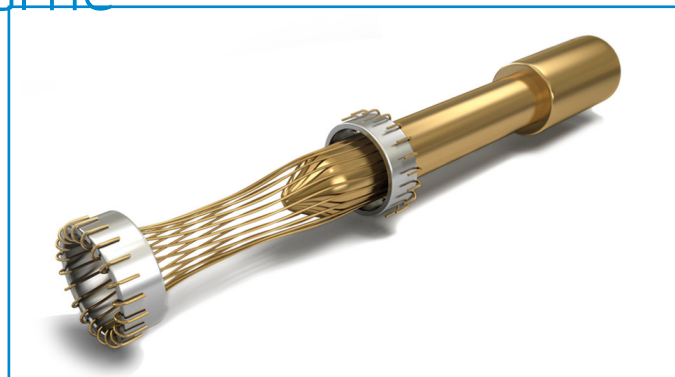

### Screw-machined contact - MR

**Rail standard contact life**

Mechanical life >500 cycles

**Tested signal integrity**

No contact interruption >50 ns

**Flexible design**

The inner clip and the socket body are manufactured and plated separately

**Reliable and cost effective**

The production of machined specific contact bodies allows for high volume

**Low insertion/extraction forces**

Ergonomic mating without cost and size of mate assist hardware

**Low contact resistance**

Low power consumption / lower voltage drop across connector

**Higher current ratings**

Small contacts needed to carry power for reduced size and weight

**Cable section**

From 0.75 to 2.5 mm<sup>2</sup> cross section (18-13 AWG)

**RoHS compliance**



# Technical Characteristics

## STANDARDS

<b>Contact Arrangements</b> <b>Contact Diameter</b> <b>Weight</b> (contacts included)	2, 6, 12 Size 16: Ø 1.50 mm (0.059 in) REP102 with contacts: 7.74g REP202 with contacts: 8.18g REP402 with bent contacts: 9g REP402 with straight contacts: 8g REP506 with contacts: 17.9g REP606 with contacts: 19.3g REP406 with bent contacts: 15.5g REP406 with straight contacts: 13.5g REP512 with contacts: 32.8g REP612 with contacts: 33.9g REP412 with bent contacts: 25g REP412 with straight contacts: 22g	
<b>Coding Configurations</b> <b>Polarisation</b>	Cable-to-cable, clip locking, panel mount 180°	

## Materials & Plating

<b>Contacts</b> <b>Insulator</b> <b>Seal &amp; Grommet</b>	Gold over nickel plating Polycarbonate Overmoulded silicone	
--	---	--

## Mechanical & Environmental

<b>Contact Retention Force</b> <b>Contact Retention Force PCB version</b> <b>Clip Locking Retention Force</b> <b>Mating Cycles</b> <b>Temperature Range</b>	> 70 N > 20 N >110 N > 500 cycles -75 °C to +100 °C (for crimp versions) -40 °C to +250 °C (for receptacles REP4xx)	– – – – –
<b>Vibration</b> <b>Flammability</b>	Category 2 (bogie installation) I2 F1 Condition 4 HL3 for R22 30s Category 2	EN 61373 NF F 16-101 NF F 16-102 EN 45545-2 EN ISO 11925-2
<b>Salt Spray</b> <b>Fluid Resistance</b> <b>IP Level</b>	V-0 > 96 hours Cleaning substances, gasoline/oil, acids, IP66, IP67	UNI CEI 11170-3 UL94 ASTM-B-117 EN 60529

## Electrical

<b>Current Rating</b> <b>Voltage Rating</b> <b>Dielectric Withstanding Voltage</b> <b>Contact Resistance</b> <b>Insulation Resistance</b>	18 A 230 V (400 V with plastic dummy contacts) 2725 V $\leq 2.5 \text{ m}\Omega$ $\geq 5 \times 10^3 \text{ M}\Omega$	– EN 50124-1, pollution degree 3 EN 50124-1 – –
---	---	---

# Dimensions 2,6,12-Way Connectors

## 2 Way Plugs & Receptacles

Cable Harness, Crimp Termination

### Female plug

P/N: REP-102-XX-2X-XX

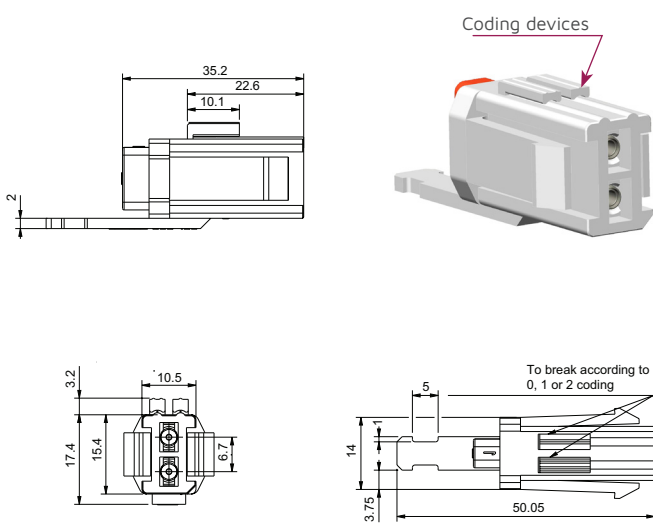

### Male receptacle

P/N: REP-202-XX-20-XX

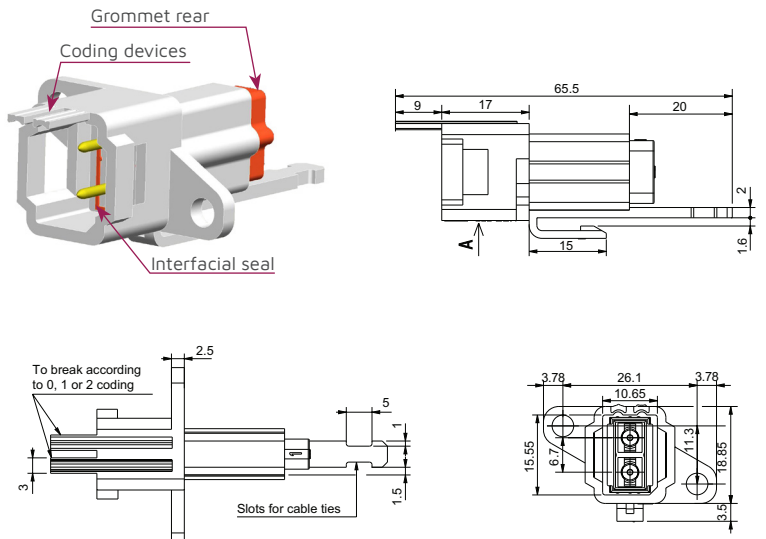

## 2 Way Receptacles

PCB/Panel Mount, Straight & Bent Termination

### Straight male receptacle

P/N: REP-402-XX-30-XX

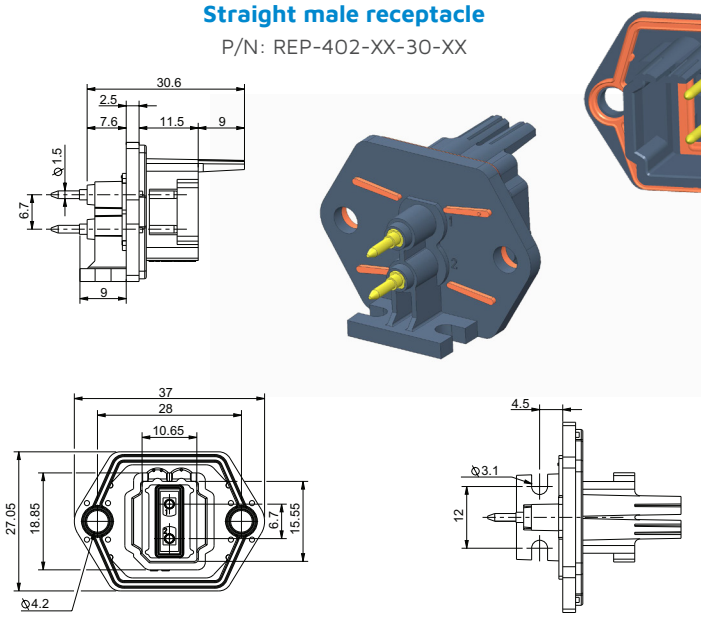

### Bent male receptacle

P/N: REP-402-XX-10-XX

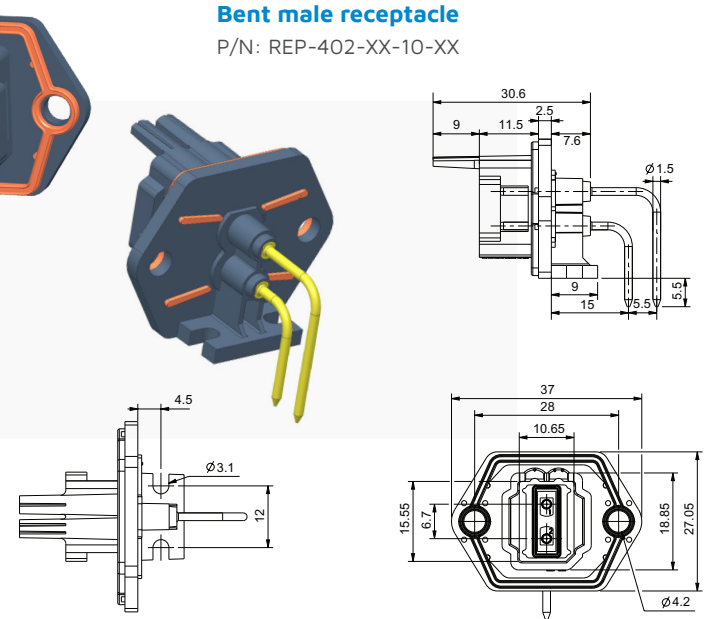

# 6 Way Plugs & Receptacles

## Female plug

P/N: REP-506-XX-2X-XX

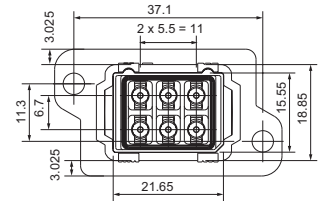
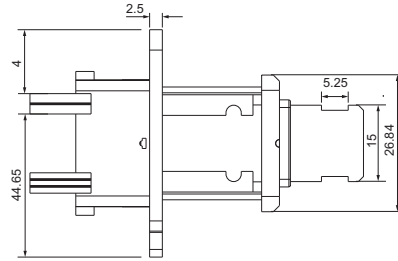
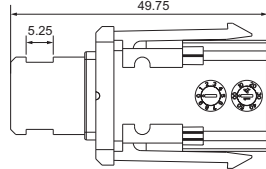
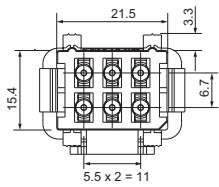
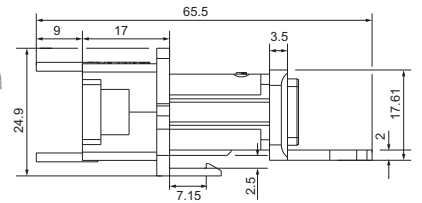
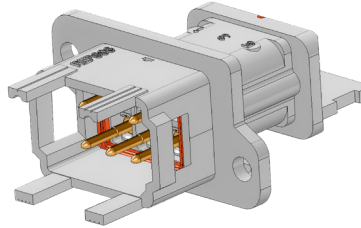
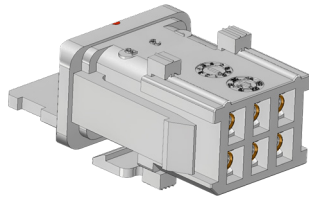
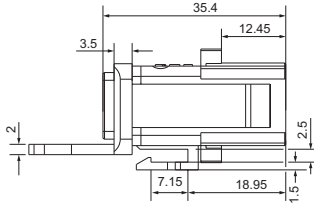

# 6 Way Receptacles

## PCB/Panel Mount, Straight & Bent Termination

### Straight male receptacle

P/N: REP-406-XX-30-XX

### Bent male receptacle

P/N: REP-406-XX-10-XX

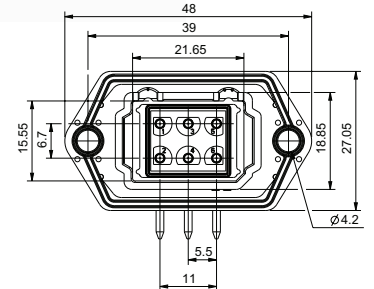
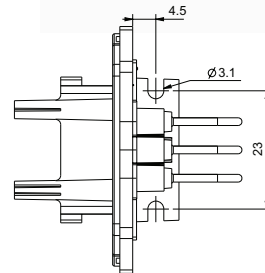
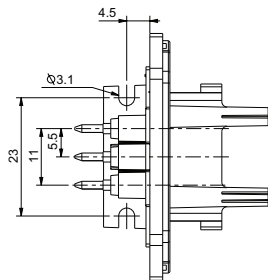
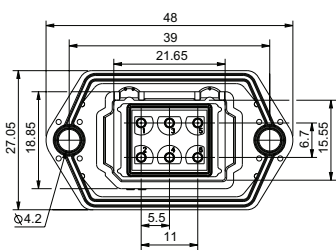
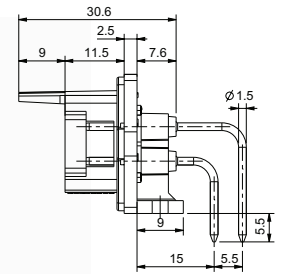
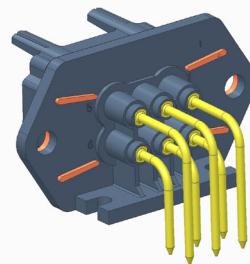
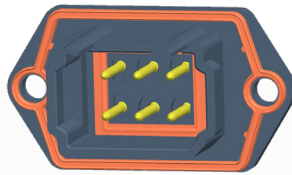
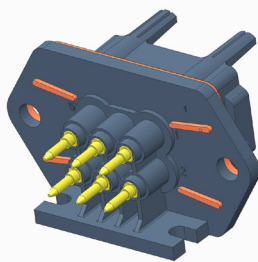
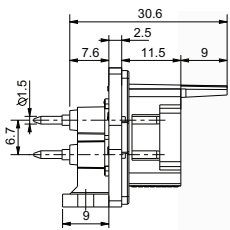



## 12 Way Plugs & Receptacles

Cable Harness, Crimp Termination

### Female plug

P/N: REP-512-XX-2X-XX

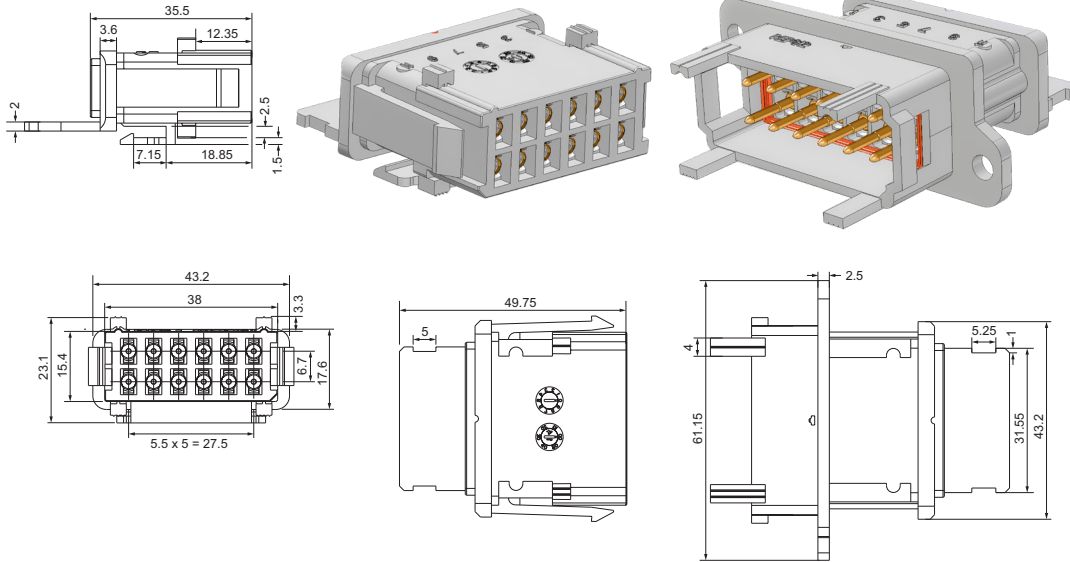

### Male receptacle

P/N: REP-612-XX-20-XX

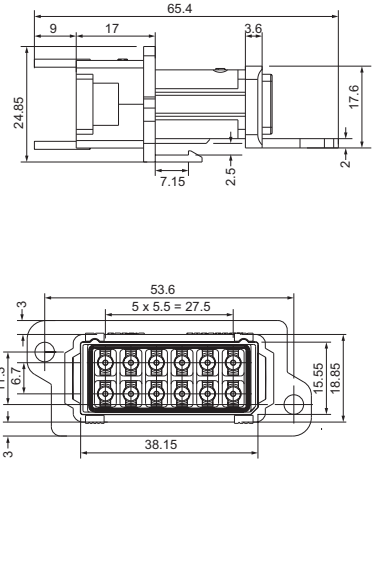

## 12 Way Receptacles

PCB/Panel Mount, Straight & Bent Termination

### Straight male receptacle

P/N: REP-412-XX-30-XX

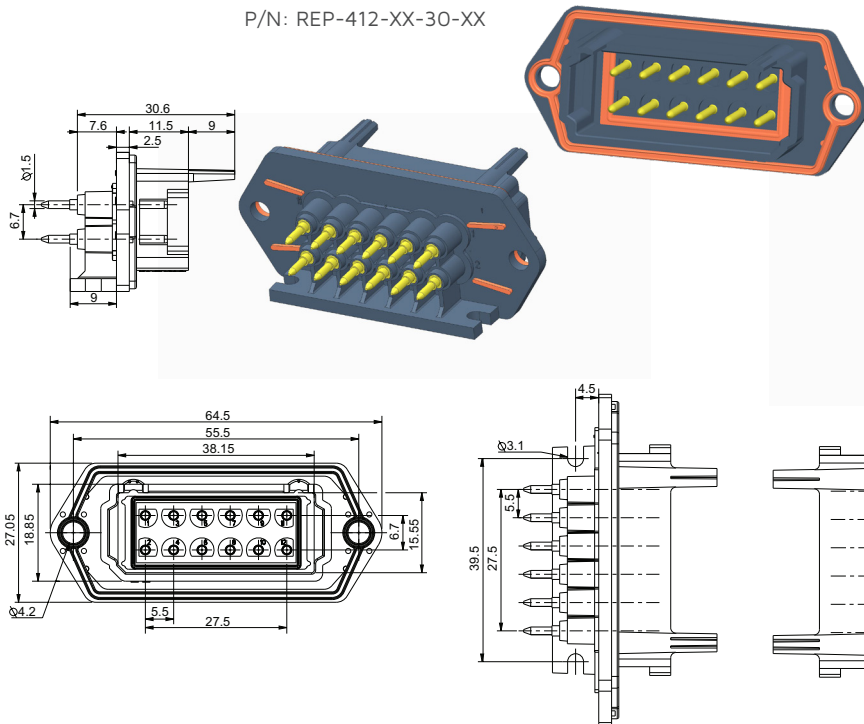

### Bent male receptacle

P/N: REP-412-XX-10-XX

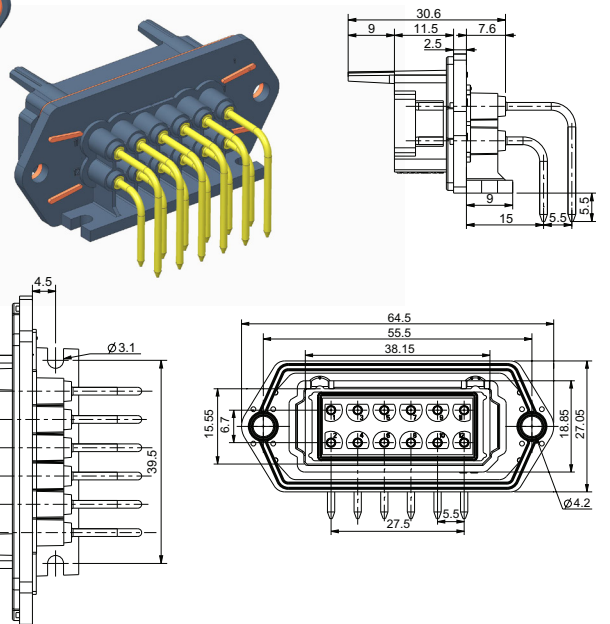



# Assembly Contacts & Accessories

## Contact & Shunt Assembly

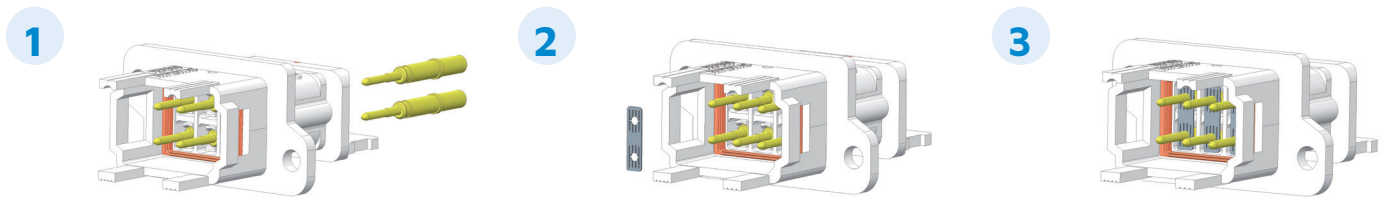
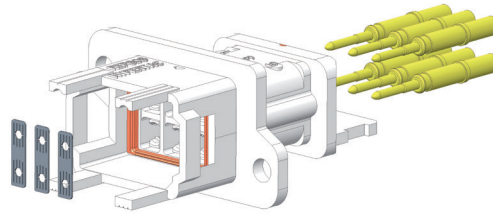









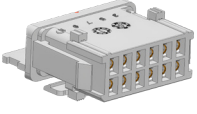
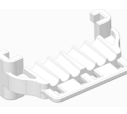

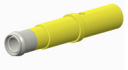
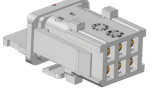

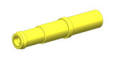
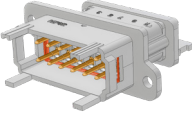

Contact insertion

Shunt installation

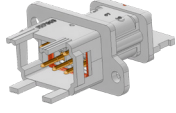
Installation complete

## Accessories

CONNECTOR	Cable Retainer	Panel Seal	Panel Mount Bracket	Dummy Contacts <sup>(1)</sup>	Filler Plug	CONTACTS	Crimping Tool	Locator	Selector Positions Wire Cross Sections
 <b>Female plug, 12-way</b> REP 512	 REP 007-12		 REP 003-12			 0151832-20-N1	Astro-tool TGV 101	TGV 202 rouge	Position 5: AWG 20-17 Only for 0151832-20-N1  Position 5: AWG 18-17 Only for 850-1018772-000
 <b>Female plug, 6-way</b> REP 506	 REP 007-06		 REP 003-06			 850-1018772-000	Daniels FT8	SH 463 rouge	Position 6: AWG 16-15  Position 7: AWG 14-13  Extraction Tool SD-0150000012
 <b>Male receptacle, 12-way</b> REP 612	 REP 007-12	 REP 006-12	 REP 003-12	 REP 002	 REP 001	 0151081-20-1G	Astro-tool TGV 101	TGV 202 rouge	Position 5: AWG 20-18  Position 6: AWG 16-14  Position 7: AWG 13
 <b>Male receptacle, 6-way</b> REP 606	 REP 007-06	 REP 006-06	 REP 003-06			 REP 901	Daniels FT8	SH 463 rouge	Extraction Tool SD-0150000012 (contacts)  Insert Tool S_147 (Shunt REP 901)

(1) Use up to 400 V

Dimensions are in mm | All specifications are subject to change without notice

# How To Order



REP

■ ■ ■

■ ■

■ ■

■ ■

1

2

3

4

5

<b>1 Series</b>	REP Series [fixed]												
<b>2 Layout</b>	<table border="0"> <tr> <td>1 0 2 Plug - 2 socket contacts</td> <td>2 0 2 Receptacle - 2 pin contacts</td> </tr> <tr> <td>4 0 2 Receptacle for pcb or panel mount - 2 pin contacts</td> <td></td> </tr> <tr> <td>4 0 6 Receptacle for pcb or panel mount - 6 pin contacts</td> <td></td> </tr> <tr> <td>4 1 2 Receptacle for pcb or panel mount - 12 pin contacts</td> <td></td> </tr> <tr> <td>5 0 6 Plug - 6 socket contacts</td> <td>5 1 2 Plug - 12 socket contacts</td> </tr> <tr> <td>6 0 6 Receptacle - 6 pin contacts</td> <td>6 1 2 Receptacle - 12 pin contacts</td> </tr> </table>	1 0 2 Plug - 2 socket contacts	2 0 2 Receptacle - 2 pin contacts	4 0 2 Receptacle for pcb or panel mount - 2 pin contacts		4 0 6 Receptacle for pcb or panel mount - 6 pin contacts		4 1 2 Receptacle for pcb or panel mount - 12 pin contacts		5 0 6 Plug - 6 socket contacts	5 1 2 Plug - 12 socket contacts	6 0 6 Receptacle - 6 pin contacts	6 1 2 Receptacle - 12 pin contacts
1 0 2 Plug - 2 socket contacts	2 0 2 Receptacle - 2 pin contacts												
4 0 2 Receptacle for pcb or panel mount - 2 pin contacts													
4 0 6 Receptacle for pcb or panel mount - 6 pin contacts													
4 1 2 Receptacle for pcb or panel mount - 12 pin contacts													
5 0 6 Plug - 6 socket contacts	5 1 2 Plug - 12 socket contacts												
6 0 6 Receptacle - 6 pin contacts	6 1 2 Receptacle - 12 pin contacts												
<b>3 Part - Polarity</b>	<table border="0"> <tr> <td>0 3 Plug without contact</td> <td>0 4 Receptacle without contact</td> </tr> <tr> <td>1 2 Female plug with Hyperboloid contacts*</td> <td>2 3 Male receptacle with contacts</td> </tr> <tr> <td>1 M Female plug with MR contacts**</td> <td>2 7 Male receptacle with tinned contacts</td> </tr> <tr> <td></td> <td>2 B Male receptacle with RoHS tinned contacts</td> </tr> </table>	0 3 Plug without contact	0 4 Receptacle without contact	1 2 Female plug with Hyperboloid contacts*	2 3 Male receptacle with contacts	1 M Female plug with MR contacts**	2 7 Male receptacle with tinned contacts		2 B Male receptacle with RoHS tinned contacts				
0 3 Plug without contact	0 4 Receptacle without contact												
1 2 Female plug with Hyperboloid contacts*	2 3 Male receptacle with contacts												
1 M Female plug with MR contacts**	2 7 Male receptacle with tinned contacts												
	2 B Male receptacle with RoHS tinned contacts												
<b>4 Termination Style</b>	<table border="0"> <tr> <td>0 0 Without contact</td> </tr> <tr> <td>1 0 Bent termination contact for REP 402, 406 and 412</td> </tr> <tr> <td>2 0 Crimp contact 20-13 AWG for REP 102, 506, 512, 202, 606 and 612 (Pin and Hyperboloid Contact only)</td> </tr> <tr> <td>2 1 Crimp contact 18-13 AWG for REP 102, 506, 512 (MR Contact only)</td> </tr> <tr> <td>3 0 Straight termination contact for REP 402, 406 and 412</td> </tr> </table>	0 0 Without contact	1 0 Bent termination contact for REP 402, 406 and 412	2 0 Crimp contact 20-13 AWG for REP 102, 506, 512, 202, 606 and 612 (Pin and Hyperboloid Contact only)	2 1 Crimp contact 18-13 AWG for REP 102, 506, 512 (MR Contact only)	3 0 Straight termination contact for REP 402, 406 and 412							
0 0 Without contact													
1 0 Bent termination contact for REP 402, 406 and 412													
2 0 Crimp contact 20-13 AWG for REP 102, 506, 512, 202, 606 and 612 (Pin and Hyperboloid Contact only)													
2 1 Crimp contact 18-13 AWG for REP 102, 506, 512 (MR Contact only)													
3 0 Straight termination contact for REP 402, 406 and 412													
<b>5 Accessories</b>	<table border="0"> <tr> <td>0 0 Without accessory</td> </tr> <tr> <td>0 1 Filler plug for REP 102, 506, 512, 202, 606 and 612</td> </tr> <tr> <td>0 2 Plastic dummy contact for REP 102, 506, 512, 202, 606 and 612</td> </tr> <tr> <td>0 3 Bracket for panel mounting for REP 202, 606 and 612</td> </tr> <tr> <td>0 4 Spacer for straight termination contact for REP 402, 406 and 412</td> </tr> <tr> <td>0 7 With accessory for cable retainer for REP 506, 512, 606 and 612</td> </tr> <tr> <td>0 9 With shunts for REP 606 and 612</td> </tr> <tr> <td>1 0 With panel seal for REP 606 and 612</td> </tr> </table>	0 0 Without accessory	0 1 Filler plug for REP 102, 506, 512, 202, 606 and 612	0 2 Plastic dummy contact for REP 102, 506, 512, 202, 606 and 612	0 3 Bracket for panel mounting for REP 202, 606 and 612	0 4 Spacer for straight termination contact for REP 402, 406 and 412	0 7 With accessory for cable retainer for REP 506, 512, 606 and 612	0 9 With shunts for REP 606 and 612	1 0 With panel seal for REP 606 and 612				
0 0 Without accessory													
0 1 Filler plug for REP 102, 506, 512, 202, 606 and 612													
0 2 Plastic dummy contact for REP 102, 506, 512, 202, 606 and 612													
0 3 Bracket for panel mounting for REP 202, 606 and 612													
0 4 Spacer for straight termination contact for REP 402, 406 and 412													
0 7 With accessory for cable retainer for REP 506, 512, 606 and 612													
0 9 With shunts for REP 606 and 612													
1 0 With panel seal for REP 606 and 612													

# You may also be interested in



## Compact Signal and Ethernet PCB Connectors

Compact, high-speed, and reliable solution for PCB to PCB and floating mounting rack and panel applications  
 Hyperboloid contact technology for signal and high speed quadrx 100 Ohm contacts  
 Compliance with the main European Railway standards (EN45545-2, NF F61030, EN50155:2017, STM-S-001ind.D & more), with MIL-C-28748 and MIL-STD-202-301 standards and EIA/IEC standards for contact resistance and environmental testing

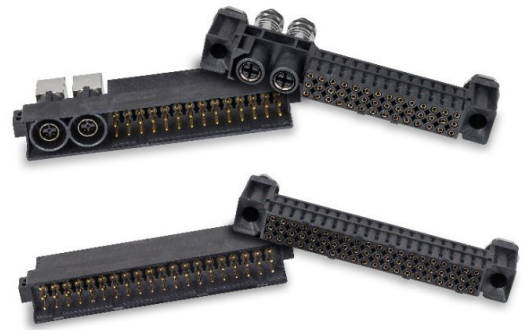

## Modular and Mini-Modular Connectors

Mixed signal, power, coaxial, fiber optic and pneumatic modules  
 Provides up to 200 amp power  
 Cable to chassis and rack & panel; Plastic backshell with strain relief and half turn quick disconnect jackscrew  
 Float mountable for blind mating  
 Configurations compliant to EN45545 standards  
 Hyperboloid contact technology



## Rugged M12 Connectors

Compact IP67 metal shell  
 360° EMI shielding  
 Hyperboloid contact technology  
 Compliant with rail fire and smoke standards  
 Straight and right angle 90° rotatable backshell  
 Compatible with most commonly used rail cables



# Worldwide Support

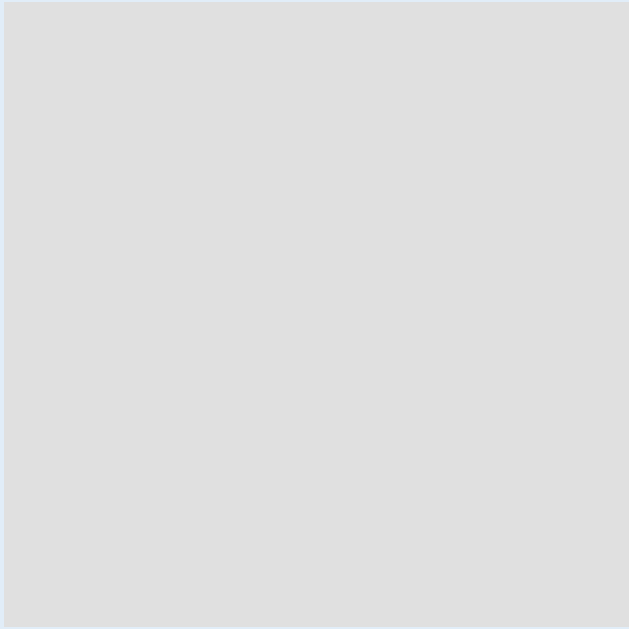

## Fibre Optics & RF Components

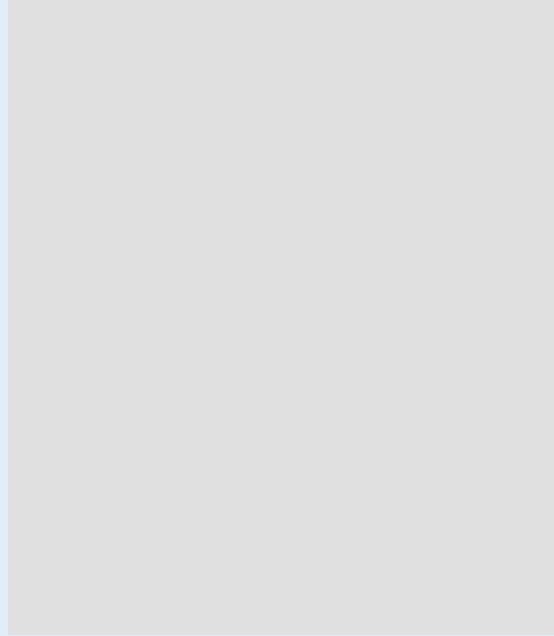
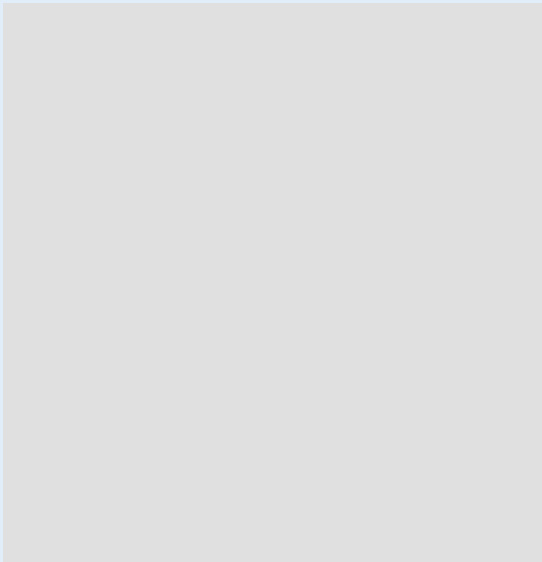

## RF/MW Subsystems

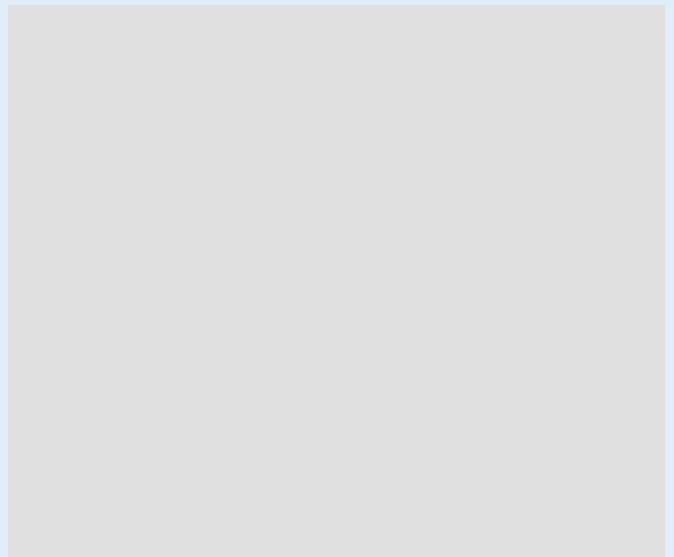

more > [smithsinterconnect.com](https://smithsinterconnect.com) | [in](#) [X](#) [▶](#)

Copyright© 2023 Smiths Interconnect | All rights reserved | Version 3.0

The information contained within this document is subject at all times to applicable Export Control regulations and legal requirements.