

FEATURES

- Excellent resistance to corrosive media (stainless steel barrel and rod)
- Mountings integrated in the front and MP4 cap in the rear cover for trunnion mounting
- Compact threaded mount for direct attachment of front or rear covers on machine
- Double acting cylinders with or without pneumatic cushioning

GENERAL

Detection	Equipped for magnetic position detectors
Fluid	Air or inert gas, filtered, lubricated or not
Operating pressure	[1 bar = 100 kPa]
single acting	2 to 10 bar
double acting	10 bar, max.
Ambient temperature	-10°C to +70°C
Optimal max. speed	≤ 1 m/s (for optimal service life)
Max. speed rate	2 m/s
Standards	ISO 6432



B

CONSTRUCTION

Barrel	Non-magnetic stainless steel
Rod	Stainless steel
Front and rear ends	Anodised light alloy (stainless steel: SSC option)
Cushioning seals	PUR (polyurethane)
Cushioning ^(a)	Pneumatic, adjustable from both sides with captive screw
Rod nut / neck nut	Galvanised steel
Piston	Light alloy POM (polyacetal) fitted with an annular permanent magnet
Piston seals	PUR (polyurethane)
Dismounting	Cannot be dismounted

Double acting ^(a) cushioning length
Ø 16 mm = 12,5 mm
Ø 20 mm = 17,5 mm
Ø 25 mm = 18 mm

^(a) CSH option

2D/3D CAD models - *In 3D*

HOW TO ORDER

15-DIGIT PRODUCT CODE

G 435 A - S N - - - - A00

Thread connection
G = ISO 16030

Product series
435

Revision letter
A = Initial release

Diameter (mm)
G = 8 K = 16
H = 10 L = 20
J = 12 M = 25

Rod options 1
S = Double acting
1 = Single acting rod in
2 = Through rod (double acting)
3 = Single acting rod out ⁽¹⁾

⁽¹⁾ Available in bore size: 12, 16, 20 and 25
All cylinders delivered with rod nut.

Rod options 2
N = Stainless steel male thread rod end + rod nut

Options

- A00** = Not cushioned piston, prepared for magnetic detection
- CSH** = Pneumatic cushioned piston, prepared for magnetic detection ⁽²⁾
- SSC** = Stainless Steel Covers, FPM Rod Seal, Prepared for Magnetic Detection, Not Cushioned ⁽³⁾
- AT1** = Cushioned and non cushioned piston, prepared for magnetic detection, certified for ATEX 1/21 zones
- AT2** = Cushioned and non cushioned piston, prepared for magnetic detection, certified for ATEX 2/22 zones

⁽²⁾ Available in bore size: 16, 20 and 25 (double acting only)

⁽³⁾ Available in bore size: 12, 16, 20 and 25 (double acting only) delivered with SS rod nuts

Recommended standard strokes (mm) ⁽⁴⁾

Ø mm	connect. Ø	25	50	80	100	160	max. stroke
8	M5	SD	SD	D	D		400
10	M5	SD	SD	D	D		400
12	M5	SDO	SDO	D	D		400
16	M5	SDO	SDO	D	D		400
20	G1/8	SDO	SDO	D	D		400
25	G1/8	SDO	SDO	D	D	D	900

Strokes range available up to "max. stroke" column on the right. Please note strokes marked in grey exceed the maximum recommended.

⁽⁴⁾ Other strokes on request. / Min. stroke: 5 mm

D = Double acting only / SD = Single & Double acting



SDO = Single acting rod in + Single acting rod out + Double acting



POSITION DETECTORS

Magnetic position detectors must be ordered separately: "T" model (see page P291), reed switch or magneto-resistive type

INSTALLATION

- The cylinders can be mounted in any position without affecting operation
- Each cylinder is delivered with a neck nut and a rod nut
- Mountings: **catalogue number**

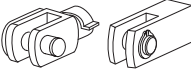
Ø (mm)	 Front or rear flange MF8		 High foot (per unit) MS3		 Rear trunnion	
	steel	st. steel	steel	st. steel	steel	st. steel
8 - 10	P493AG42A000A00	-	P493AG425000A00	-	P493AG42C000A00	-
12 - 16	P493AJ42A000A00	P493AJ42A200A00	P493AJ425000A00	P493AJ425200A00	P493AJ42C000A00	P493AJ42C200A00
20	P493AL42A000A00	P493AL42A200A00	P493AL425000A00	P493AL425200A00	P493AL42C000A00	P493AL42C200A00
25	P493AL42A000A00	P493AL42A200A00	P493AL425000A00	P493AL425200A00	P493AL42C000A00	P493AL42C200A00

Ø (mm)	 female rod clevis ISO 8140 - RP 102 P AP2		 spherical rod end ISO 8139 - RP 103 P AP6		 front neck nut MR3	
	steel	st. steel	steel	steel	steel	st. steel
8 - 10	P493AG431000A00	-	P493AG432000A00	-	P493AG42F000A00	-
12 - 16	P493AJ431000A00	P493AJ431200A00	P493AJ432000A00	-	P493AJ42F000A00	P493AJ42F200A00
20	P493AL431000A00	P493AL431200A00	P493AL432000A00	-	P493AL42F000A00	P493AL42F200A00
25	P493A3131000A00	P493AM431200A00	P493A3132000A00	-	P493AL42F000A00	P493AL42F200A00

- Pipe connections G 1/8 have standard thread according to ISO 16030
- Installation/maintenance instructions are included with each cylinder

DIMENSIONS (mm), WEIGHT (kg)



SINGLE-ROD TYPE CYLINDER
Bare cylinder, single and double acting
Supplied with front cover nut
ISO 6432



THROUGH-ROD TYPE CYLINDER
Bare cylinder, double acting
Supplied with front cover nut
ISO 6432

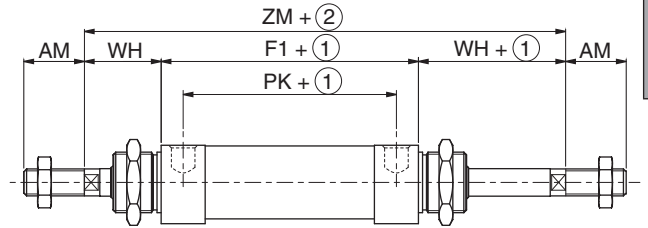
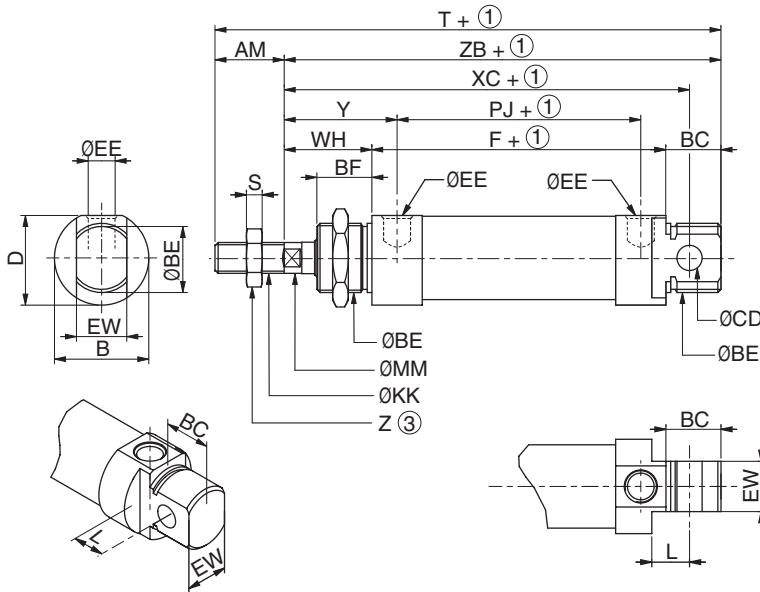

- ① Stroke
- ② Stroke x 2
- ③ Width across flats

Ø	AM	B	BC	ØBE	BF	ØCD	D	ØEE	EW	F	F1	ØKK	L	MM	PJ	PK	S	T	WH	XC	Y
8	12	16	12	M12x1,25	12	4 H 9	15	M5	8 d 13	46	-	M4x0,7	6	4	34	-	2	86	16	64	22
10	12	16	12	M12x1,25	12	4 H 9	15	M5	8 d 13	46	-	M4x0,7	6	4	34	-	2	86	16	64	22
12	16	19	14	M16x1,5	14	6 H 11	18	M5	12 d 11	48,5	48,5	M6x1	9	6	34,5	34,5	3	100,3	22	75	29
16	16	19	14	M16x1,5	14	6 H 11	18	M5	12 d 11	55	55	M6x1	9	6	41,5	41,5	3	107	22	82	28,5
20	20	27	17,5	M22x1,5	17,5	8 H 11	25,4	G 1/8	16 d 11	63,5	63,5	M8x1,25	12	8	47,3	47,3	4	125	24	95	32
25	22	30	17,5	M22x1,5	17,5	8 H 11	28,5	G 1/8	16 d 11	68,5	68,5	M10x1,25	12	10	52,5	52,5	5	136	28	104	36

Ø	Z	ZB	ZM	weight	
				(4)	(5)
8	7	74	-	0,030	0,020
10	7	74	-	0,030	0,040
12	10	84,5	82,5	0,070	0,090
16	10	91	99	0,100	0,100
20	13	105	111,5	0,170	0,160
25	17	114	124,5	0,200	0,200

(4) Cylinder weight at 0 mm stroke.
(5) Weight to be added per additional 100 mm length.

NOTE:
- Single and double acting cylinders Ø 8 to 25 mm have the same dimensions.
- The length of the single acting rod in version is twice the nominal stroke.
- The mountings are always delivered separately

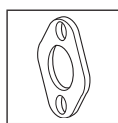

MOUNTING
Front or rear flange
MF8

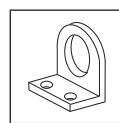

MOUNTING
High foot
Foot mounting are supplied in single units,
not in pairs
MS3

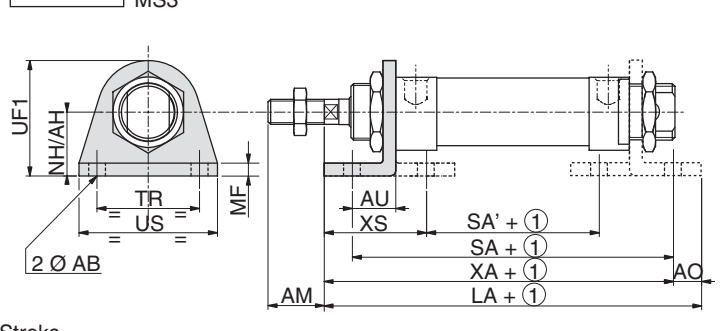
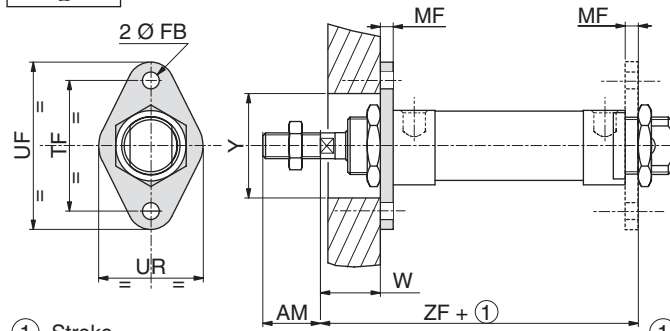

Ø (mm)	AM	ZF	MF	Y	W	ØFB	UF	TF	UR	weight
08	12	65	3	22	13	4,5	40	30	22	0,020
10	12	65	3	22	13	4,5	40	30	22	0,020
12	16	74,5	4	22	18	5,5	52	40	30	0,020
16	16	81,0	4	22	18	5,5	52	40	30	0,020
20	20	92,5	5	31	19	6,6	64	50	40	0,040
25	22	101,5	5	31	23	6,6	64	50	40	0,040

Ø (mm)	UF1	NH/AH	TR	US	MF	ØAB	AM	AU	XS	SA	SA'	XA	LA	AO	weight
08	26	16	25	35	3	4,5	12	11	24	68	30	73	78	5	0,030
10	26	16	25	35	3	4,5	12	11	24	68	30	73	78	5	0,030
12	32	20	32	42	4	5,5	16	14	32	76,5	28,5	84,5	90,5	6	0,050
16	32	20	32	42	4	5,5	16	14	32	83	35	91	97	6	0,050
20	45	25	40	54	5	6,6	20	17	36	97,5	39,5	104,5	113,5	9	0,100
25	45	25	40	54	5	6,6	22	17	40	102,5	44,5	113,5	122,5	9	0,100

01426GB-2013/R01
Availability, design and specifications are subject to change without notice. All rights reserved.

B

DIMENSIONS (mm), WEIGHT (kg)

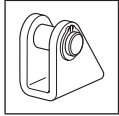

MOUNTING
Rear trunnion

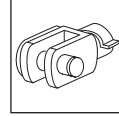

MOUNTING
Female rod clevis
ISO 8140
AP2 (steel)

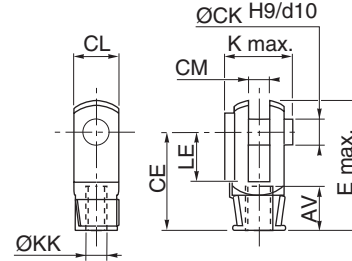
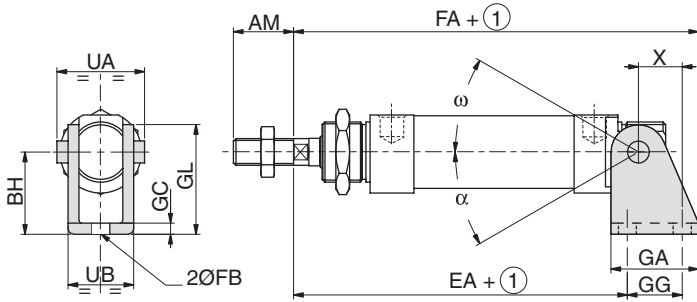

① Stroke

Ø (mm)	AM	BH	EA	FA	FB	GA	GC	GG	GL	UA	UB	X	α	ω	weight
8-10	12	24	62,7	79	4,5	20	2,5	12,5	29	18	13	11,2	7°	160°	0,020
12	16	27	72,5	93	5,5	25	3	16	34	25	18	13,5	50°	180°	0,050
16	16	27	79,5	100	5,5	25	3	16	34	25	18	13,5	47°	180°	0,050
20	20	30	91	117	6,6	32	4	20	40	32	24	16	8°	168°	0,080
25	20	30	100	126	6,6	32	4	20	40	32	24	16	8°	168°	0,080

Ø (mm)	Ø CK	CM	K	AV	LE	CE	CL	ØKK	E max.	weight
8-10	4	4 +0,04 -0,01	11	8	8	16	8	M4x0,7	22,5	0,010
12-16	6	6 +0,07 -0,01	16,5	12	12	24	12	M6x1	33,5	0,020
20	8	8 +0,10 -0,01	22	15	16	32	16	M8x1,25	45	0,050
25	10	10 +0,15 -0,01	26	20	20	40	20	M10x1,25	56	0,100

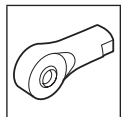

MOUNTING
Spherical rod end
ISO 8139
AP6 (steel)

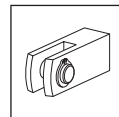

MOUNTING
Female rod clevis
ISO 8140
AP2 (stainless steel)

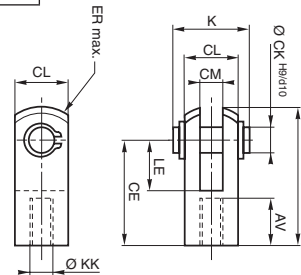
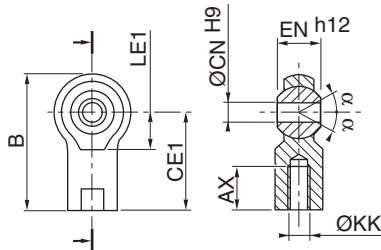

Ø (mm)	AX	B	CE1	ØCN	LE1	ØKK	EN	α	weight
8-10	8	36	27	5	10	M4x0,7	8	4°	0,020
12-16	12	40	30	6	11	M6x1	9	4°	0,030
20	15	48	36	8	13	M8x1,25	12	4°	0,050
25	20	57	43	10	15	M10x1,25	14	4°	0,070

Ø (mm)	CL max.	ØKK	CM	ØCN	E max.	AV min.	LE	CE	weight
8-10	8	M4x0,7	4	4	21	10	8	16	0,005
12-16	12	M6x1	6	6	31	12	12	24	0,015
20	16	M8x1,25	8	8	42	16	16	32	0,036
25	20	M10x1,25	10	10	52	20	20	40	0,075

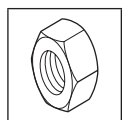

MOUNTING
Front neck nut
MR3

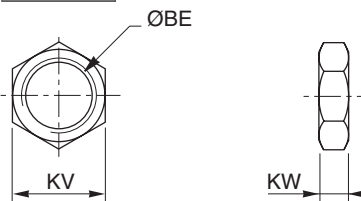

Ø (mm)	ØBE	KV	KW	weight
8	M12x1,25	19	6	0,010
10	M12x1,25	19	6	0,010
12	M16x1,5	19	4	0,010
16	M16x1,5	19	4	0,010
20	M22x1,5	27	5	0,010
25	M22x1,5	27	5	0,010