

CV3000 Series Model HCB

Pressure Balanced Cage type Control Valves

OVERVIEW

Model HCB Pressure Balanced Cage Type Control Valves are designed for heavy duty services. The compact valve body, having a S-shape flow passage that features low pressure loss and a stabilizer that regulates turbulent flow around the cage, allows a large flow capacity, rangeability, and high accuracy flow characteristics.

The valve plug is structured in a pressure-balanced type that permits flow control of a high differential pressure with a small actuating force. The actuator integrated with simplest mechanisms utilizes a compact yet powerful diaphragm actuator loaded with multiple springs.

The HCB valves are widely applicable for reliable control of high or low temperature, high pressure or high differential pressure process lines where dynamic stability, low noise, and cavitation/flashing resistance are required.

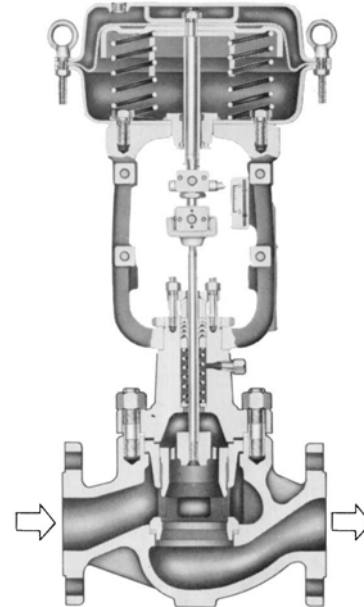

SPECIFICATIONS**Body****Type**

Straight-through type, Cast globe valve

Nominal size

1½, 2, 2½, 3, 4, 6, 8 in.

Pressure rating

- JIS 10K, 16K, 20K, 30K, 40K
- ANSI Class 125, 150, 300, 600
- JPI Class 125, 150, 300, 600

End connection

- Flanged end;
 - FF, RF, RJ, LG
 - Tongue and groove (groove)
 - Male and female (female)
- Welded end;
 - SW (1½, 2 in.)
 - BW (2½, 8 in.)

Material

For combining the valve body, trim materials and the operating temperature ranges, refer to Table 2.

Bonnet

- Plain bonnet (-17 to 230 °C)
- Extension bonnet Type 1 (-45 to -17 °C and 230 to 566 °C)
- Extension bonnet Type 2
 - Integral cast type (-100 to -45 °C)
 - Welded type (-196 to -100 °C)
- Bellow type
 - For operating temperature and pressure range, refer to Figure 3.

Note) Take care not to exceed the operating temperature ranges specified for respective materials.

Gland type

Bolted gland

Packing/grease

- Grease not provided; When V shaped PTFE packing or PTFE yarn packing is used.
- Grease provided; When asbestos yarn, PTFE-impregnated asbestos yarn, asbestos yarn with graphite, or graphite packing is used.

Gasket**Type;**

Combination of saw-tooth type and spiral type (integral cage),

Saw-tooth type (split cage)

Material;

Stainless steel (SUS316, SUS316L, SUS329J1), copper, aluminum

Trim**Valve plug**

Pressure balanced type

- High-capacity (For flow characteristics, refer to Figure 1.)
 - Metal seat;
 - Equal percentage cage (%V)
 - Linear cage (LV)
 - Soft seat;
 - Equal percentage cage (%T)
 - Linear cage (LT)
- High-flow characteristics type
 - Metal seat
 - (For flow characteristics, refer to Figure 2.)
 - Equal percentage cage (%VF)
 - Linear cage (LVF)
 - Soft seat
 - (For flow characteristics, refer to Figure 2.)
 - Equal percentage cage (%TF)
 - Linear cage (LTF)

Notes 1) Integral cage and split cage vary depending on their valve sizes, materials, and operating temperature. Refer to Table 2.

2) For operating temperature and max. differential pressure range of soft-seat type, refer to Figure 4.

Material

For combining the valve body, trim materials and the operating temperature ranges, refer to Table 2.

Note) For fluid conditions that require Stellite, refer to Figure 5.

Actuator**Type**

- Single acting diaphragm actuator (Type HA or VA5)
- Spring Type piston actuator (Type PSA6R)

Action

Direct or reverse action

Diaphragm

Type HA; Cloth embedded ethylene propylene rubber
Type VA; Cloth-embedded chloroprene rubber

Spring range

20 to 98 kPa {0.2 to 1.0 kgf/cm²},
40 to 120 kPa {0.4 to 1.2 kgf/cm²},
80 to 240 kPa {0.8 to 2.4 kgf/cm²}
(Type HA or VA5)
200 to 340kPa {2.0 to 3.5 kgf/cm²}
200 to 390kPa {2.0 to 4.0 kgf/cm²}
(Type PSA6R)

Supply pressure

Diaphragm actuator

Type HA 1.2 to 4.0 kgf/cm² {120 to 390 kPa}

Type VA5 1.2 to 2.8 kgf/cm² {120 to 270 kPa}

Spring Type Piston actuator

Type PSA6R 4 to 5kgf/cm² {400 to 500 kPa}

Note) Permissible differential pressure varies depending on spring range and air supply pressure.

Air connection

Rc $\frac{1}{4}$ or $\frac{1}{4}$ NPT internal thread

Note) With Type VA, Rc $\frac{1}{4}$ or $\frac{1}{4}$ NPT adapter is provided on Rc $\frac{1}{2}$ internal thread (also providing Rc $\frac{3}{8}$ adapter is possible).

Ambient temperature

-30 to 70 °C

Valve action

Direct action (Direct action actuator is combined.)

Reverse action (Reverse action actuator is combined.)

Optional accessories

Positioner*, pressure regulator with filter, manual operating device*, limit switch, solenoid valve, motion transmitter, volume booster, air lock relay, and others.

Notes : 1) For the optional items, refer to the specification sheets and installation drawings of respective accessories.

2) Accessories with the asterisk mark (*) are selected from among the following types depending on the actuators to be combined.

Table 1.

Actuator	Positioner		Manual handwheel	
	P/P	I/P	Top	Side
HA1	VPE	HEP/AVP	THM	—
HA2to4	HTP	HEP/AVP	THM	SHM
VA5	HTP	HEP/AVP	THM	SHM
PSA6	HTP/VPP	HEP/AVP	—	SHM

Additional specification (by special order)

Flow characteristics inspection, material inspection (Material certificate), non-destructive inspection, steam inspection, low-temperature inspection

- Seat chamfered flange
- With drain plug
- Double gland
- Oil/water free treatment
- Copper free treatment
- Stainless steel (SUS304) atmosphere-exposed nuts and bolts
- Special air piping and joint
- Sand-/dust-preventive measure
- Saline damage countermeasure
- Cold-area use specification
- Tropical-area use specification
- Vacuum service

Performance**Rated Cv value**

Refer to Table 3.

Flow characteristics

Refer to Figure 1 and 2.

Inherent rangeability

50 : 1

Permissible differential pressure

Refer to Table 5, 6, 7 and 8.

Seat leakage rate

IEC534-4-1982 or JIS B2007-1993

· Metal seat

Standard

Class II : Leakage less than 0.5% of maximum valve capacity.

Option

Class III : Leakage less than 0.1% of maximum valve capacity.

· Soft seat

Class VI : Leakage 0.00001% of maximum valve capacity.

Hysteresis error

Without positioner : Within 3% F.S. (Within 5% F.S.)

With positioner : Within 1% F.S.

Linearity

Without positioner : Within $\pm 5\%$ F.S.

With positioner:

Within $\pm 1\%$ F.S.

($\pm 3\%$ F.S. with Type VPE positioner, $\pm 2\%$ F.S. with Type HEP positioner)

Notes : 1) When positioner is not provided, operating performance may vary depending on type of packings used.

2) Parenthesized Figures are applicable to Type

HA1.

Face-face dimensions

Refer to Figure 6 and Table 9.

External dimensions

Refer to Figure 6 and Table 11.

Weight

Refer to Table 12.

Installation position

Refer to Figure 7.

Finish

Blue (Munsell color 10B5/10) or silver, or other specified colors.

Table 2. Combining the valve body, trim materials and operating temperature range (°C)

Body Material		JIS	FC200	SCPH2	SCPH21	SCPH61	SCPL1	SCS11	SCS13A	SCS14A	SCS16A	SCS19A
		ASTM	A126Gr.B	A216WCB	A217WC6	A217C5	A352LCB	—	A351CF8	A351CF8M	A351CF3M	A351CF3
JIS	SCS24		0 to 200	-5 to 425	-5 to 425	-5 to 425	-40 to 350	—	—	—	—	—
ASTM	CB7Cu-1											
JIS	SCS11		—	—	—	—	—	-50 to 300	—	-50 to 300	—	—
ASTM	—											
JIS	SCS14A		0 to 200	-5 to 300*	-5 to 300*	-5 to 300*	-45 to 300	—	-196 to 300	-196 to 300	—	—
ASTM	A351CF8M											
JIS	SCS16A		—	—	—	—	-45 to 300	—	-196 to 300	-196 to 300	-196 to 300	—
ASTM	A351CF3M											
JIS	SCS19A		—	—	—	—	-45 to 300	—	-196 to 300	-196 to 300	—	-196 to 300
ASTM	A351CF3											
JIS	SCS11 Stellite		—	—	—	—	—	-50 to 550	—	-50 to 550	—	—
ASTM	—											
JIS	SCS14A Stellite		—	-5 to 425*	-5 to 550*	-5 to 556*	-45 to 350	—	-196 to 550	-196 to 550	—	—
ASTM	A351CF8M Stellite											
JIS	SCS16A Stellite		—	—	—	—	-45 to 350	—	-196 to 450	-196 to 450	-196 to 450	—
ASTM	A351CF3M Stellite											
JIS	SCS19A Stellite		—	—	—	—	-45 to 350	—	-196 to 450	-196 to 450	—	-196 to 450
ASTM	A351CF3 Stellite											
JIS	SCS14A Atomroy		—	-5 to 425*	-5 to 500*	-5 to 500*	—	—	—	—	—	—
ASTM	A351CF8M Atomlloy											
JIS	SCS24 Soft seat		0 to 200	-5 to 200	—	—	-45 to 200	—	—	—	—	—
ASTM	CB7Cu-1 Soft seat											
JIS	SCS11 Soft seat		—	—	—	—	—	-50 to 200	—	-50 to 200	—	—
ASTM	—											
JIS	SCS14A Soft seat		0 to 200	-5 to 200	—	—	-45 to 200	—	-80 to 200	-80 to 200	—	—
ASTM	A351CF8M Soft seat											
JIS	SCS16A Soft seat		—	—	—	—	-45 to 200	—	-80 to 200	-80 to 200	-80 to 200	-80 to 200
ASTM	A351CF3M Soft seat											

Notes 1) Asterisk marked (*) combinations, split cages are used when fluid temperature exceeds 230 °C and valve size is greater than 3 in.
 2) "  " shows standard combination of valve body and trim materials.
 3) These complying ASTM Regulation show JIS equivalents.

Cv value and travel

Table 3. High-capacity type cage (%V, LV, %T, LT)

Nominal size (in.)		1½	2	2½	3	4	6	8
Port size (in.)		1½	2	2½	3	4	6	8
Rated Cv value	Metal or soft seat type Equal percentage characteristics(%V,%T)	36	60	100	140	220	420	820
	Metal or soft seat type Linear characteristics (LV, LT)	40	75	110	150	240	435	850
Rated travel (mm)		25		38		50	75	

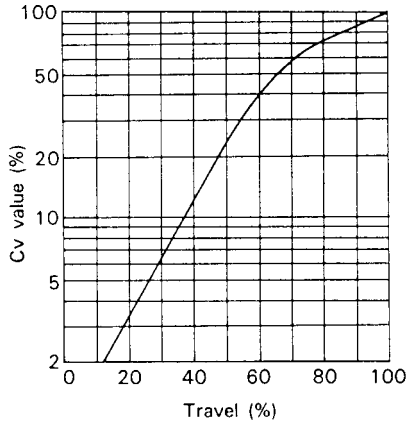

**a. Equal percentage characteristics
(%V metal seat, %T soft seat)**

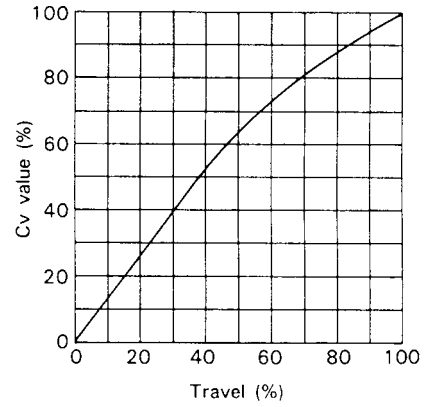

**b. Linear characteristics
(%LV metal seat, LT soft seat)**

Figure 1. High-capacity type

Table 4. High-flow characteristic type cage (%VF, LVF, %TF, LTF)

Nominal size (in.)	1½			2			2½			3			4			6			8		
Port size (in.)	1	1¼	1½	1¼	1½	2	1½	2	2½	2	2½	3	2½	3	4	4	5	6	5	6	8
Rated Cv value (%VF, LVF, %TF, LTF)	11	17	24	17	24	44	24	44	68	44	68	99	68	99	175	175	275	360	275	360	650
Rated travel (mm)	25						38						50			75					

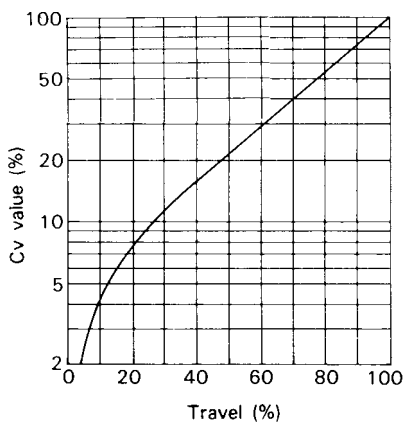

**a. Equal percentage characteristics
(%VF : metal seat)**

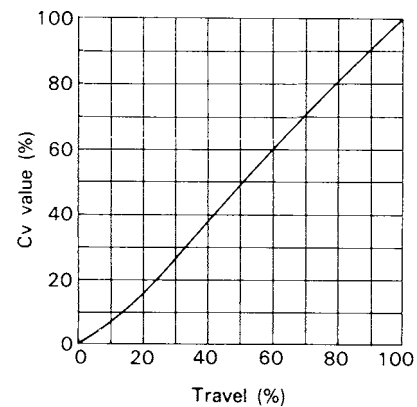

**b. Linear characteristics
(LVF : metal seat)**

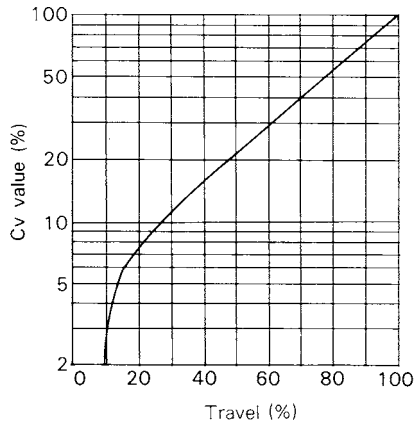

c. Equal percentage characteristics (%TF Soft seat)

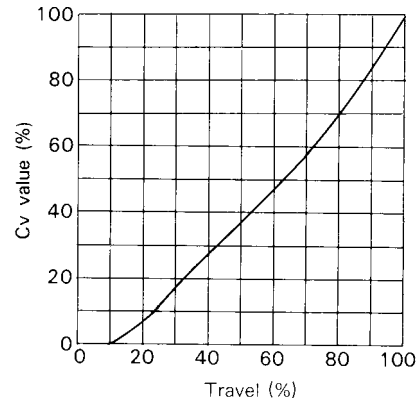

d. Linear characteristics (LTF Soft seat)

Figure 2. high-flow characteristics type cage
Flow characteristics

Note) The above graphs indicate typical flow characteristics.

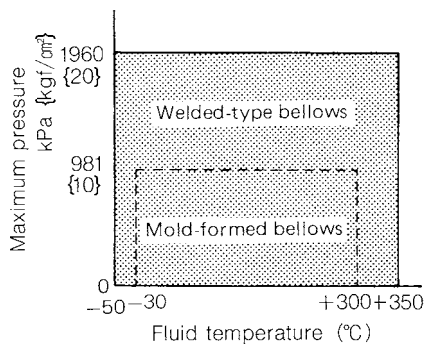

Figure 3. Operating temperature and pressure range of bellows type bonnet

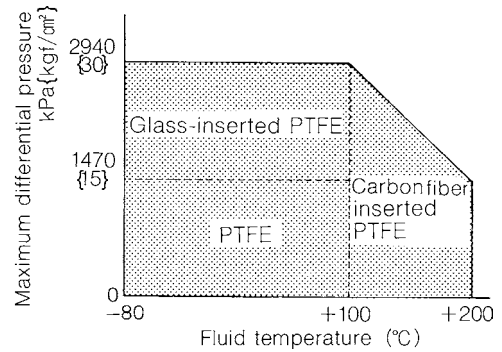

Figure 4. Operating temperature and maximum differential pressure range of soft-seat type

Note) If there is any possibility to cause erosion due to saturated steam or superheated-water, use the metal seat.

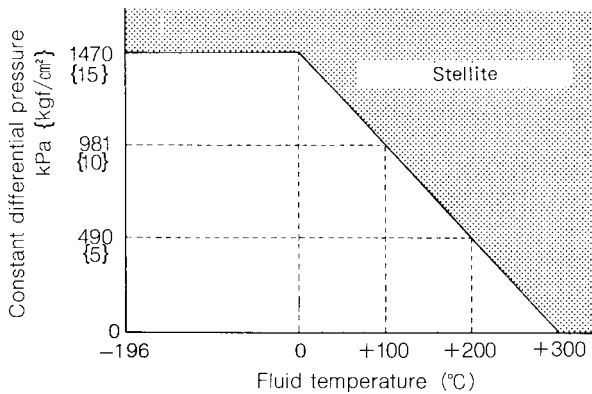

Figure 5. Temperature / constant differential pressure ranges requiring Stellite

- Note :
- 1) SCS24 (Precipitation-hardened stainless steel) requires no Stellite.
 - 2) For cavitation / flashing service or oil prohibited service, SCS24 or Stellite is recommended regardless of temperature and differential pressure.

Permissible differential pressure

Contoured-type metal seat (%VF, LVF, %V, LV)

Table 5. Direct action (Air-to-close)

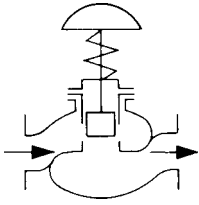

Actuator Model No.	Supply Pressure kgf/cm ² {kPa}	Spring Range kgf/cm ² {kPa}	Positioner	Differential pressure (by nominal size (in.)) kPa {kgf/cm ² }						
				1½	2	2½	3	4	6	8
HA1D	140 {1.4}	20 to 98 {0.2 to 1.0}	Δ	500 {5.1}	390 {4.0}	—	—	—	—	—
	160 {1.6}	20 to 98 {0.2 to 1.0}	✓	2450 {25.0}	1860 {19.0}	—	—	—	—	—
	390 {4.0}	20 to 98 {0.2 to 1.0}	✓	3920 {40.0} 7450 {76.0}	3920 {40.0} 5780 {59.0}	—	—	—	—	—
HA2D	140 {1.4}	20 to 98 {0.2 to 1.0}	Δ	970 {9.9}	760 {7.7}	650 {6.6}	530 {5.4}	410 {4.2}	—	—
	160 {1.6}	20 to 98 {0.2 to 1.0}	✓	3920 {40.0} 4820 {49.2}	3730 {38.0}	3230 {32.9}	2690 {27.4}	2040 {20.8}	—	—
	390 {4.0}	80 to 240 {0.8 to 2.4}	✓	3920 {40.0} 9810 {100}	3920 {40.0} 9810 {100}	3920 {40.0} 9680 {98.7}	3920 {40.0} 8070 {82.3}	3920 {40.0} 6160 {62.8}	—	—
HA3D	140 {1.4}	20 to 98 {0.2 to 1.0}	Δ	1720 {17.5}	1340 {13.7}	1150 {11.7}	950 {9.7}	720 {7.4}	510 {5.2}	—
	160 {1.6}	20 to 98 {0.2 to 1.0}	✓	3920 {40.0} 8530 {87.0}	3920 {40.0} 6570 {67.0}	3920 {40.0} 5690 {58.0}	3920 {40.0} 3630 {48.7}	3630 {37.0}	2560 {26.1}	—
	390 {4.0}	80 to 240 {0.8 to 2.4}	✓	3920 {40.0} 9810 {100}	3920 {40.0} 9810 {100}	3920 {40.0} 9810 {100}	3920 {40.0} 9810 {100}	3920 {40.0} 9810 {100}	3920 {40.0} 7710 {78.6}	—
HA4D	140 {1.4}	20 to 98 {0.2 to 1.0}	Δ	—	—	1980 {20.2}	1640 {16.7}	1260 {12.8}	880 {9.0}	720 {7.4}
	160 {1.6}	20 to 98 {0.2 to 1.0}	✓	—	—	3920 {40.0} 9810 {100}	3920 {40.0} 8230 {83.9}	3920 {40.0} 6240 {63.6}	3920 {40.0} 4410 {45.0}	3630 {37.0}
	390 {4.0}	80 to 240 {0.8 to 2.4}	✓	—	—	3920 {40.0} 9810 {100}	3920 {40.0} 9810 {100}	3920 {40.0} 9810 {100}	3920 {40.0} 9810 {100}	3920 {40.0}

Contoured-type metal seat (%VF, LVF, %V, LV)

Table 6. Reverse action (Air-to-open)

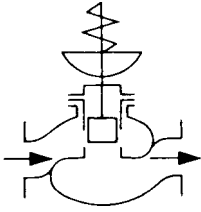

Actuator Model No.	Supply Pressure kgf/cm ² {kPa}	Spring Range kgf/cm ² {kPa}	Positioner	Differential pressure (by nominal size (in.)) kPa {kgf/cm ² }							
				1½	2	2½	3	4	6	8	
HA1R	140 {1.4}	20 to 98 {0.2 to 1.0}	Δ	500 {5.1}	390 {4.0}	—	—	—	—	—	—
	270 {2.8}	80 to 240 {0.8 to 2.4}	✓	3430 {35.0}	2650 {27.0}	—	—	—	—	—	—
HA2R	140 {1.4}	20 to 98 {0.2 to 1.0}	Δ	970 {9.9}	760 {7.7}	650 {6.6}	530 {5.4}	410 {4.2}	—	—	—
	270 {2.8}	80 to 240 {0.8 to 2.4}	✓	3920 {40.0}	3920 {40.0}	3920 {40.0}	3760 {38.4}	2870 {29.3}	—	—	—
				6680 {68.1}	5280 {53.9}	4510 {46.0}					
HA3R	140 {1.4}	20 to 98 {0.2 to 1.0}	Δ	1720 {17.5}	1340 {13.7}	1150 {11.7}	950 {9.7}	720 {7.4}	510 {5.2}	—	—
	270 {2.8}	80 to 240 {0.8 to 2.4}	✓	3920 {40.0}	3920 {40.0}	3920 {40.0}	3920 {40.0}	3920 {40.0}	3600 {36.7}	—	—
				9810 {100}	9380 {95.7}	8010 {81.7}	6670 {68.0}	5080 {51.8}			
HA4R	140 {1.4}	20 to 98 {0.2 to 1.0}	Δ	—	—	1980 {20.2}	1640 {16.7}	1260 {12.8}	880 {9.0}	720 {7.4}	
	270 {2.8}	80 to 240 {0.8 to 2.4}	✓	—	—	3920 {40.0}	3920 {40.0}	3920 {40.0}	3920 {40.0}	3920 {40.0}	
HR5R	140 {1.4}	20 to 98 {0.2 to 1.0}	Δ	—	—	—	—	1720 {17.5}	1210 {12.3}	1000 {10.2}	
	140 {1.4}	40 to 120 {0.4 to 1.2}	Δ	—	—	—	—	3920 {40.0}	3630 {37.0}	3010 {30.7}	
								5100 {52.0}			
270 {2.8}	80 to 240 {0.8 to 2.4}	✓	—	—	—	—	3920 {40.0}	3920 {40.0}	3920 {40.0}		
PSA6R	400 {4.0}	200 to 340 {2.0 to 3.5}	✓	—	—	—	—	3920 {40.0}	—	—	
								9810 {100}			
	500 {5.0}	200 to 390 {2.0 to 4.0}	✓	—	—	—	—	—	3920 {40.0}	—	
								9810 {100}			

Note : 1) "  " shows a model with standard actuator.

2) ✓ : Positioner is necessary, Δ : Can be operated either with or without positioner.

3) Take care not to cause the maximum permissible differential pressure to exceed the maximum operating pressure designated by ANSI B 16. 34-1981 or JIS B2201-1984.

4) The upper figures denote the operating permissible differential pressure: the lower denote permissible differential pressure at full closure.

Soft seat (%TF, LTF, %T, LT)

Table 7. Direct action (Air-to-close)

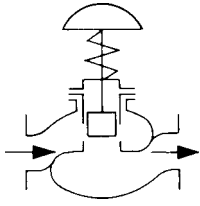

Actuator Model No.	Supply Pressure kgf/cm ² {kPa}	Spring Range kgf/cm ² {kPa}	Positioner	Differential pressure (by nominal size (in.)) kPa {kgf/cm ² }						
				1½	2	2½	3	4	6	8
HA1D	140 {1.4}	20 to 98 {0.2 to 1.0}	Δ	350* {3.6}	270* {2.8}	—	—	—	—	—
	160 {1.6}	20 to 98 {0.2 to 1.0}	✓	1670 {17.0}	1270 {13.0}	—	—	—	—	—
	390 {4.0}	80 to 240 {0.8 to 2.4}	✓	2940 {30.0}	2940 {30.0}	—	—	—	—	—
HA2D	140 {1.4}	20 to 98 {0.2 to 1.0}	Δ	680* {6.9}	530* {5.4}	450* {4.6}	370* {3.8}	280* {2.9}	—	—
	160 {1.6}	20 to 98 {0.2 to 1.0}	✓	2940 {30.0}	2610 {26.6}	2260 {23.0}	1880 {19.2}	1430 {14.6}	—	—
	390 {4.0}	80 to 240 {0.8 to 2.4}	✓	2940 {30.0}	2940 {30.0}	2940 {30.0}	2940 {30.0}	2940 {30.0}	—	—
HA3D	140 {1.4}	20 to 98 {0.2 to 1.0}	Δ	1210* {12.3}	940* {9.6}	800* {8.2}	670* {6.8}	510 {5.2}	350* {3.6}	—
	160 {1.6}	20 to 98 {0.2 to 1.0}	✓	2940 {30.0}	2940 {30.0}	2940 {30.0}	2940 {30.0}	2540 {25.9}	1790 {18.3}	—
	390 {4.0}	80 to 240 {0.8 to 2.4}	✓	2940 {30.0}	2940 {30.0}	2940 {30.0}	2940 {30.0}	2940 {30.0}	2940 {30.0}	—
HA4D	140 {1.4}	20 to 98 {0.2 to 1.0}	Δ	—	—	1380* {14.1}	1150* {11.7}	880* {9.0}	620* {6.3}	510 {5.2}
	160 {1.6}	20 to 98 {0.2 to 1.0}	✓	—	—	2940 {30.0}	2940 {30.0}	2940 {30.0}	2940 {30.0}	2540 {25.9}
	390 {4.0}	80 to 240 {0.8 to 2.4}	✓	—	—	2940 {30.0}	2940 {30.0}	2940 {30.0}	2940 {30.0}	2940 {30.0}

Table 8. Reverse action (Air-to-open)

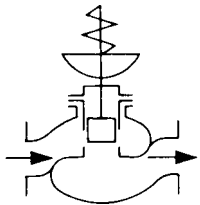

Actuator Model No.	Supply Pressure Kg/cm ² {kPa}	Spring Range Kg/cm ² {kPa}	Positioner	Differential pressure (by nominal size (in.)) kPa {kgf/cm ² }						
				1½	2	2½	3	4	6	8
HA1R	140 {1.4}	20 to 98 {0.2 to 1.0}	Δ	350* {3.6}	270* {2.8}	—	—	—	—	—
	270 {2.8}	80 to 240 {0.8 to 2.4}	✓	2450 {25.0}	1860 {19.0}	—	—	—	—	—
HA2R	140 {1.4}	20 to 98 {0.2 to 1.0}	Δ	680* {6.9}	530* {5.4}	450* {4.6}	370* {3.8}	280* {2.9}	—	—
	270 {2.8}	80 to 240 {0.8 to 2.4}	✓	2940 {30.0}	2940 {30.0}	2940 {30.0}	2640 {26.9}	2010 {20.5}	—	—
HA3R	140 {1.4}	20 to 98 {0.2 to 1.0}	Δ	1210* {12.3}	940* {9.6}	800* {8.2}	670* {6.8}	510 {5.2}	350* {3.6}	—
	270 {2.8}	80 to 240 {0.8 to 2.4}	✓	2940 {30.0}	2940 {30.0}	2940 {30.0}	2940 {30.0}	2940 {30.0}	2520 {25.7}	—
HA4R	140 {1.4}	20 to 98 {0.2 to 1.0}	Δ	—	—	1380* {14.1}	1150* {11.7}	880* {9.0}	620* {6.3}	510 {5.2}
	270 {2.8}	80 to 240 {0.8 to 2.4}	✓	—	—	2940 {30.0}	2940 {30.0}	2940 {30.0}	2940 {30.0}	2940 {30.0}

Note : 1) " " shows a model with standard actuator.

2) ✓ : Positioner is necessary, Δ : Can be operated either with or without positioner.

3) Take care not to cause the maximum permissible differential pressure to exceed the maximum operating pressure designated by ANSI B 16. 34-1981 or JIS B2201-1984.

4) Seat leakages of items marked with asterisk are less than 0.01% (Class IV)

Those for items without asterisk marks are less than 0.00001% (Class VI).

DIMENSIONS

Table 9. Face-to face dimensions

(Unit : mm)

Nominal size (in.)	A							
	JIS 10KFF, RF ANSI 125FF ANSI 150RF JPI 150RF	JIS 16KRF	JIS 20KRF JIS 30KRF ANSI 300RF JPI 300RF	JIS 40KRF ANSI 600RF JPI 600RF	JIS 16K Tongue and groove Male and female	JIS 20K Tongue and groove Male and female	JIS 30K Tongue and groove Male and female	JIS 40K Tongue and groove Male and female
1½	222	231	235	251	235	236	248	251
2	254	263	267	286	265	267	276	286
2½	276	288	292	311	290	292	303	311
3	298	313	317	337	310	317	326	337
4	352	364	368	394	360	368	379	394
6	451	465	473	508	475	473	486	508
8	543	560	568	610	570	568	580	610

Table 10.

(Unit : mm)

Nominal size (in.)	A						
	ANSI 150RJ JPI 150RJ	ANSI 300RJ JPI 300RJ	ANSI 600RJ JPI 600RJ	ANSI 300LG JPI 300LG	ANSI 600LG JPI 600LG	ANSI 150 JPI 150 SW, BW	ANSI 300, 600 JPI 300, 600 SW, BW
1½	235	248	251	244	248	251	251
2	267	283	289	276	283	286	286
2½	289	308	314	302	308	311	311
3	311	333	340	327	333	337	337
4	365	384	397	378	391	394	394
6	464	489	511	483	505	473	508
8	556	584	613	578	606	568	610

Note : Face-to-face dimensions conform to IEC534-3-1976 Specifications.

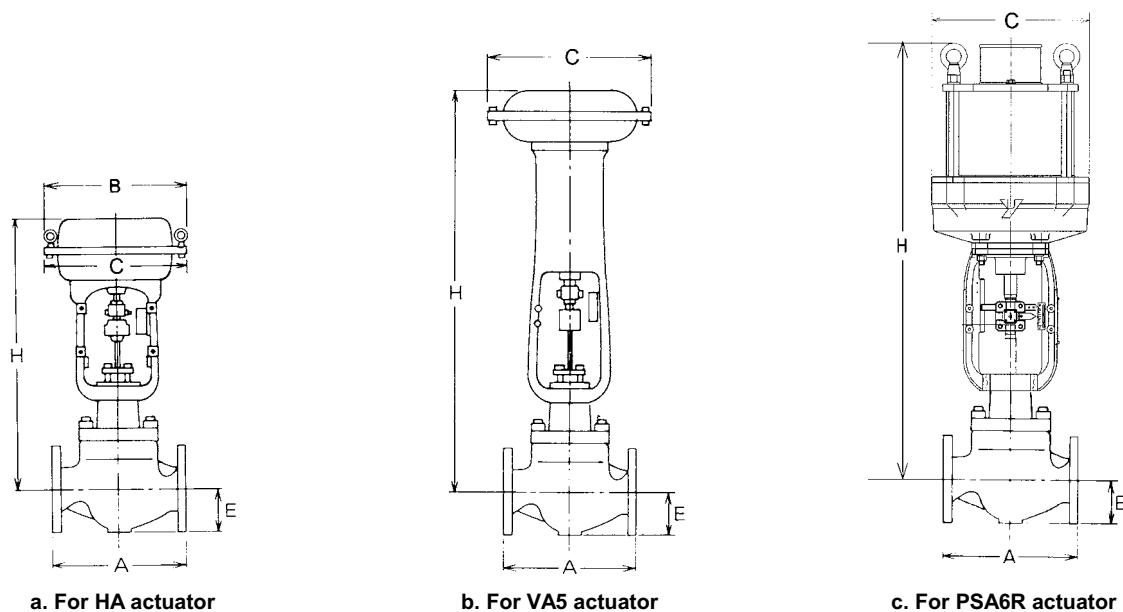

Figure 6. Face-to-face and external dimensions

Table 11. External dimensions

Nominal size (in.)	Actuator Model No.	H					B	C	E
		Plain bonnet	Extention bonnet Type 1	Extention bonnet Type 2		Bellows type bonnet			
				Integral cast type	Welded type				
1½	HA1D, R	425	590	705	945	585	230	218	70
	HA2D, R	500	665	780	1020	660	281	267	
	HA3D, R	590	760	875	1140	750	363	350	
2	HA1D, R	425	595	710	950	585	230	218	80
	HA2D, R	500	670	785	1025	660	281	267	
	HA3D, R	595	765	875	1140	750	363	350	
2½	HA2D, R	575	745/755	880	1130	795	281	267	90
	HA3D, R	630	800/810	930	1180	850	363	350	
	HA4D, R	865	1035/1045	1165	1495	—	520	470	
3	HA2D, R	580	755/765	900	1135	800	281	267	100
	HA3D, R	635	810/820	955	1190	855	363	350	
	HA4D, R	870	1045/1055	1190	1505	—	520	470	
4	HA2D, R	610	810/820	915	1150	830	281	267	115
	HA3D, R	660	860/870	1020	1205	880	363	350	
	HA4D, R	890	1100/1110	1255	1520	—	520	470	
	VA5R	1420	1635	1820	2050	—	—	620	
	PSA6R	1255	1470	1655	1855	—	—	476	
6	HA3D, R	785	1020/1045	1250	1385	1075	363	350	170
	HA4D, R	955	1190/1215	1425	1570	1245	520	470	
	VA5R	1480	1740	1980	2110	—	—	620	
	PSA6R	1315	1575	1815	1945	—	—	476	
8	HA4D, R	1090	1350	1580	1710	1340	—	470	220
	VA5R	1585	1850	2145	2275	—	—	620	

Notes : 1) "H" dimensions are applicable when a handwheel is not provided. When top mounted handwheel HA or VA actuator or side Mounted handwheel PSA6R actuators are used, add the handwheel dimensions designated in respective specification sheets (No.SS2-8213-0500 for Type HA actuators ; No.SS2-8210-0100 and SS2-PSA100-0100 for Type VA, PSA actuators).
 2) "H" dimensions of Extended bonnet Type 1 are as follows : Upper rows for JIS10K and ANSI150, and lower rows for JIS16K and ANSI300 or over.

Table 12. Weight

(Unit : kg)

Nominal size (in.)	Actuator Model No.	Weight															
		Flanged type JIS10K, ANSI • JPI150				Flanged type JIS16K,20K,30K ANSI • JPI300				Flanged type JIS40K, ANSI • JPI600				Welded Type JIS10K,16K,20K,30K ANSI • JPI150,300,600			
		Plain Bonnet	Extension Type 1, Bellows type	Extension Type 2		Plain bonnet	Extension Type 1, Bellows type	Extension Type 2		Plain bonnet	Extension Type 1, Bellows type	Extension Type 2		Plain bonnet	Extension Type 1, Bellows type	Extension Type 2	
Integral cast type	Welded type			Integral cast type	Welded type			Integral cast type	Welded type			Integral cast type	Welded type				
1½	HA1D, R	24	27	30	32	29	32	35	37	37	40	43	45	29	32	35	37
	HA2D, R	31	34	37	39	36	39	42	44	44	47	50	52	36	39	42	44
	HA3D, R	43	46	49	51	48	51	54	56	56	59	62	64	48	51	54	56
2	HA1D, R	30	33	36	38	35	38	41	43	40	43	46	48	35	38	41	43
	HA2D, R	37	40	43	45	42	45	48	50	47	50	53	55	42	45	48	50
	HA3D, R	49	52	55	57	54	57	60	62	59	62	65	67	54	57	60	62
2½	HA2D, R	43	47	51	53	48	52	56	58	65	69	73	75	48	52	56	58
	HA3D, R	55	59	63	65	60	64	68	70	77	81	85	87	60	64	68	70
	HA4D, R	86	90	94	96	91	95	99	101	108	112	116	118	91	95	99	101
3	HA2D, R	53	59	65	68	63	69	75	78	85	91	97	100	63	69	75	78
	HA3D, R	65	71	77	80	75	81	87	90	97	103	109	112	75	81	87	90
	HA4D, R	96	102	108	111	106	112	118	121	128	134	140	143	106	112	118	121
4	HA2D, R	63	73	78	81	78	88	93	96	113	123	128	131	75	85	90	93
	HA3D, R	75	85	90	93	90	100	105	108	125	135	140	143	87	97	102	105
	HA4D, R	106	116	121	124	121	131	136	139	156	166	171	174	118	128	133	136
	VA5R	233	243	248	251	248	258	263	266	283	293	298	301	245	255	260	263
	PSA6R	213	223	228	231	228	238	243	246	258	273	278	281	225	235	240	243
6	HA3D, R	157	172	179	182	187	202	209	212	237	252	259	262	117	192	199	202
	HA4D, R	188	203	210	213	218	233	240	243	268	283	290	293	208	223	230	233
	VA5R	315	330	337	340	345	360	367	370	395	410	417	420	335	350	357	360
	PSA6R	295	310	317	320	325	340	347	350	375	390	397	400	315	330	337	340
8	HA4D, R	268	288	298	303	318	338	348	353	438	458	468	473	308	328	338	343
	VA5R	395	415	425	430	445	465	475	480	565	585	595	600	435	455	465	470

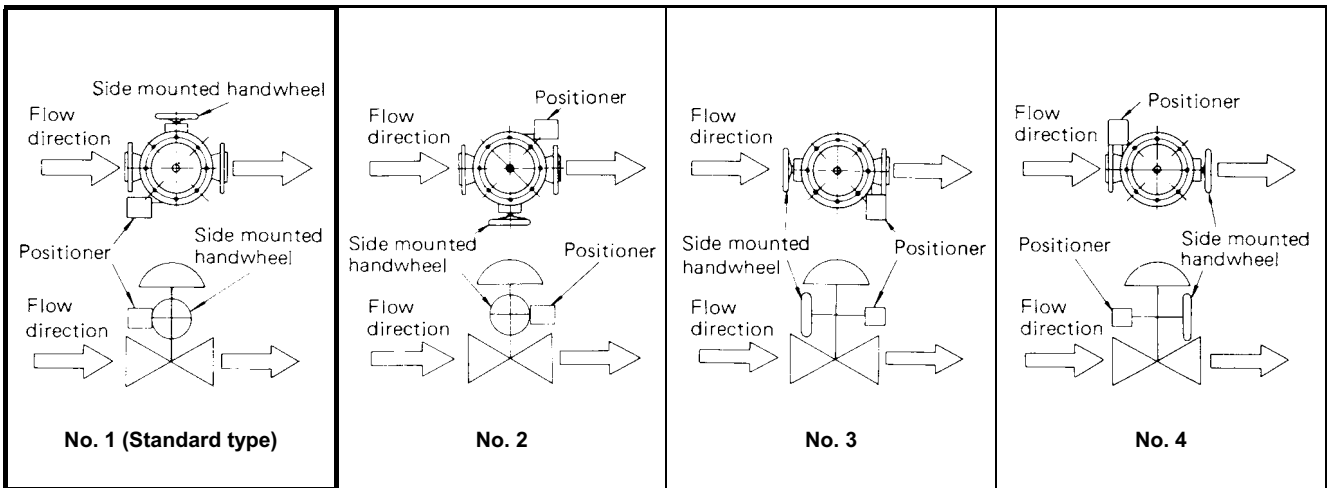

Note : 1) Indicated by position number when installation other than by the standard type is required.

2) HA1 actuator is provided with the top-mounted handwheel only.

3) With Type PSA6R actuator, the side-mounted handwheel is mounted on the same side as the positioner.

Figure 6. Pipe installation positions

Ordering Information

When ordering, please specify ;

- 1) Model Number : HCB
- 2) Nominal size X Port size
- 3) Type and rating of end connections
- 4) Body and trim material, necessity of hardening
- 5) Type of bonnet
- 6) Valve and plug characteristics
- 7) Type of actuator, air to diaphragm
- 8) Valve action (direct or reverse)
- 9) Accessories (positioner, handwheel, pressure regulator etc.)
- 10) Special requirement of degreasing, free from copper and etc.
- 11) Name of flow medium
- 12) Normal flow and maximum required flow
- 13) Pressure of flow medium upstream and downstream pressure at maximum and minimum, required flow
- 14) Temperature and specific gravity of flow medium
- 15) Viscosity of flow medium, inclusive or exclusive of slurry

Yamatake Corporation

Totate international Building
2-12-19 Shibuya
Shibuya-ku, Tokyo 150-8316
Japan

Tel : 81-3-3486-2310

Fax : 81-3-3486-2593

YAMATAKE

Savemation

Saving through Automation