

Clamping sets, rigid shaft couplings, shrink discs

Mechanical clamping elements

Contents

Introduction	
Selection guide	Page 7
Overview	8
Clamping sets/Application examples	10
Clamping sets/Calculation of the minimum hub diameter DM	12
Clamping sets	
TLK 110	14
TLK 130/131	16
TLK 132/133	18
TLK 134	20
TLK 139	22
TLK 200	24
TLK 250/250L	26
TLK 300	28
TLK 350	30
TLK 400/401	32
TLK 450	34
TLK 451/451.0	36
TLK 452	38
Rigid shaft couplings	
TLK500	40
Shrink discs	
TLK 603/602/601	41
TLK 622/623/683	47

**Drive components
are our world.**

Electromagnetically actuated clutches and brakes



Shaft couplings



Locking assemblies



Belt drives



Torque limiters



Universal joints



Linear Motion



Meeting individual customer requirements – and keeping everything securely clamped in place.

Mechanical clamping sets and shrink discs are used for friction-locked and backlash-free connection of shafts and hubs or other machine parts so that torques and axial forces are transmitted successfully between these components.

With our standard portfolio, we supply mechanical clamping sets for shaft diameters of 6 mm to 800 mm and torques of 6 Nm to 2,131,000 Nm. We also supply mechanical shrink discs for shaft diameters of 9 mm to 540 mm and torques of 20 Nm to 4,028,000 Nm.

We will work with you to design your individual solution for friction-locked connection of your mechanical shafts and hubs.

The advantages of friction-locked transmission of torque compared to keyway connections are, for example, long-lasting and indestructible connections, speedy, reliable and easy mounting/removal and the total absence of any backlash. Clamping sets are therefore especially suitable for servo technology and reversing duty. The torque can be transmitted while axial forces are absorbed.





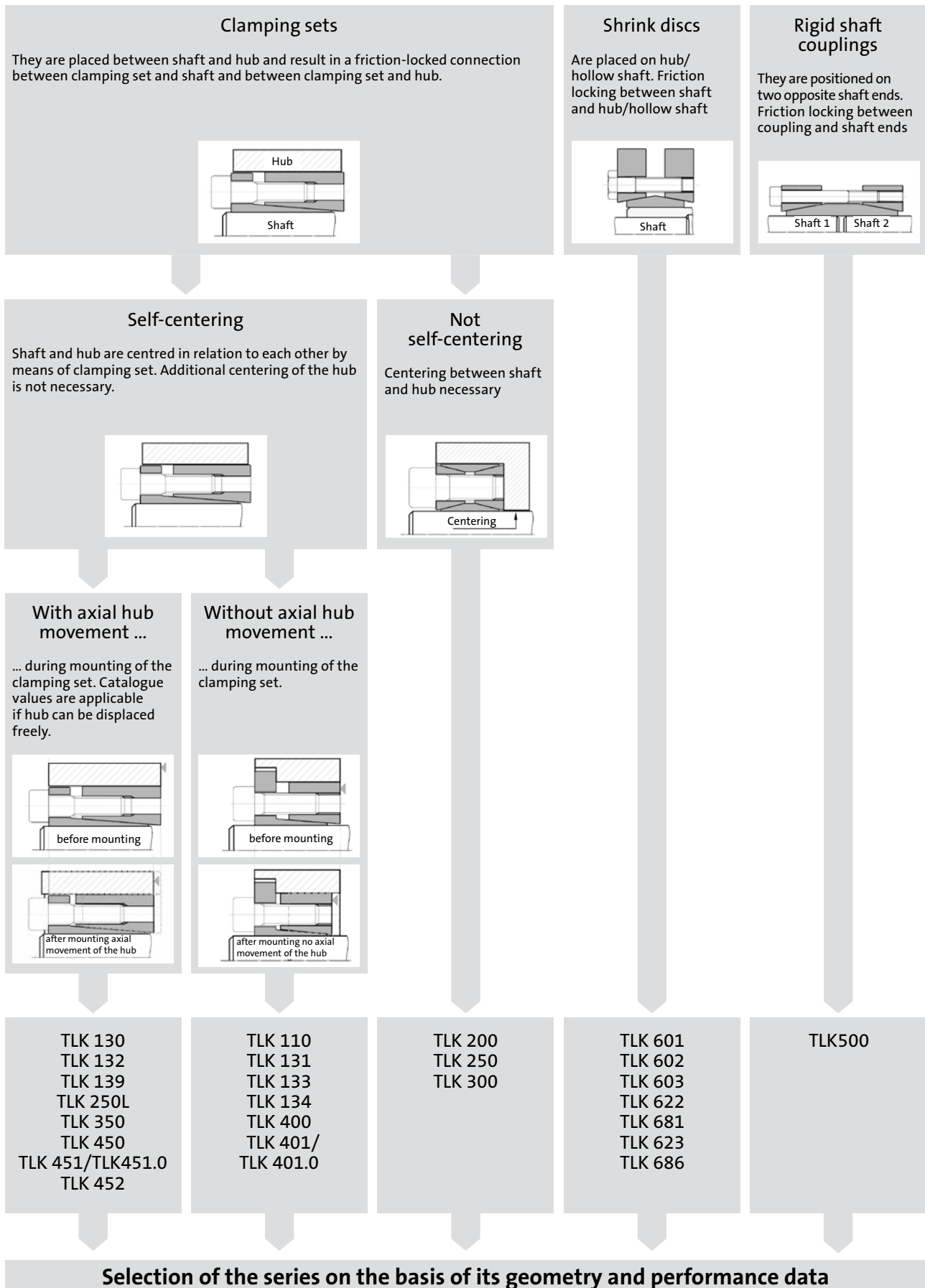

Selection of mechanical clamping elements



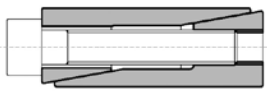

		Type	Shaft diameter [mm]	Torque [Nm]	Axial force [kN]	self-centering	No axial movement during mounting	Page
Clamping sets		TLK 110	6 – 130	16 – 25,000	6 – 389	●	●	14
		TLK 130	18 – 240	490 – 133,700	55 – 1.114	●		16
		TLK 131	18 – 240	300 – 83,350	34 – 695	●	●	16
		TLK 132	18 – 200	330 – 66,250	38 – 662	●		18
		TLK 133	18 – 240	250 – 50,000	28 – 500	●	●	18
		TLK 134	14 – 50	290 – 1,840	42 – 74	●	●	20
		TLK 139	18 – 90	210 – 7,500	23.7 – 168.5	●		22
		TLK 200	17 – 800	300 – 2,131,000	35 – 5,327		●	24
		TLK 250	14 – 70	38 – 1,240	5 – 35			26
		TLK 250L	14 – 60	64 – 1,360	9 – 45	●		26
		TLK 300	6 – 540	2 – 400,000	0,84 – 1,480			28

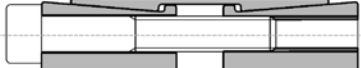
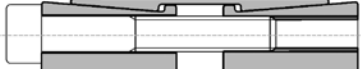
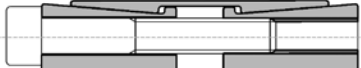

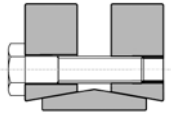
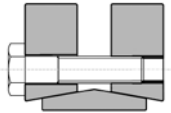
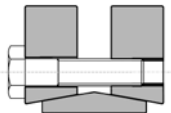
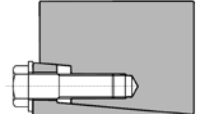
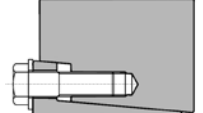
	Type	Shaft diameter [mm]	Torque [Nm]	Axial force [kN]	self-centering	No axial movement during mounting	Page
Clamping sets	 TLK 350	6 – 50	9 – 2,212	3 – 88.5	●		30
	 TLK 400	45 – 400	3.460 – 864,000	155 – 4,320	●	●	31
	 TLK 401 TLK 401.0	70 – 340	5.100 – 348,780	145 – 2,050	●	●	31
	 TLK 450	25 – 400	950 – 926,000	76 – 4,631	●		34
	 TLK 451 TLK 451.0	70 – 600	4.180 – 1,230,000	120 – 4,101	●		36
	 TLK 452	25 – 400	860 – 878,000	69 – 4,394	●		38
Rigid shaft coupling	 TLK500	17 – 80	200 – 4,300	24 – 107	●	●	40
Shrink disc	 TLK 601	95 – 410	10,550 – 935,000	220 – 4,500	●	●	41
	 TLK 602	85 – 380	15.000 – 1,500,000	355 – 7,950	●	●	41
	 TLK 603	11 – 400	30 – 1,310,000	6 – 6,500	●	●	41
	 TLK 622 TLK 681	9 – 540	20 – 4,028,000	5 – 14,918	●	●	47
	 TLK 623 TLK 683	100 – 480	26,000 – 3,956,000	523 – 16,485	●	●	50

Clamping sets

Application examples

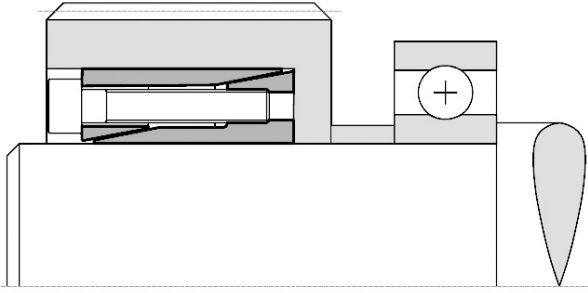
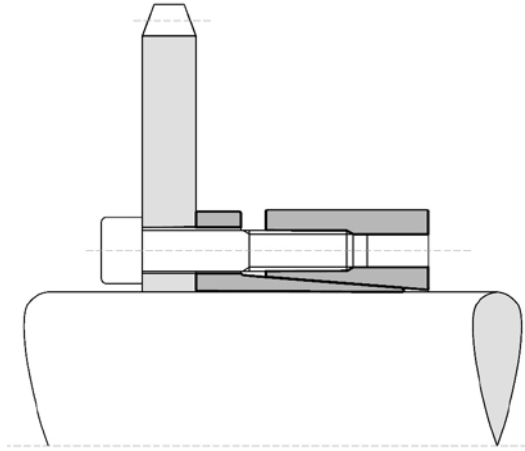
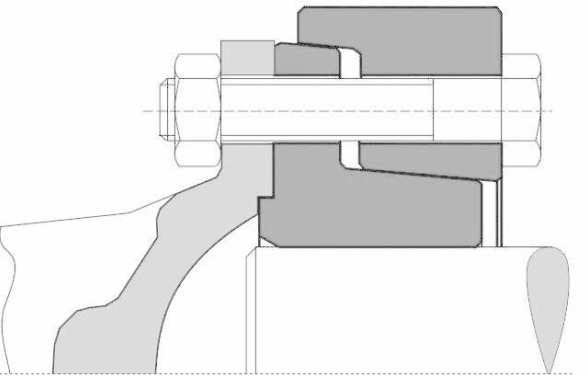
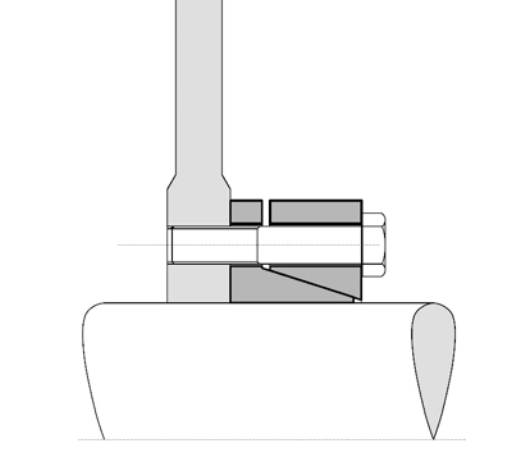
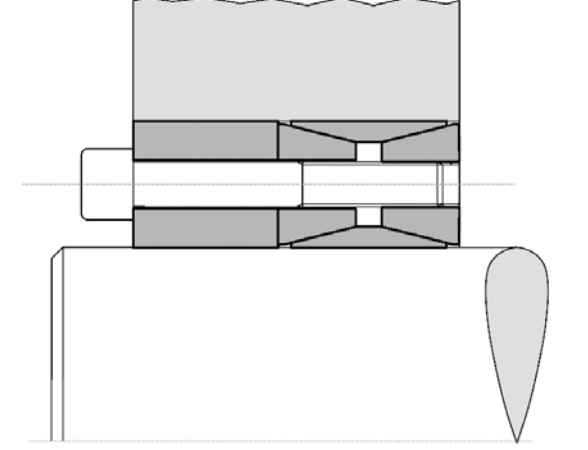
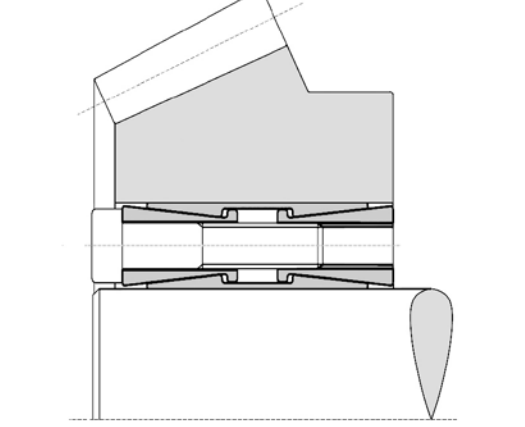

Axial bearing clamping and gear attachment by means of TLK350	Sprocket clamping by means of TLK 130 with non-cut outer ring
	
TLK821 for cardan-shaft mounting	Clamping of a brake disk by means of TLK 700
	
Hub connection by means of TLK 200 with centering ring	Connection of a large hub by means of TLK 400
	



Special version TLK 133 for hub attachment	Use of TLK 300 without spacer
Use of several clamping sets for high torques	Use of TLK 110 for high speeds
Special version TLK 132 with protective ring for the screws	Special version TLK 132 with sealing rings

Clamping sets

Calculation of the minimum hub diameter DM



When clamping sets are mounted, a friction-locked connection is established by means of surface pressure. As a rule, the surface pressure on a solid shaft (p_w) is non-critical. Due to the surface pressure exerted against the hub (p_N), the hub must be checked to make sure it has a minimum diameter. The minimum hub diameter basically depends on the built-in situation (application case), the clamping set used and the hub material. For calculation of the minimum hub diameter, the same formula is used as for a thick hollow cylinder.

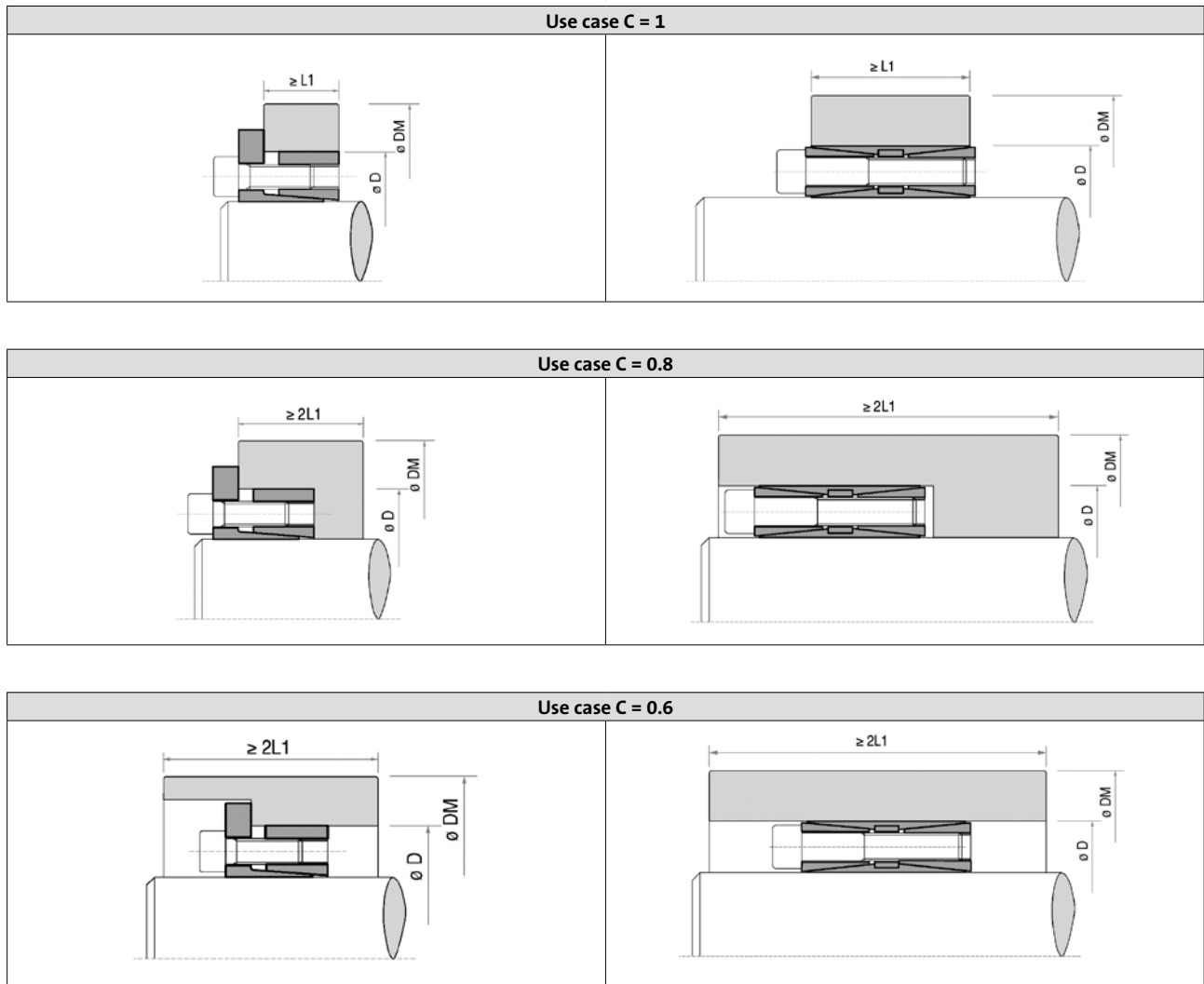

For calculation of the minimum hub diameter DM, the following formula is used:

$$DM \geq D \times K \quad K = \sqrt{\frac{\sigma_{0,2} + (C \times p_N)}{\sigma_{0,2} - (C \times p_N)}}$$

In order to simplify calculation of the minimum hub diameter, the table on page 13 was created for different use cases and hub materials.

Example: Clamping set TLK 131 90x130, surface pressure on the hub $p_N = 85 \text{ N/mm}^2$
 Hub material used GGG40 (yield point $\sigma_{0,2} = 250 \text{ N/mm}^2$)
 Use case (shape and width of hub) corresponds to $C = 1$. **$DM \geq 130 \times 1.42 \geq 184.6 \text{ mm}$**

For calculation of the hollow shaft, the following formula is used:

$$d_i \leq d \times \sqrt{\frac{\sigma_{0,2} - 1,2 \times p_w}{\sigma_{0,2}}} \quad \begin{array}{l} d_i \dots \text{Inner diameter of the hollow shaft} \\ d \dots \text{Outer diameter of the hollow shaft} \end{array}$$



Table for coefficients K

Surface pressure on hub		$\sigma_{0.2}$ Yield point [N/mm ²]										
		150	180	200	220	250	270	300	350	400	450	600
P_N [N/mm ²]	Type of use C	Material										
		GG20	GG25 GS38	GG30 GTS35	GS45 St37-2	GGG40 GS52	St50-2 C35St50-2 C35	GGG50 GS60 St60-2	GGG60 GS62 C45	GGG70 GS70 C60	Tempering steel	
60	C = 0.6	1.28	1.25	1.2	1.18	1.15	1.14	1.12	1.1	1.09	1.08	1.06
	C = 0.8	1.39	1.3	1.24	1.23	1.22	1.2	1.18	1.15	1.12	1.11	1.08
	C = 1	1.52	1.42	1.36	1.32	1.28	1.25	1.22	1.18	1.16	1.14	1.1
65	C = 0.6	1.3	1.25	1.22	1.2	1.18	1.15	1.13	1.11	1.1	1.09	1.07
	C = 0.8	1.44	1.35	1.3	1.28	1.24	1.22	1.2	1.16	1.14	1.12	1.09
	C = 1	1.6	1.45	1.4	1.35	1.3	1.28	1.24	1.2	1.18	1.16	1.12
70	C = 0.6	1.34	1.26	1.24	1.22	1.18	1.16	1.15	1.12	1.11	1.1	1.07
	C = 0.8	1.48	1.38	1.34	1.3	1.25	1.23	1.2	1.18	1.15	1.13	1.1
	C = 1	1.65	1.5	1.45	1.4	1.34	1.3	1.26	1.22	1.2	1.17	1.13
75	C = 0.6	1.3	1.28	1.25	1.23	1.2	1.18	1.16	1.14	1.12	1.11	1.08
	C = 0.8	1.52	1.42	1.36	1.32	1.28	1.25	1.22	1.18	1.16	1.14	1.11
	C = 1	1.74	1.55	1.48	1.42	1.36	1.33	1.3	1.25	1.2	1.18	1.13
80	C = 0.6	1.39	1.31	1.28	1.25	1.21	1.2	1.18	1.15	1.13	1.11	1.08
	C = 0.8	1.58	1.45	1.39	1.35	1.3	1.27	1.24	1.2	1.18	1.15	1.11
	C = 1	1.81	1.61	1.53	1.46	1.39	1.36	1.31	1.26	1.22	1.2	1.14
85	C = 0.6	1.42	1.34	1.3	1.27	1.23	1.21	1.19	1.16	1.14	1.12	1.09
	C = 0.8	1.63	1.49	1.42	1.38	1.32	1.29	1.26	1.22	1.19	1.16	1.12
	C = 1	1.9	1.67	1.57	1.5	1.42	1.39	1.34	1.28	1.24	1.21	1.15
90	C = 0.6	1.46	1.36	1.32	1.28	1.25	1.22	1.2	1.17	1.15	1.13	1.09
	C = 0.8	1.69	1.53	1.46	1.4	1.34	1.31	1.28	1.23	1.2	1.18	1.13
	C = 1	2	1.73	1.62	1.54	1.46	1.41	1.36	1.3	1.26	1.22	1.16
95	C = 0.6	1.49	1.39	1.34	1.3	1.26	1.24	1.21	1.18	1.15	1.14	1.1
	C = 0.8	1.75	1.57	1.49	1.43	1.37	1.34	1.3	1.25	1.21	1.19	1.14
	C = 1	2.11	1.8	1.68	1.59	1.49	1.44	1.39	1.32	1.27	1.24	1.17
100	C = 0.6	1.53	1.41	1.36	1.32	1.28	1.25	1.22	1.19	1.16	1.14	1.11
	C = 0.8	1.81	1.61	1.53	1.46	1.39	1.36	1.31	1.26	1.22	1.2	1.14
	C = 1	2.24	1.87	1.73	1.63	1.53	1.48	1.41	1.34	1.29	1.25	1.18
105	C = 0.6	1.56	1.44	1.39	1.34	1.29	1.27	1.24	1.2	1.17	1.15	1.11
	C = 0.8	1.88	1.66	1.56	1.5	1.42	1.38	1.33	1.28	1.24	1.21	1.15
	C = 1	2.38	1.95	1.79	1.68	1.56	1.51	1.44	1.36	1.31	1.27	1.19
110	C = 0.6	1.6	1.47	1.41	1.36	1.31	1.28	1.25	1.21	1.18	1.16	1.12
	C = 0.8	1.96	1.71	1.6	1.53	1.44	1.41	1.35	1.29	1.25	1.22	1.16
	C = 1	2.55	2.04	1.86	1.73	1.6	1.54	1.47	1.38	1.33	1.28	1.2
115	C = 0.6	1.64	1.5	1.43	1.36	1.33	1.3	1.26	1.22	1.19	1.17	1.12
	C = 0.8	2.04	1.76	1.64	1.56	1.47	1.43	1.37	1.31	1.26	1.23	1.17
	C = 1	2.75	2.13	1.93	1.79	1.64	1.58	1.5	1.41	1.34	1.3	1.21
120	C = 0.6	1.69	1.53	1.46	1.4	1.34	1.31	1.28	1.23	1.2	1.18	1.13
	C = 0.8	2.13	1.81	1.69	1.6	1.5	1.45	1.39	1.33	1.28	1.24	1.18
	C = 1	3	2.24	2	1.84	1.69	1.61	1.53	1.43	1.36	1.31	1.22
125	C = 0.6	1.73	1.56	1.48	1.43	1.36	1.33	1.29	1.24	1.21	1.18	1.13
	C = 0.8	2.24	1.87	1.73	1.63	1.53	1.48	1.41	1.34	1.29	1.25	1.18
	C = 1	3.32	2.35	2.08	1.91	1.73	1.65	1.56	1.45	1.38	1.33	1.24
130	C = 0.6	1.78	1.59	1.51	1.45	1.38	1.35	1.3	1.25	1.22	1.19	1.14
	C = 0.8	2.35	1.93	1.78	1.67	1.56	1.5	1.44	1.36	1.3	1.27	1.19
	C = 1	3.74	2.49	2.17	1.97	1.78	1.69	1.59	1.48	1.4	1.35	1.25
135	C = 0.6	1.83	1.62	1.54	1.47	1.4	1.36	1.32	1.27	1.23	1.2	1.15
	C = 0.8	2.48	2	1.83	1.71	1.59	1.53	1.46	1.38	1.32	1.28	1.2
	C = 1	4.36	2.65	2.27	2.04	1.83	1.73	1.62	1.5	1.42	1.36	1.26
140	C = 0.6	1.88	1.66	1.56	1.5	1.42	1.38	1.33	1.28	1.24	1.21	1.15
	C = 0.8	2.63	2.07	1.88	1.75	1.62	1.55	1.48	1.39	1.33	1.29	1.21
	C = 1	5.39	2.83	2.38	2.12	1.88	1.78	1.66	1.53	1.44	1.38	1.27
145	C = 0.6	1.94	1.69	1.59	1.52	1.44	1.4	1.35	1.29	1.25	1.22	1.16
	C = 0.8	2.8	2.15	1.94	1.8	1.65	1.58	1.5	1.41	1.35	1.3	1.22
	C = 1	7.68	3.05	2.5	2.21	1.94	1.82	1.69	1.55	1.46	1.4	1.28
150	C = 0.6	2	1.73	1.62	1.54	1.46	1.41	1.36	1.3	1.26	1.23	1.16
	C = 0.8	3	2.24	2	1.84	1.69	1.61	1.53	1.43	1.36	1.31	1.23
	C = 1	-	3.32	2.65	2.3	2	1.87	1.73	1.58	1.48	1.41	1.29
155	C = 0.6	2.06	1.77	1.65	1.57	1.48	1.43	1.38	1.31	1.27	1.24	1.17
	C = 0.8	3.25	2.33	2.06	1.89	1.72	1.65	1.55	1.45	1.38	1.33	1.23
	C = 1	-	3.66	2.8	2.4	2.06	1.92	1.77	1.61	1.51	1.43	1.3
160	C = 0.6	2.13	1.81	1.69	1.6	1.5	1.45	1.39	1.33	1.28	1.24	1.18
	C = 0.8	3.55	2.43	2.13	1.94	1.76	1.67	1.58	1.47	1.39	1.34	1.24
	C = 1	-	4.12	3	2.52	2.13	1.98	1.81	1.64	1.53	1.45	1.31
165	C = 0.6	2.21	1.86	1.72	1.62	1.52	1.47	1.41	1.34	1.29	1.25	1.18
	C = 0.8	3.96	2.55	2.21	2	1.8	1.71	1.6	1.49	1.41	1.35	1.25
	C = 1	-	4.8	3.23	2.65	2.21	2.04	1.86	1.67	1.55	1.47	1.33

Clamping sets

TLK 110 self-centering – no axial movement during mounting



Features

- For medium to high torques
- Small radial mounting dimensions
- Quick mounting
- Very low surface pressure
- Self-centering
- No axial movement of the hub during mounting

Mounting:

Clean and lightly oil the contact surfaces of shaft and hub. Insert clamping set into the seat of the hub and push onto the shaft. Tighten clamping screws in steps crosswise with a torque wrench until the indicated tightening torque M_s is reached. The values of M_T and F_A indicated in the table have been calculated for mounting with oil.

N.B.: Do not use oil containing molybdenum disulphide or extreme-pressure additives and do not use grease. The coefficient of friction would otherwise be considerably reduced.

Dismantling:

Undo clamping screws. Screw the screws into the dismantling threads and tighten them in steps crosswise and uniformly until the rear conical ring comes loose. When the clamping set is mounted again oil the screws and the thread.

Tolerances, roughness depth:

A machine turned finish is sufficient.

Maximum permissible tolerances:

h8 for the shaft

H8 for the hub

Maximum roughness depth: R_t max. 16 μm (R_a 3 μm – R_z 13 μm)

How the minimum hub diameter is calculated is shown on page 12. We will be happy to advise you with regard to individual dimensioning and any other questions you may have.

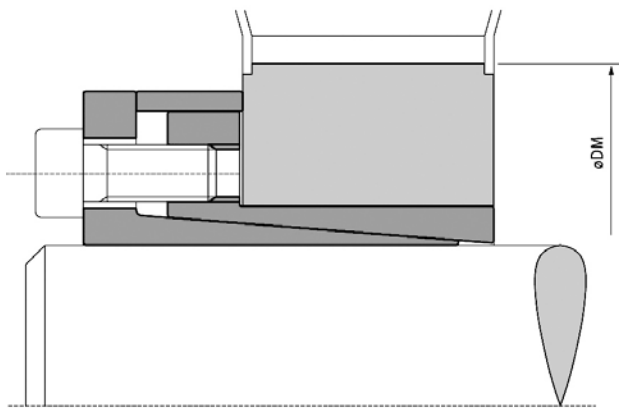



Clamping sets

TLK 110 self-centering – no axial movement during mounting

Dimensions					Torque	Axial force	Surface pressure on		Clamping screws		Weight
							Shaft	Hub	Number DIN 912 12.9	Tightening torque	
dxD [mm]	L1 [mm]	L2 [mm]	B [mm]	D1 [mm]	M _t [Nm]	F _a [kN]	p _w [N/mm ²]	p _N [N/mm ²]	Number x type	M _s [Nm]	[kg]
6 x 14	9	21	24	25	16	6	277	119	4 x M3	2	0.04
7 x 15	12	25	29	27	25	7	234	109	3 x M4	5	0.06
8 x 15	12	25	29	27	29	7	204	109	3 x M4	5	0.05
9 x 16	14	26	30	28	44	10	208	117	4 x M4	5	0.06
10 x 16	14	26	30	28	49	10	187	117	4 x M4	5	0.06
11 x 18	14	26	30	32	53	10	170	104	4 x M4	5	0.07
12 x 18	14	26	30	32	58	10	156	104	4 x M4	5	0.07
13 x 23	14	26	30	38	63	10	144	81	4 x M4	5	0.11
14 x 23	14	26	30	38	68	10	134	81	4 x M4	5	0.1
15 x 23*	14	30	35	39	120	16	204	133	4 x M5	10	0.14
15 x 24	16	36	42	44	170	23	251	157	4 x M6	17	0.22
16 x 24	16	36	42	44	180	23	236	157	4 x M6	17	0.22
17 x 26	18	38	44	47	190	23	197	129	4 x M6	17	0.25
18 x 26	18	38	44	47	200	23	186	129	4 x M6	17	0.24
19 x 27	18	38	44	49	210	23	176	124	4 x M6	17	0.26
19 x 28*	18	38	43	49	150	16	125	85	4 x M5	10	0.27
20 x 28	18	38	44	50	220	23	168	120	4 x M6	17	0.27
22 x 32	25	45	51	54	250	23	110	75	4 x M6	17	0.34
24 x 34	25	45	51	56	270	23	101	71	4 x M6	17	0.36
25 x 34	25	45	51	56	280	23	97	71	4 x M6	17	0.35
28 x 39	25	45	51	61	475	34	129	93	6 x M6	17	0.48
30 x 41	25	45	51	62	510	34	121	88	6 x M6	17	0.48
32 x 43	25	45	51	65	720	45	151	112	8 x M6	17	0.47
35 x 47	30	50	56	69	790	45	115	86	8 x M6	17	0.58
38 x 50	30	50	56	72	860	45	106	80	8 x M6	17	0.61
40 x 53	30	50	56	75	900	45	101	76	8 x M6	17	0.68
42 x 55	32	52	60	78	1,750	84	166	127	8 x M8	41	0.76
45 x 59	40	65	73	85	1,890	84	124	94	8 x M8	41	1.2
48 x 62	45	70	78	87	2,010	84	103	80	8 x M8	41	1.2
50 x 65	45	70	78	92	2,600	105	124	95	10 x M8	41	1.4
55 x 71	50	75	83	98	2,850	105	101	79	10 x M8	41	1.6
60 x 77	50	75	83	104	3,150	105	93	72	10 x M8	41	1.8
65 x 84	50	75	83	111	3,400	105	86	66	10 x M8	41	2.1
70 x 90	60	91	101	119	5,800	167	105	82	10 x M10	83	3
75 x 95	60	91	101	126	6,200	167	98	78	10 x M10	83	3
80 x 100	65	96	106	131	8,000	200	102	82	12 x M10	83	3.5
85 x 106	65	96	106	137	8,500	200	96	77	12 x M10	83	3.6
90 x 112	65	96	106	144	11,250	250	113	91	15 x M10	83	3.9
95 x 120	65	96	106	149	11,850	250	107	85	15 x M10	83	4.4
100 x 125	65	96	106	154	15,000	300	123	98	18 x M10	83	4.6
110 x 140	90	128	140	180	16,000	291	78	61	12 x M12	145	8.7
120 x 155	90	128	140	198	17,500	291	72	55	12 x M12	145	10.6
130 x 165	90	128	140	208	25,000	389	88	69	16 x M12	145	11.3

* Special designs.

Other sizes and individual versions on request.

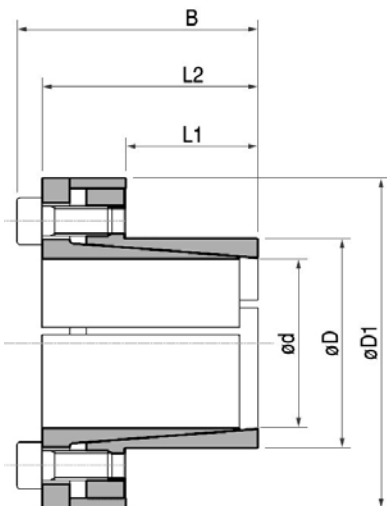

Clamping sets

TLK 130 self-centering – axial movement during mounting
TLK 131 self-centering – no axial movement during mounting



Features

- For high torques
- Quick mounting
- Outstanding perpendicularity of shaft/hub
- TLK 130/131 are self-centering
- In the case of the TLK 131, there is no axial movement of the hub during mounting

Mounting:

Clean and lightly oil the contact surfaces of shaft and hub. Insert clamping set into the seat of the hub and push onto the shaft. Tighten clamping screws in steps crosswise with a torque wrench until the indicated tightening torque M_s is reached. The values of M_T and F_A indicated in the table have been calculated for mounting with oil.

N.B.: Do not use oil containing molybdenum disulphide or extreme-pressure additives and do not use grease. The coefficient of friction would otherwise be considerably reduced.

Dismantling:

Undo clamping screws. Screw the screws into the dismantling threads and tighten them in steps crosswise and uniformly until the rear conical ring comes loose. When the clamping set is mounted again, oil the screws and the thread.

Tolerances, roughness depth:

A machine turned finish is sufficient.

Maximum permissible tolerances:

h8 for the shaft

H8 for the hub

Maximum roughness depth: R_t max. 16 μm (R_a 3 μm – R_z 13 μm)

How the minimum hub diameter is calculated is shown on page 12. We will be happy to advise you with regard to individual dimensioning and any other questions you may have.

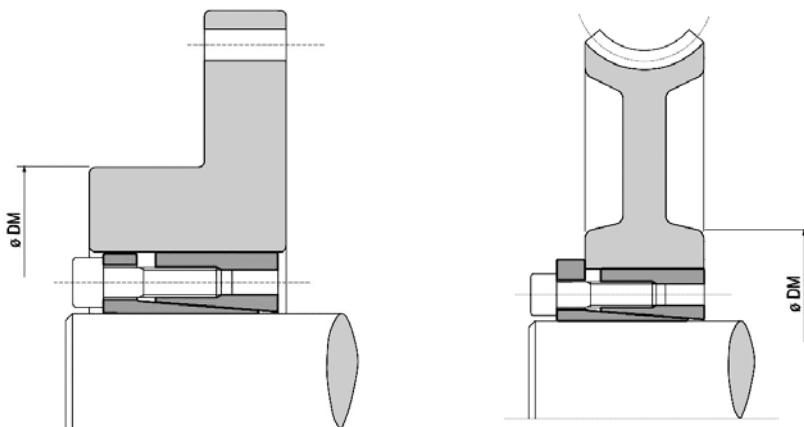



Clamping sets

TLK 130 self-centering – axial movement during mounting
 TLK 131 self-centering – no axial movement during mounting

Dimensions					Only TLK 131	Clamping screws		TLK 130					TLK 131				
								Torque	Axial force	Surface pressure on		Weight	Torque	Axial force	Surface pressure on		Weight
										Shaft	Hub				Shaft	Hub	
dxD [mm]	L1 [mm]	L2 [mm]	L3 [mm]	B [mm]	D1 [mm]	Number x type	M _s [Nm]	M _t [Nm]	F _A [kN]	P _w [N/mm ²]	P _N [N/mm ²]	[kg]	M _t [Nm]	F _A [kN]	P _w [N/mm ²]	P _N [N/mm ²]	[kg]
18 x 47	26	30	41	47	53	6 x M6	17	490	55	310	119	0.4	300	34	193	74	0.5
19 x 47	26	30	41	47	53	6 x M6	17	510	55	294	119	0.4	320	34	183	74	0.5
20 x 47	26	30	41	47	53	6 x M6	17	540	55	279	119	0.4	340	34	174	74	0.5
22 x 47	26	30	41	47	53	6 x M6	17	600	55	254	119	0.4	370	34	158	74	0.5
24 x 50	26	30	41	47	56	6 x M6	17	650	55	233	112	0.4	400	34	145	70	0.5
25 x 50	26	30	41	47	56	6 x M6	17	680	55	223	112	0.4	420	34	139	70	0.5
28 x 55	26	30	41	47	61	6 x M6	17	760	55	199	102	0.5	470	34	124	63	0.6
30 x 55	26	30	41	47	61	6 x M6	17	820	55	186	102	0.5	510	34	116	63	0.6
32 x 60	26	30	41	47	66	8 x M6	17	1.160	73	233	124	0.6	720	45	145	77	0.7
35 x 60	26	30	41	47	66	8 x M6	17	1.270	73	213	124	0.5	790	45	133	77	0.6
38 x 65	26	30	41	47	71	8 x M6	17	1.380	73	196	115	0.6	860	45	122	71	0.8
40 x 65	26	30	41	47	71	8 x M6	17	1.450	73	186	115	0.6	900	45	116	71	0.6
42 x 75	30	35	49	57	81	6 x M8	41	2.120	101	213	119	1	1.320	63	133	74	1.2
45 x 75	30	35	49	57	81	6 x M8	41	2.270	101	199	119	1	1.410	63	124	74	1.1
48 x 80	30	35	49	57	86	8 x M8	41	3.230	135	248	149	1.1	2.010	84	155	93	1.3
50 x 80	30	35	49	57	86	8 x M8	41	3.370	135	238	149	1	2.100	84	149	93	1.1
55 x 85	30	35	49	57	91	8 x M8	41	3.700	135	217	140	1.1	2.310	84	135	87	1.2
60 x 90	30	35	49	57	96	8 x M8	41	4.040	135	199	132	1.2	2.520	84	124	83	1.3
65 x 95	30	35	49	57	101	8 x M8	41	4.380	135	183	125	1.3	2.730	84	114	78	1.4
70 x 110	40	45	59	69	117	8 x M8	83	7.490	214	203	129	2.2	4.670	133	126	80	2.5
75 x 115	40	45	59	69	122	8 x M8	83	8.020	214	189	123	2.5	5.000	133	118	77	2.6
80 x 120	40	45	59	69	127	8 x M8	83	8.560	214	177	118	2.6	5.330	133	111	74	2.8
85 x 125	40	45	59	69	132	10 x M10	83	11.370	268	209	142	2.8	7.080	167	130	88	2.8
90 x 130	40	45	59	69	137	10 x M10	83	12.040	268	197	136	2.7	7.500	167	123	85	3
95 x 135	40	45	59	69	142	10 x M10	83	12.700	268	187	131	2.9	7.920	167	116	82	3
100 x 145	46	52	68	80	153	8 x M12	145	15.580	312	180	124	3.9	9.710	194	112	77	4.5
110 x 155	46	52	68	80	163	8 x M12	145	17.140	312	163	116	4.2	10.680	194	102	72	4.8
120 x 165	46	52	68	80	173	10 x M12	145	23.370	390	187	136	4.8	14.570	243	117	85	5.5
130 x 180	46	52	68	80	188	12 x M12	145	30.380	467	207	150	5	18.940	291	129	93	6
140 x 190	50	57	76	90	199	10 x M14	230	37.410	535	203	149	6.5	23.300	333	126	93	7.5
150 x 200	50	57	76	90	209	12 x M14	230	48.100	641	227	170	7	30.000	400	141	106	7.7
160 x 210	50	57	76	90	219	12 x M14	230	51.300	641	213	162	7	32.000	400	133	101	8
170 x 225	50	57	76	90	234	14 x M14	230	63.600	748	234	176	8.5	39.650	467	146	110	9.8
180 x 235	50	57	76	90	244	14 x M14	230	67.350	748	221	169	9	42.000	467	138	105	9.8
190 x 250	50	57	76	90	259	15 x M14	230	76.150	802	224	170	10.5	47.500	500	140	106	11.4
200 x 260	50	57	76	90	269	16 x M14	230	85.500	855	227	175	10.5	53.300	533	141	109	11.4
210 x 270	50	57	76	90	279	16 x M14	230	89.800	855	216	168	11	56.000	533	135	105	11.8
220 x 285	64	72	94	110	294	12 x M16	355	98.050	891	168	130	16.5	61.150	556	105	81	17.5
240 x 305	64	72	94	110	314	15 x M16	355	133.700	1.114	192	151	18	83.350	695	120	94	18.9

Other sizes, inch dimensions and individual versions on request. N.B.: It is possible to reduce the screw tightening torque M_s to 60% of the value indicated on the dimension sheet. The values of M_t, F_A, p_w and p_N then decrease proportionally.

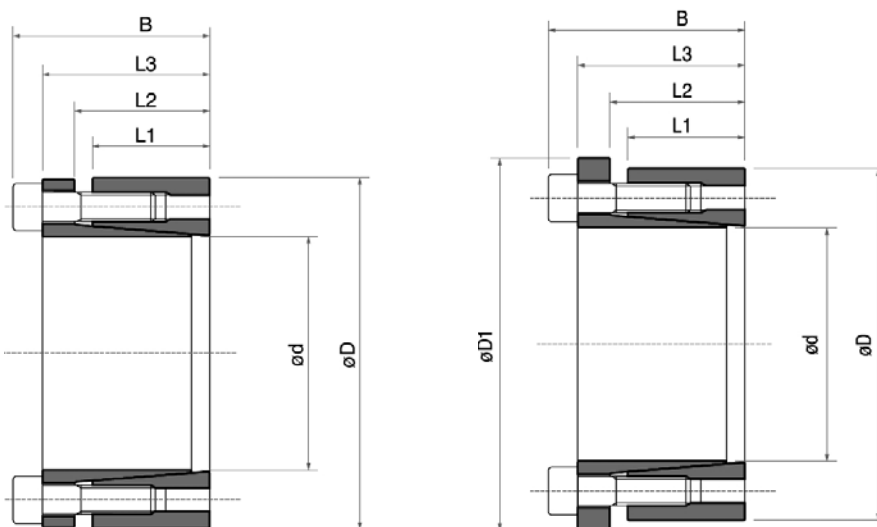

Clamping sets

TLK 132 self-centering – axial movement during mounting
TLK 133 self-centering – no axial movement during mounting



Features

- For medium to high torques
- Quick mounting
- Interchangeable with TLK 200
- TLK 132/133 are self-centering
- In the case of the TLK 133, there is no axial movement of the hub during mounting

Mounting:

Clean and lightly oil the contact surfaces of shaft and hub. Insert clamping set into the seat of the hub and push onto the shaft. Tighten clamping screws in steps crosswise with a torque wrench until the indicated tightening torque M_s is reached. The values of M_T and F_A indicated in the table have been calculated for mounting with oil.

N.B.: Do not use oil containing molybdenum disulphide or extreme-pressure additives and do not use grease. The coefficient of friction would otherwise be considerably reduced.

Dismantling:

Undo clamping screws. Screw the screws into the dismantling threads and tighten them in steps crosswise and uniformly until the rear conical ring comes loose. When the clamping set is mounted again, oil the screws and the thread.

Tolerances, roughness depth:

A machine turned finish is sufficient.

Maximum permissible tolerances:

h8 for the shaft

H8 for the hub

Maximum roughness depth: R_t max. 16 μm (R_a 3 μm – R_z 13 μm)

How the minimum hub diameter is calculated is shown on page 12. We will be happy to advise you with regard to individual dimensioning and any other questions you may have.

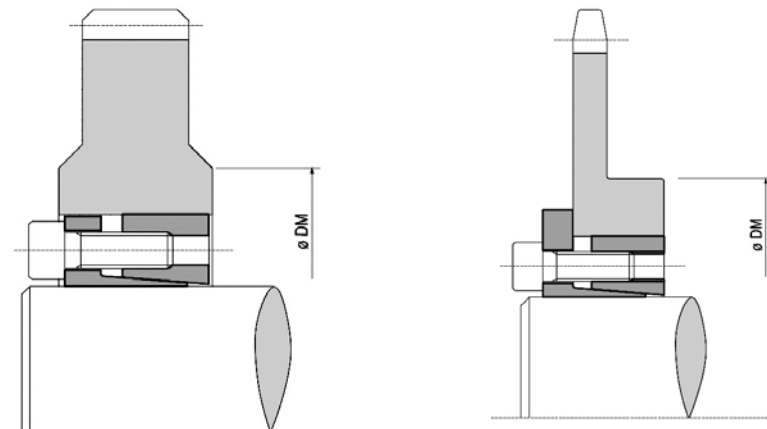



Clamping sets

TLK 132 self-centering – axial movement during mounting
 TLK 133 self-centering – no axial movement during mounting

Dimensions					Only TLK 133	Clamping screws			TLK 132					TLK 133				
						Number DIN 912 12.9	Tightening torque		Torque	Axial force	Surface pressure on		Weight	Torque	Axial force	Axial force		Weight
							Number x type	M ₅ TLK132 [Nm]			M ₅ TLK133 [Nm]	Shaft				Hub	Shaft	
dxD [mm]	L1 [mm]	L2 [mm]	L3 [mm]	B [mm]	D1 [mm]			M _t [Nm]	F _A [kN]	p _w [N/mm ²]	p _N [N/mm ²]	[kg]	M _t [Nm]	F _A [kN]	p _w [N/mm ²]	p _N [N/mm ²]	[kg]	
18 x 47	17	22	28	34	53	5 x M6	14	17	330	38	326	125	0.35	250	28	246	94	0.3
19 x 47	17	22	28	34	53	5 x M6	14	17	350	38	308	125	0.3	270	28	233	94	0.3
20 x 47	17	22	28	34	53	6 x M6	14	17	450	45	352	150	0.3	340	34	266	113	0.3
22 x 47	17	22	28	34	53	6 x M6	14	17	490	45	320	150	0.3	370	34	242	113	0.3
24 x 50	17	22	28	34	56	6 x M6	14	17	540	45	293	141	0.3	400	34	222	106	0.3
25 x 50	17	22	28	34	56	6 x M6	14	17	560	45	281	141	0.3	420	34	213	106	0.3
28 x 55	17	22	28	34	61	6 x M6	14	17	630	45	251	128	0.4	470	34	190	97	0.4
30 x 55	17	22	28	34	61	6 x M6	14	17	670	45	234	128	0.3	510	34	177	97	0.4
32 x 60	17	22	28	34	67	8 x M6	14	17	960	60	293	156	0.4	720	45	222	118	0.4
35 x 60	17	22	28	34	67	8 x M6	14	17	1,050	60	268	156	0.4	790	45	203	118	0.4
38 x 65	17	22	28	34	72	8 x M6	14	17	1,140	60	247	144	0.4	860	45	187	109	0.5
40 x 65	17	22	28	34	72	8 x M6	14	17	1,200	60	234	144	0.4	900	45	177	109	0.5
42 x 75	20	25	33	41	82	8 x M8	35	41	2,410	115	363	204	0.8	1,760	84	265	149	0.8
45 x 75	20	25	33	41	82	8 x M8	35	41	2,580	115	339	204	0.6	1,890	84	248	149	0.7
48 x 80	20	25	33	41	87	8 x M8	35	41	2,760	115	318	191	0.8	2,010	84	232	139	0.8
50 x 80	20	25	33	41	87	8 x M8	35	41	2,870	115	305	191	0.8	2,100	84	223	139	0.8
55 x 85	20	25	33	41	92	8 x M8	35	41	3,160	115	278	180	0.8	2,310	84	203	131	0.9
60 x 90	20	25	33	41	97	8 x M8	35	41	3,450	115	254	170	0.8	2,520	84	186	124	0.9
65 x 95	20	25	33	41	102	9 x M8	35	41	4,200	129	264	181	0.9	3,070	95	193	132	1
70 x 110	24	30	40	50	117	8 x M10	70	83	6,300	181	285	181	1.8	4,670	133	211	134	1.9
75 x 115	24	30	40	50	122	8 x M10	70	83	6,750	181	266	173	1.8	5,000	133	197	128	2
80 x 120	24	30	40	50	127	8 x M10	70	83	7,200	181	249	166	1.8	5,330	133	184	123	2
85 x 125	24	30	40	50	132	10 x M10	70	83	9,600	226	293	200	2	7,080	167	217	147	2
90 x 130	24	30	40	50	137	10 x M10	70	83	10,150	226	277	192	2.1	7,500	167	205	142	2.2
95 x 135	24	30	40	50	142	10 x M10	70	83	10,700	226	263	185	2.1	7,920	167	194	137	2.3
100 x 145	26	32	44	56	152	8 x M12	125	145	13,450	269	274	189	2.8	9,710	194	198	137	3
110 x 155	26	32	44	56	162	8 x M12	125	145	14,750	269	249	177	3	10,700	194	180	128	3.2
120 x 165	26	32	44	56	172	9 x M12	125	145	18,150	302	257	187	3.2	13,100	219	186	135	3.4
130 x 180	34	40	54	66	187	12 x M12	125	145	26,200	403	242	175	4.8	18,950	291	175	126	5.2
140 x 190	34	40	54	68	197	9 x M14	190	230	27,800	397	221	163	5.2	21,000	300	167	123	5.4
150 x 200	34	40	54	68	207	10 x M14	190	230	33,100	442	230	172	5.4	25,000	333	173	130	5.7
160 x 210	34	40	54	68	217	12 x M14	190	230	42,400	530	258	197	5.7	32,000	400	195	149	6
170 x 225	44	50	64	78	232	12 x M14	190	230	45,050	530	188	142	8	34,000	400	142	107	8.3
180 x 235	44	50	64	78	242	12 x M14	190	230	47,700	530	177	136	8.3	36,000	400	134	103	8.8
190 x 250	44	50	64	78	257	15 x M14	190	230	62,900	662	210	160	9.6	47,500	500	159	121	10
200 x 260	44	50	64	78	267	15 x M14	190	230	66,250	662	200	154	10	50,000	500	151	116	10.5

Other sizes, inch dimensions and individual versions on request. N.B.: It is possible to reduce the screw tightening torque M₅ to 60% of the value indicated on the dimension sheet. The values of M_t, F_A, p_w and p_N then decrease proportionally.

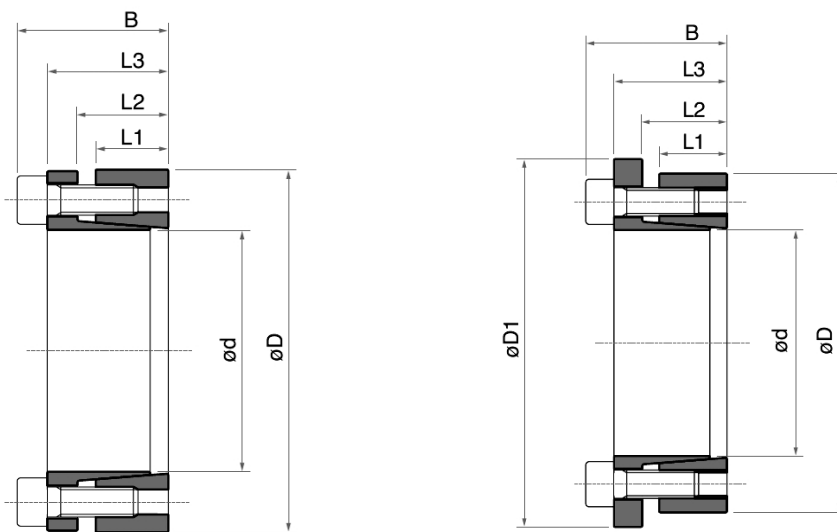

Clamping sets

TLK 134 self-centering – no axial movement during mounting



Features

- For medium to high torques
- The same hub diameters can be clamped onto different shaft diameters
- Quick mounting
- Self-centering
- No axial displacement of the hub during mounting

Mounting:

Clean and lightly oil the contact surfaces of shaft and hub. Insert clamping set into the seat of the hub and push onto the shaft. Tighten clamping screws in steps crosswise with a torque wrench until the indicated tightening torque M_s is reached. The values of M_T and F_A indicated in the table have been calculated for mounting with oil.

N.B.: Do not use oil containing molybdenum disulphide or extreme-pressure additives and do not use grease. The coefficient of friction would otherwise be considerably reduced.

Dismantling:

Undo clamping screws. Screw the screws into the dismantling threads and tighten them in steps crosswise and uniformly until the rear conical ring comes loose. When the clamping set is mounted again, oil the screws and the thread.

Tolerances, roughness depth:

A machine turned finish is sufficient.

Maximum permissible tolerances:

h8 for the shaft

H8 for the hub

Maximum roughness depth: R_t max. 16 μm (R_a 3 μm – R_z 13 μm)

How the minimum hub diameter is calculated is shown on page 12. We will be happy to advise you with regard to individual dimensioning and any other questions you may have.

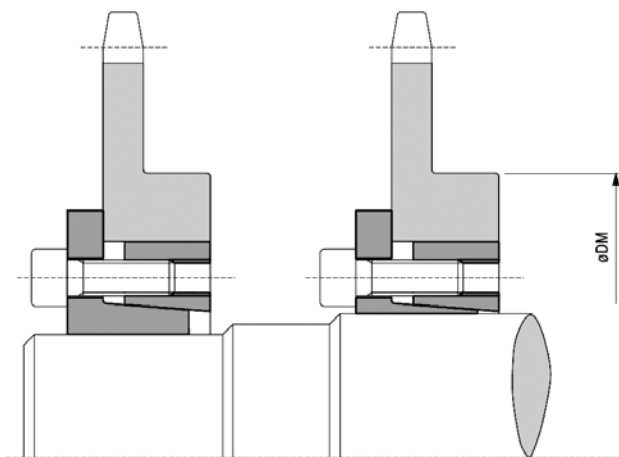



Clamping sets

TLK 134 self-centering – no axial movement during mounting

Dimensions						Torque M_T [Nm]	Axial force F_A [kN]	Surface pressure on		Clamping screws		Weight [kg]
$d \times D$ [mm]	L1 [mm]	L2 [mm]	L3 [mm]	B [mm]	D1 [mm]			Shaft p_w [N/mm ²]	Hub p_n [N/mm ²]	Number DIN 912 12.9	Tightening torque	
								Number x type	M_s [Nm]			
14 x 55	17	22	30	38	62	290	42	468	119	4 x M8	41	0.5
16 x 55	17	22	30	38	62	340	42	410	119	4 x M8	41	0.5
18 x 55	17	22	30	38	62	380	42	364	119	4 x M8	41	0.5
19 x 55	17	22	30	38	62	400	42	345	119	4 x M8	41	0.5
20 x 55	17	22	30	38	62	420	42	328	119	4 x M8	41	0.5
22 x 55	17	22	30	38	62	460	42	298	119	4 x M8	41	0.5
24 x 55	17	22	30	38	62	500	42	273	119	4 x M8	41	0.5
25 x 55	17	22	30	38	62	530	42	262	119	4 x M8	41	0.5
28 x 55	17	22	30	38	62	590	42	234	119	4 x M8	41	0.4
30 x 55	17	22	30	38	62	630	42	219	119	4 x M8	41	0.4
24 x 65	17	22	30	38	72	630	53	342	126	5 x M8	41	0.7
25 x 65	17	22	30	38	72	660	53	328	126	5 x M8	41	0.7
28 x 65	17	22	30	38	72	740	53	293	126	5 x M8	41	0.6
30 x 65	17	22	30	38	72	790	53	273	126	5 x M8	41	0.6
32 x 65	17	22	30	38	72	840	53	256	126	5 x M8	41	0.6
35 x 65	17	22	30	38	72	920	53	234	126	5 x M8	41	0.5
38 x 65	17	22	30	38	72	1,000	53	216	126	5 x M8	41	0.5
40 x 65	17	22	30	38	72	1,050	53	205	126	5 x M8	41	0.5
30 x 80	20	25	33	41	87	1,100	74	325	122	7 x M8	41	1
32 x 80	20	25	33	41	87	1,180	74	305	122	7 x M8	41	1
35 x 80	20	25	33	41	87	1,290	74	279	122	7 x M8	41	1
38 x 80	20	25	33	41	87	1,400	74	257	122	7 x M8	41	1
40 x 80	20	25	33	41	87	1,470	74	244	122	7 x M8	41	0.9
42 x 80	20	25	33	41	87	1,540	74	232	122	7 x M8	41	0.9
45 x 80	20	25	33	41	87	1,650	74	217	122	7 x M8	41	0.9
48 x 80	20	25	33	41	87	1,760	74	203	122	7 x M8	41	0.9
50 x 80	20	25	33	41	87	1,840	74	195	122	7 x M8	41	0.9

Other sizes, inch dimensions and individual versions on request. N.B.: It is possible to reduce the screw tightening torque M_s to 60% of the value indicated on the dimension sheet. The values of M_T , F_A , p_w and p_n then decrease proportionally.

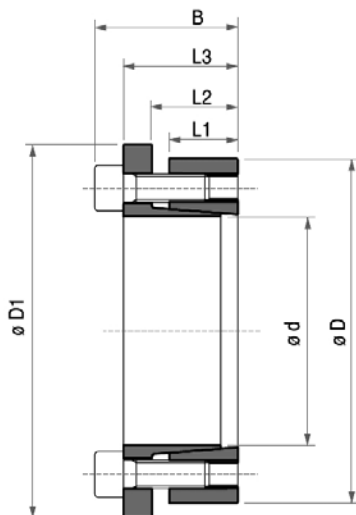

Clamping sets

TLK 139 self-centering – axial movement during mounting



Features

- For low to medium torques
- Quick mounting
- Self-centering
- With axial displacement of the hub during mounting

Mounting:

Clean and lightly oil the contact surfaces of shaft and hub. Insert clamping set into the seat of the hub and push onto the shaft. Tighten clamping screws in steps crosswise with a torque wrench until the indicated tightening torque M_s is reached. The values of M_T and F_A indicated in the table have been calculated for mounting with oil.

N.B.: Do not use oil containing molybdenum disulphide or extreme-pressure additives and do not use grease. The coefficient of friction would otherwise be considerably reduced.

Dismantling:

Undo clamping screws. Screw the screws into the dismantling threads and tighten them in steps crosswise and uniformly until the rear conical ring comes loose. When the clamping set is mounted again, oil the screws and the thread.

Tolerances, roughness depth:

A machine turned finish is sufficient.

Maximum permissible tolerances:

h8 for the shaft

H8 for the hub

Maximum roughness depth: R_t max. 16 μm (R_a 3 μm – R_z 13 μm)

How the minimum hub diameter is calculated is shown on page 12. We will be happy to advise you with regard to individual dimensioning and any other questions you may have.

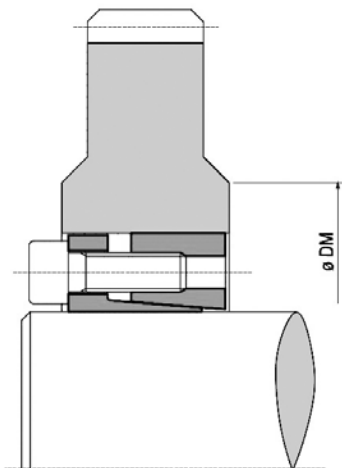



Clamping sets

TLK 139 self-centering – axial movement during mounting

Dimensions					Torque	Axial force	Surface pressure on		Clamping screws		Weight
							Shaft	Hub	Number DIN 912 12.9	Tightening torque	
dxD [mm]	L1 [mm]	L2 [mm]	L3 [mm]	B [mm]	M_0 [Nm]	F_A [kN]	p_w [N/mm ²]	p_n [N/mm ²]	Number x type	M_3 [Nm]	[kg]
18 x 40	12	15	20	24	210	23.7	233	131	6 x M4	5	0.2
19 x 41	12	15	20	24	220	23.7	221	128	6 x M4	5	0.2
20 x 42	12	15	20	24	270	27.7	245	146	7 x M4	5	0.2
22 x 44	12	15	20	24	300	27.7	223	139	7 x M4	5	0.2
24 x 46	12	15	20	24	330	27.7	204	133	7 x M4	5	0.2
25 x 47	12	15	20	24	340	27.7	196	130	7 x M4	5	0.2
28 x 50	12	15	20	24	500	35.6	225	157	9 x M4	5	0.2
30 x 52	12	15	20	24	530	35.6	210	151	9 x M4	5	0.2
32 x 54	12	15	20	24	570	35.6	197	146	9 x M4	5	0.2
35 x 57	16	19	24	28	690	39.5	158	115	10 x M4	5	0.3
36 x 58	16	19	24	28	710	39.5	153	113	10 x M4	5	0.3
38 x 60	16	19	24	28	830	43.5	160	120	11 x M4	5	0.3
40 x 62	16	19	24	28	870	43.5	152	116	11 x M4	5	0.4
42 x 70	19	23	30	36	1,530	73	200	146	8 x M6	17	0.6
45 x 73	19	23	30	36	1,640	73	187	140	8 x M6	17	0.6
48 x 76	19	23	30	36	1,750	73	175	134	8 x M6	17	0.6
50 x 78	19	23	30	36	1,820	73	168	131	8 x M6	17	0.6
55 x 83	19	23	30	36	2,000	73	153	123	8 x M6	17	0.7
56 x 84	19	23	30	36	2,040	73	150	121	8 x M6	17	0.7
60 x 88	19	23	30	36	2,460	82.1	158	130	9 x M6	17	0.7
63 x 91	19	23	30	36	2,580	82.1	150	126	9 x M6	17	0.9
65 x 93	19	23	30	36	2,660	82.1	146	123	9 x M6	17	1
70 x 105	23	28	37	45	4,720	134.8	183	148	8 x M8	41	1.5
75 x 110	23	28	37	45	5,050	134.8	170	141	8 x M8	41	1.5
80 x 115	23	28	37	45	5,390	134.8	160	135	8 x M8	41	1.7
85 x 120	23	28	37	45	5,730	134.8	150	130	8 x M8	41	2
90 x 125	23	28	37	45	7,580	168.5	177	156	10 x M8	41	2.3

Other sizes, inch dimensions and individual versions on request. N.B.: It is possible to reduce the screw tightening torque M_3 to 60% of the value indicated on the dimension sheet. The values of M_0 , F_A , p_w and p_n then decrease proportionally.

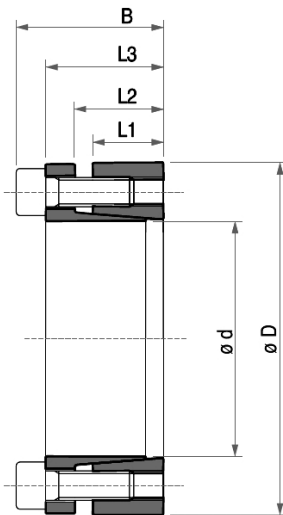

Clamping sets

TLK 200 not self-centering – no axial movement during mounting



Features

- For medium to high torques
- Allows higher tolerances in the case of the shaft and hub
- Not self-centering
- No axial movement of the hub during mounting

Mounting:

Clean and lightly oil the contact surfaces of shaft and hub. Insert clamping set into the seat of the hub and push onto the shaft. Tighten clamping screws in steps crosswise with a torque wrench until the indicated tightening torque M_s is reached. The values of M_T and F_A indicated in the table have been calculated for mounting with oil.

N.B.: Do not use oil containing molybdenum disulphide or extreme-pressure additives and do not use grease. The coefficient of friction would otherwise be considerably reduced.

Dismantling:

Undo clamping screws. The clamping set usually comes off automatically. Otherwise, tap lightly with a hammer on the screw heads in order to release the rear conical ring.

Tolerances, roughness depth:

A machine turned finish is sufficient.

Maximum permissible tolerances:

h11 for the shaft

H11 for the hub

Maximum roughness depth: R_t max. 16 μm (R_a 3 μm – R_z 13 μm)

How the minimum hub diameter is calculated is shown on page 12. We will be happy to advise you with regard to individual dimensioning and any other questions you may have.

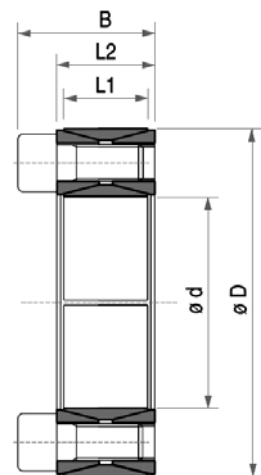
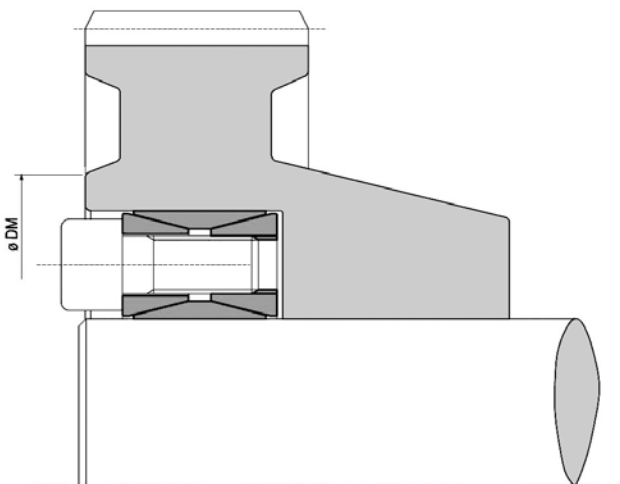



Clamping sets

TLK 200 not self-centering – no axial movement during mounting

Dimensions				Torque	Axial force	Surface pressure on		Clamping screws		Weight
						Shaft	Hub	Number DIN 912 12.9	Tightening torque	
dxD [mm]	L1 [mm]	L2 [mm]	B [mm]	M _t [Nm]	F _a [kN]	P _w [N/mm ²]	P _h [N/mm ²]	Number x type	M _s [Nm]	[kg]
17 x 47	17	20	26	300	35	325	115	8 x M6	17	0.2
18 x 47	17	20	26	310	35	305	115	8 x M6	17	0.2
19 x 47	17	20	26	330	35	290	115	8 x M6	17	0.2
20 x 47	17	20	26	350	35	275	115	8 x M6	17	0.2
22 x 47	17	20	26	380	35	250	115	8 x M6	17	0.2
24 x 50	17	20	26	420	35	230	110	8 x M6	17	0.3
25 x 50	17	20	26	440	35	220	110	8 x M6	17	0.3
28 x 55	17	20	26	610	44	245	125	10 x M6	17	0.3
30 x 55	17	20	26	660	44	230	125	10 x M6	17	0.3
32 x 60	17	20	26	840	53	260	140	12 x M6	17	0.3
35 x 60	17	20	26	920	53	235	140	12 x M6	17	0.3
38 x 65	17	20	26	1,170	62	255	150	14 x M6	17	0.4
40 x 65	17	20	26	1,230	62	240	150	14 x M6	17	0.3
42 x 75	20	24	32	2,050	98	310	175	12 x M8	41	0.6
45 x 75	20	24	32	2,200	98	290	175	12 x M8	41	0.6
48 x 80	20	24	32	2,340	98	270	160	12 x M8	41	0.6
50 x 80	20	24	32	2,440	98	260	160	12 x M8	41	0.6
55 x 85	20	24	32	3,140	114	275	180	14 x M8	41	0.6
60 x 90	20	24	32	3,420	114	255	170	14 x M8	41	0.7
65 x 95	20	24	32	4,240	131	265	180	16 x M8	41	0.7
70 x 110	24	28	38	6,340	181	285	180	14 x M10	83	1.3
75 x 115	24	28	38	6,800	181	265	175	14 x M10	83	1.3
80 x 120	24	28	38	7,250	181	250	165	14 x M10	83	1.4
85 x 125	24	28	38	8,810	207	270	185	16 x M10	83	1.4
90 x 130	24	28	38	9,320	207	255	175	16 x M10	83	1.5
95 x 135	24	28	38	11,070	233	270	190	18 x M10	83	1.6
100 x 145	26	33	45	13,200	264	270	185	14 x M12	145	2.2
110 x 155	26	33	45	14,500	264	245	175	14 x M12	145	2.5
120 x 165	26	33	45	18,100	302	255	185	16 x M12	145	2.6
130 x 180	34	38	50	24,500	377	225	165	20 x M12	145	3.8
140 x 190	34	38	50	29,000	415	230	170	22 x M12	145	3.9
150 x 200	34	38	50	33,900	453	235	175	24 x M12	145	4
160 x 210	34	38	50	39,200	490	240	180	26 x M12	145	4.3
170 x 225	38	44	58	48,400	569	235	175	22 x M14	230	5.8
180 x 235	38	44	58	55,900	621	240	185	24 x M14	230	6
190 x 250	46	52	66	68,800	725	220	165	28 x M14	230	8.5
200 x 260	46	52	66	77,600	776	225	170	30 x M14	230	8.6
220 x 285	50	56	72	102,800	935	225	175	26 x M16	300	11
240 x 305	50	56	72	129,500	1,079	240	190	30 x M16	300	12
260 x 325	50	56	72	159,000	1,223	250	200	34 x M16	300	13
280 x 355	60	66	84	193,900	1,385	220	170	32 x M18	410	19
300 x 375	60	66	84	233,700	1,558	230	185	36 x M18	410	20
320 x 405	72	78	98	323,400	2,021	235	185	36 x M20	590	30
340 x 425	72	78	98	343,600	2,021	220	175	36 x M20	590	30
360 x 455	84	90	112	452,900	2,516	220	175	36 x M22	790	42
380 x 475	84	90	112	478,100	2,516	210	165	36 x M22	790	44
400 x 495	84	90	112	503,200	2,516	200	160	36 x M22	790	46
420 x 515	84	90	112	587,100	2,796	210	170	40 x M22	790	50
440 x 545	96	102	126	710,300	3,229	205	165	40 x M24	1,000	65
460 x 565	96	102	126	742,600	3,229	195	160	40 x M24	1,000	67
480 x 585	96	102	126	813,600	3,390	195	160	42 x M24	1,000	71
500 x 605	96	102	126	887,900	3,552	192	160	44 x M24	1,000	73
520 x 630	96	102	126	944,400	3,632	195	160	45 x M24	1,000	80
540 x 650	96	102	126	980,700	3,632	185	155	45 x M24	1,000	82
560 x 670	96	102	126	1,084,800	3,875	190	160	48 x M24	1,000	85
580 x 690	96	102	126	1,170,400	4,036	190	160	50 x M24	1,000	88
600 x 710	96	102	126	1,210,800	4,036	185	155	50 x M24	1,000	91
620 x 730	96	102	126	1,301,200	4,197	185	160	52 x M24	1,000	93
640 x 750	96	102	126	1,394,800	4,359	190	160	54 x M24	1,000	96
660 x 770	96	102	126	1,491,700	4,520	190	160	56 x M24	1,000	99
680 x 790	96	102	126	1,536,900	4,520	185	160	56 x M24	1,000	102
700 x 810	96	102	126	1,695,100	4,843	190	165	60 x M24	1,000	104
720 x 830	96	102	126	1,743,500	4,843	185	160	60 x M24	1,000	107
740 x 850	96	102	126	1,851,700	5,005	185	165	62 x M24	1,000	110
760 x 870	96	102	126	1,963,100	5,166	190	165	64 x M24	1,000	113
780 x 890	96	102	126	2,046,200	5,247	185	165	65 x M24	1,000	116
800 x 910	96	102	126	2,131,000	5,327	185	160	66 x M24	1,000	118

Other sizes and individual versions on request.

Clamping sets

TLK 250 not self-centering – axial movement during mounting

TLK 250L self-centering – axial movement during mounting



Features

- For low to medium torques
- Quick mounting
- Small radial mounting dimensions
- TLK 250 not self-centering / TLK 250L self-centering
- In the case of the TLK 250/TLK 250L, the hub shows axial movement during mounting

Mounting:

Clean and lightly oil the contact surfaces of shaft and hub. Insert clamping set into the seat of the hub and push onto the shaft. Tighten the groove nut until the indicated tightening torque M_s is reached and fold down the security washer tooth if fitted. The values of M_t and F_A indicated in the table have been calculated for mounting with oil.

N.B.: Do not use oil containing molybdenum disulphide or extreme-pressure additives and do not use grease. The coefficient of friction would otherwise be considerably reduced.

Dismantling:

Undo groove nut. The cone angle of the TLK 250 is around 17° . The clamping set therefore usually comes off automatically. The TLK 250L has a self-locking cone angle and is therefore more difficult to remove. We recommend use of the TLK 250.

Tolerances, roughness depth:

A machine turned finish is sufficient.

Maximum permissible tolerances:

h8 for the shaft

H8 for the hub

Maximum roughness depth: R_t max. $16 \mu\text{m}$ (R_a $3 \mu\text{m}$ – R_z $13 \mu\text{m}$)

How the minimum hub diameter is calculated is shown on page 12. We will be happy to advise you with regard to individual dimensioning and any other questions you may have.

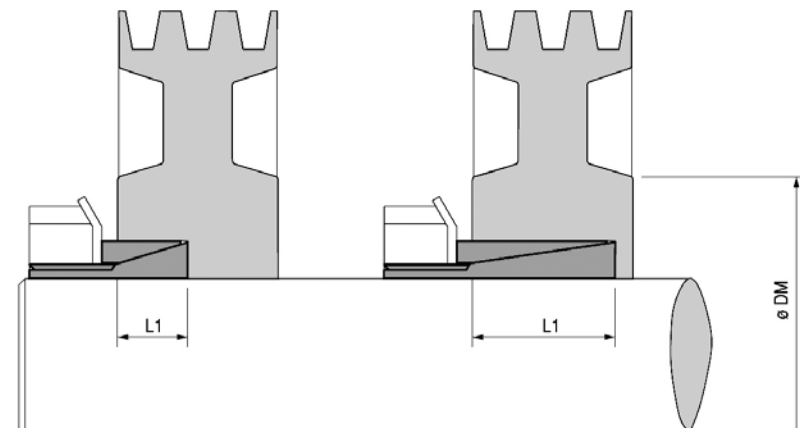



Clamping sets

TLK 250 not self-centering – axial movement during mounting

TLK 250L self-centering – axial movement during mounting

Dimensions				Torque	Axial force	Surface pressure on		Groove nut		Weight
dxD [mm]	B [mm]	L1 [mm]	D1 [mm]			Shaft	Hub	Type DIN 981	Tightening torque	
				M_t [Nm]	F_A [kN]	P_w [N/mm ²]	P_h [N/mm ²]		M_s [Nm]	[kg]
14 x 25	16.5	6.5	32	38	5	200	110	KM4	95	0.05
15 x 25	16.5	6.5	32	41	5	185	110	KM4	95	0.05
16 x 25	16.5	6.5	32	43	5	174	110	KM4	95	0.04
17 x 30	18	6.5	38	55	6	197	112	KM5	160	0.08
18 x 30	18	6.5	38	58	6	186	112	KM5	160	0.08
19 x 30	18	6.5	38	62	7	176	112	KM5	160	0.08
20 x 30	18	6.5	38	66	7	167	111	KM5	160	0.07
22 x 35	18	6.5	45	96	8	202	127	KM6	220	0.1
24 x 35	18	6.5	45	105	9	185	127	KM6	220	0.09
25 x 35	18	6.5	45	110	9	178	127	KM6	220	0.09
28 x 40	19.5	7	52	150	10	176	123	KM7	340	0.07
30 x 40	19.5	7	52	160	11	164	123	KM7	340	0.07
32 x 45	21.5	8	58	210	12	167	120	KM8	480	0.18
35 x 45	21.5	8	58	230	13	153	120	KM8	480	0.17
36 x 45	21.5	8	58	240	13	149	120	KM8	480	0.15
38 x 52	24.5	10	65	290	14	126	93	KM9	680	0.25
40 x 52	24.5	10	65	310	15	120	93	KM9	680	0.24
42 x 57	25.5	10	70	370	17	131	96	KM10	870	0.3
45 x 57	25.5	10	70	400	18	122	96	KM10	870	0.28
48 x 62	25.5	10	75	500	21	135	105	KM11	970	0.32
50 x 62	25.5	10	75	520	21	130	105	KM11	970	0.3
55 x 68	27.5	12	80	610	22	103	84	KM12	1,100	0.36
56 x 68	27.5	12	80	620	22	101	82	KM12	1,100	0.34
60 x 73	28.5	12	85	800	27	113	93	KM13	1,300	0.4
63 x 79	30.5	14	92	980	31	107	86	KM14	1,600	0.56
65 x 79	30.5	14	92	1,010	31	104	86	KM14	1,600	0.52
70 x 84	31.5	14	98	1,240	35	110	92	KM15	2,000	0.6

Dimensions				Torque	Axial force	Surface pressure on		Groove nut		Weight
dxD [mm]	B [mm]	L1 [mm]	D1 [mm]			Shaft	Hub	Type DIN 981	Tightening torque	
				M_t [Nm]	F_A [kN]	P_w [N/mm ²]	P_h [N/mm ²]		M_s [Nm]	[kg]
14 x 25	30	20	32	64	9	85	45	KM4	95	0.08
15 x 25	30	20	32	70	9	80	45	KM4	95	0.08
16 x 25	30	20	32	73	9	75	45	KM4	95	0.07
17 x 25	32	20	32	80	9	70	45	KM4*	95	0.07
18 x 30	32	20	38	100	10	80	45	KM5	160	0.12
19 x 30	32	20	38	105	11	75	45	KM5	160	0.12
20 x 30	32	20	38	112	11	70	45	KM5	160	0.11
22 x 35	36	25	45	163	14	70	45	KM6	220	0.18
24 x 35	36	25	45	178	14	65	45	KM6	220	0.16
25 x 35	36	25	45	185	14	60	45	KM6	220	0.15
28 x 40	42	30	52	250	17	55	40	KM7	340	0.24
30 x 40	42	30	52	270	17	50	40	KM7	340	0.21
32 x 45	44	30	58	350	21	60	45	KM8	480	0.32
35 x 45	44	30	58	390	21	55	45	KM8	480	0.26
38 x 50	45	30	65	500	26	60	45	KM9	680	0.35
40 x 50	45	30	65	520	26	55	45	KM9	680	0.33
42 x 55	46	30	70	630	30	65	50	KM10	870	0.43
45 x 55	46	30	70	680	30	60	50	KM10	870	0.39
48 x 60	46	30	75	840	35	60	50	KM11	970	0.45
50 x 60	46	30	75	880	35	60	50	KM11	970	0.4
55 x 65	46	30	80	1,030	37	60	50	KM12	1,100	0.44
60 x 70	52	30	85	1,360	45	65	55	KM13	1,300	0.55

* Without safety sheet

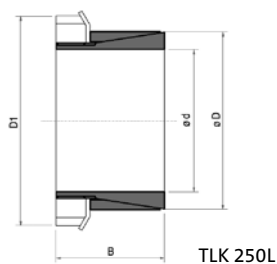
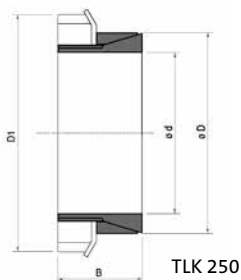

Clamping sets

TLK 300 not self-centering – axial movement during mounting



Features

- For low to medium torques
- Quick mounting, small radial mounting dimensions
- Not self-centering, with axial movement of the hub during mounting
- Slotted version also available as an option.

Mounting:

Clean and lightly oil contact surfaces of shaft and hub. Insert clamping elements, spacer ring and clamping flange. Tighten clamping screws in steps crosswise until the indicated tightening torque M_s has been reached. The values of M_T and F_A indicated in the table have been calculated for mounting with oil.

N.B.: Do not use oil containing molybdenum sulphide or extreme-pressure additives, do not use grease. The coefficient of friction would otherwise be considerably reduced.

Removal:

Undo and remove all clamping screws. As a rule, the TLK 300 is released automatically. If not, hit the hub lightly with a hammer.

Tolerances, roughness depth:

A machine turned finish is sufficient.

Maximum permissible tolerances:

h6 for the shaft/H7 for hub up to $\varnothing 40$ mm; h8 for the shaft/H8 for the hub $\varnothing 42$ mm

Maximum permissible roughness depth: R_t max. $6 \mu\text{m}$ ($R_s 1 \mu\text{m} - R_z 5 \mu\text{m}$)

How the minimum hub diameter is calculated is shown on page 12. We will be happy to advise you with regard to individual dimensioning and any other questions you may have.

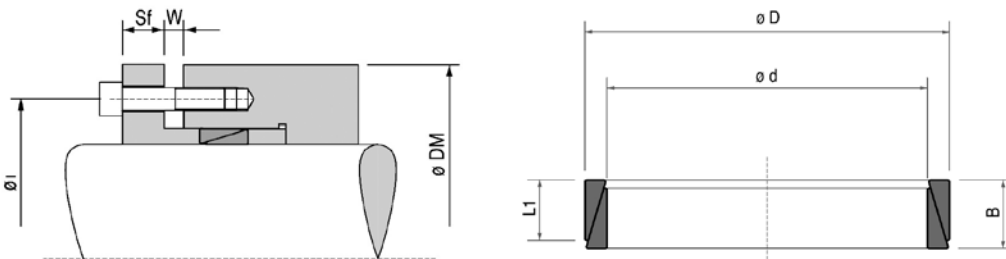

Distance between centres of the screws $\varnothing l = D + 12 + dg$ (screws mounted on hub)

Distance between centres of the screws $\varnothing l = d - 12 - dg$ (screws mounted on shaft)

Flange thickness $Sf = dg \times 1.3$ (screw quality class 8.8)

Flange thickness $Sf = dg \times 1.8$ (screw quality class 12.9)

DIN912				C=0.140		
Total screw force F_s [N]				M_s [Nm]		
dg	8.8	10.9	12.9	8.8	10.9	12.9
M4	3,900	5,450	6,550	2.9	4.1	4.9
M5	6,350	8,950	10,700	6	9	10
M6	9,000	12,600	15,100	10	14	17
[M7]	13,200	18,500	22,200	16	23	28
M8	16,500	23,200	27,900	25	35	41
[M9]	22,000	30,900	37,100	36	51	61
M10	26,200	36,900	44,300	49	69	83
M12	38,300	54,000	64,500	86	120	145
M14	52,500	74,000	88,500	135	190	230
M16	73,000	102,000	123,000	210	295	355
M18	88,000	124,000	148,000	290	405	485
M20	114,000	160,000	192,000	410	580	690
M22	141,000	199,000	239,000	550	780	930
M24	164,000	230,000	276,000	710	1,000	1,200
M27	215,000	302,000	363,000	1,050	1,500	1,800
M30	262,000	368,000	442,000	1,450	2,000	2,400

Torque if several clamping sets are used:

With one TLK 300: $M_T =$ according to catalogue

With two TLK 300: $M_T =$ according to catalogue x 1.55

With three TLK 300: $M_T =$ according to catalogue x 1.85

With four TLK 300: $M_T =$ according to catalogue x 2.02

$F_{Ges} = F_s \times \text{number of screws}$

$F_v =$ See page 29

Transmittable torque:

$$M_T = \frac{F_{GES} - F_v}{0.54} \times 0.12 \times \frac{d}{2000}$$



Clamping sets

TLK 300 not self-centering – axial movement during mounting

Dimensions			Preload force	Total force	Torque	Axial force	Clamping clearance before screws are tightened [mm]				Spacer ring		Surface pressure		Weight [kg]
dxD [mm]	B [mm]	L1 [mm]					F _v [N]	F _{Ges} [N]	M _t [Nm]	F _A [kN]	1*	2*	3*	4*	
6 x 9	4.5	3.7	-	3,800	2	0.84	2.5	2.5	3	4	6.1	8.9	115	75	0.002
7 x 10	4.5	3.7	-	3,900	3	0.86	2.5	2.5	3	4	7.1	9.9	105	70	0.002
8 x 11	4.5	3.7	-	5,300	5	1.17	2.5	2.5	3	4	8.1	10.9	120	90	0.002
9 x 12	4.5	3.7	7,650	15,600	8	1.76	2.5	2.5	3	4	9.1	11.9	140	105	0.002
10 x 13	4.5	3.7	7,000	15,600	10	1.91	2.5	2.5	3	4	10.1	12.9	135	105	0.002
12 x 15	4.5	3.7	7,000	15,600	11	1.91	2.5	2.5	3	4	12.1	14.9	115	90	0.002
13 x 16	4.5	3.7	6,500	15,600	13	2.02	2.5	2.5	3	4	13.1	15.9	110	90	0.002
14 x 18	6.3	5.3	11,000	25,400	22	3.18	3.5	3.5	4.5	5.5	14.1	17.9	115	90	0.005
15 x 19	6.3	5.3	10,800	25,400	24	3.24	3.5	3.5	4.5	5.5	15.1	18.9	110	85	0.005
16 x 20	6.3	5.3	10,000	25,400	27	3.42	3.5	3.5	4.5	5.5	16.1	19.9	105	85	0.006
17 x 21	6.3	5.3	9,600	25,400	30	3.51	3.5	3.5	4.5	5.5	17.1	20.9	105	85	0.006
18 x 22	6.3	5.3	9,150	25,400	32	3.61	3.5	3.5	4.5	5.5	18.1	21.9	100	80	0.007
19 x 24	6.3	5.3	12,500	36,000	49	5.22	3.5	3.5	4.5	5.5	19.2	23.8	140	110	0.007
20 x 25	6.3	5.3	12,000	36,000	53	5.33	3.5	3.5	4.5	5.5	20.2	24.8	135	105	0.009
22 x 26	6.3	5.3	9,000	36,000	66	6	3.5	3.5	4.5	5.5	22.2	25.8	135	115	0.007
24 x 28	6.3	5.3	8,400	36,000	73	6.13	3.5	3.5	4.5	5.5	24.2	27.8	130	110	0.008
25 x 30	6.3	5.3	10,000	36,000	72	5.77	3.5	3.5	4.5	5.5	25.2	29.8	115	95	0.009
28 x 32	6.3	5.3	7,500	36,000	88	6.33	3.5	3.5	4.5	5.5	28.2	31.8	115	100	0.01
30 x 35	6.3	5.3	8,600	36,000	91	6.08	3.5	3.5	4.5	5.5	30.2	34.8	100	85	0.011
32 x 36	6.3	5.3	7,900	45,000	131	8.24	3.5	3.5	4.5	5.5	32.2	35.8	130	115	0.011
35 x 40	7	6	10,000	54,000	171	9.77	3.5	3.5	4.5	5.5	35.2	39.8	125	110	0.016
36 x 42	7	6	11,700	54,000	169	9.39	3.5	3.5	4.5	5.5	36.2	41.8	115	100	0.019
38 x 44	7	6	11,000	54,000	181	9.55	3.5	3.5	4.5	5.5	38.2	43.8	110	95	0.021
40 x 45	8	6.6	13,900	66,000	231	11.57	3.5	4.5	5.5	6.5	40.2	44.8	115	105	0.021
42 x 48	8	6.6	15,550	66,000	235	11.22	3.5	4.5	5.5	6.5	42.2	47.8	110	95	0.026
45 x 52	10	8.6	28,300	99,000	353	15.71	3.5	4.5	5.5	6.5	45.2	51.8	105	95	0.045
48 x 55	10	8.6	24,700	132,000	572	23.84	3.5	4.5	5.5	6.5	48.2	54.8	155	135	0.043
50 x 57	10	8.6	23,600	132,000	602	24.08	3.5	4.5	5.5	6.5	50.2	56.8	150	130	0.045
55 x 62	10	8.6	21,700	132,000	670	24.35	3.5	4.5	5.5	6.5	55.2	61.8	140	125	0.049
56 x 64	12	10.4	29,500	157,200	790	28.2	3.5	4.5	5.5	7	56.2	63.8	130	115	0.07
60 x 68	12	10.4	27,500	157,200	860	28.6	3.5	4.5	5.5	7	60.2	67.8	125	110	0.07
63 x 71	12	10.4	26,500	157,200	910	28.8	3.5	4.5	5.5	7	63.2	70.8	120	105	0.08
65 x 73	12	10.4	25,500	157,200	950	29.2	3.5	4.5	5.5	7	65.2	72.8	115	100	0.09
70 x 79	14	12.2	31,000	209,600	1,380	39.4	3.5	5	6.5	7.5	70.3	78.7	125	110	0.115
71 x 80	14	12.2	31,000	209,600	1,400	39.4	3.5	5	6.5	7.5	71.3	79.7	120	110	0.11
75 x 84	14	12.2	34,700	209,600	1,450	38.6	3.5	5	6.5	7.5	75.3	83.7	115	100	0.12
80 x 91	17	15	48,000	290,000	2,200	55	4	6	6.5	8	80.3	90.7	125	105	0.21
85 x 96	17	15	45,500	305,000	2,400	56.4	4	6	6.5	8	85.3	95.7	120	105	0.21
90 x 101	17	15	43,600	320,000	2,730	60.5	4	6	6.5	8	90.3	100.7	120	105	0.22
95 x 106	17	15	41,300	330,000	3,050	64.2	4	6	6.5	8	95.3	105.7	120	110	0.23
100 x 114	21	18.7	61,000	445,000	4,200	84	5	6	7	9	100.3	113.7	120	105	0.39
110 x 124	21	18.7	66,000	485,000	5,150	93.6	5	6	7	9	110.3	123.7	120	105	0.42
120 x 134	21	18.7	60,300	510,000	6,050	100.8	5	6	7	9	120.2	133.7	120	105	0.46
130 x 148	28	25.3	96,300	765,000	9,600	147.6	5	7	9	11	130.4	147.6	120	105	0.86
140 x 158	28	25.3	89,000	800,500	11,000	158.5	6	7	9	11	140.4	157.6	120	105	0.96
150 x 168	28	25.3	85,000	860,000	12,900	172	6	7	8	11	150.4	167.6	120	105	1
160 x 178	28	25.3	78,600	900,000	14,600	182.5	6	7	9	11	160.4	177.6	120	110	1
170 x 191	33	30	117,400	1,160,000	19,500	229	7	9	10	12	170.5	190.5	120	105	1.54
180 x 201	33	30	111,300	1,200,000	21,300	236	7	9	10	12	180.5	200.5	120	105	1.5
190 x 211	33	30	105,000	1,260,000	24,200	255	7	9	10	12	190.5	210.5	120	110	1.8
200 x 224	38	34.8	134,200	1,550,000	31,000	310	7	8	11	13	200.6	223.4	120	105	2.4
210 x 234	38	34.8	127,200	1,610,000	35,000	333	7	9	11	13	210.6	233.4	120	110	2.5
220 x 244	38	34.8	122,100	1,690,000	38,000	345	7	9	11	13	220.6	243.4	120	110	2.6
230 x 257	43	39.5	164,500	2,000,000	47,000	408	7	10	12	14	230.6	256.4	120	105	3.4
240 x 267	43	39.5	157,400	2,250,000	51,000	425	7	10	12	14	240.6	266.4	120	110	3.8
250 x 280	48	44	190,000	2,060,000	52,000	415	7	10	13	16	250.8	279.2	100	89	4.8
260 x 290	48	44	182,000	2,132,000	56,500	435	7	10	13	16	260.8	289.2	100	89	4.9
270 x 300	48	44	177,000	2,207,000	61,000	450	7	10	13	16	270.8	299.2	100	89	5
280 x 313	53	49	206,000	2,536,000	72,500	520	7	11	14	17	280.8	312.2	100	89	6.4
290 x 323	53	49	222,000	2,632,000	77,500	535	7	11	14	17	290.8	322.2	100	89	6.5
300 x 333	53	49	214,000	2,704,000	83,000	555	7	11	14	17	300.8	332.2	100	89	6.8
320 x 360	65	59	292,000	3,492,000	114,000	710	10	15	20	25	321	359	100	89	11
340 x 380	65	59	272,000	3,672,000	128,500	755	10	15	20	25	341	379	100	89	11.5
360 x 400	65	59	258,000	3,858,000	144,000	800	10	15	20	25	361	399	100	90	12.3
380 x 420	65	59	269,000	4,069,000	160,500	845	10	15	20	25	381	419	100	90	13
400 x 440	65	59	256,000	4,256,000	178,000	890	10	15	20	25	401	439	100	90	13.7
420 x 460	65	59	244,000	4,444,000	196,000	935	10	15	20	25	421	459	100	90	14.1
440 x 480	65	59	234,000	4,633,000	215,000	980	10	15	20	25	441	479	100	90	14.8
460 x 500	65	59	224,000	4,824,000	235,000	1,020	10	15	20	25	461	499	100	91	15.5
480 x 520	65	59	239,000	5,039,000	256,000	1,070	10	15	20	25	481	519	100	91	16
500 x 540	65	59	229,000	5,229,000	278,000	1,110	10	15	20	25	501	539	100	91	16.7
520 x 570	80	73	338,000	6,788,000	372,000	1,430	12	18	24	30	521	569	100	91	27
540 x 590	80	73	326,000	7,026,000	400,000	1,480	12	18	24	30	541	589	100	91	28

* Number of clamping elements used.
Other sizes and individual versions on request.

Clamping sets

TLK 350 self-centering – axial movement during mounting



Features

- For low to medium torques
- Quick mounting
- Self-centering
- With axial movement of the hub during mounting

Mounting:

See page 24.

Dismantling:

Unscrew and remove clamping screws. Screw screws into the forcing threads and tighten in steps crosswise until the rear conical ring becomes detached. If the clamping set is mounted again, oil the screws and the thread.

Tolerances, roughness depth:

A machine turned finish is sufficient.

Maximum permissible tolerances:

h8 for the shaft

H8 for the hub

Maximum roughness depth: R_t max. 16 μm (R_a 3 μm – R_z 13 μm)

How the minimum hub diameter is calculated is shown on page 12. We will be happy to advise you with regard to individual dimensioning and any other questions you may have.

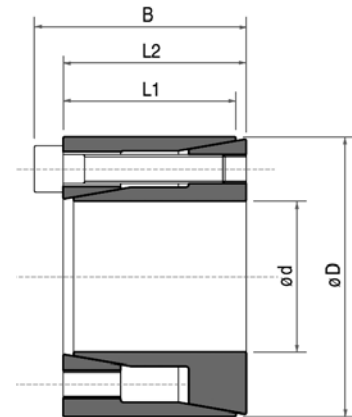

Dimensions				Torque	Axial force	Surface pressure on		Clamping screws		Weight
dxD [mm]	L1 [mm]	L2 [mm]	B [mm]			Shaft	Hub	Number DIN 912 12.9	Tightening torque	
				M_t [Nm]	F_A [kN]	P_w [N/mm ²]	P_N [N/mm ²]	Number x type	M_s [Nm]	[kg]
6 x 16	10.5	11	13.5	9	3	184	69	3 x M2.5	1.2	0,012
6.35 x 16	10,5	11	13,5	10	3	173	69	3 x M2.5	1.2	0.012
7 x 17	10.5	11	13.5	11	3	157	65	3 x M2.5	1.2	0,013
8 x 18	10.5	11	13.5	12	3	138	61	3 x M2.5	1.2	0.015
9 x 20	12.5	13	15.5	18	4	138	62	4 x M2.5	1.2	0.02
9.53 x 20	12,5	13	15,5	19	4	130	62	4 x M2.5	1.2	0,02
10 x 20	12.5	13	15.5	20	4	124	62	4 x M2.5	1.2	0.019
11 x 22	12.5	13	15.5	22	4	113	56	4 x M2.5	1.2	0.024
12 x 22	12.5	13	15.5	24	4	104	56	4 x M2.5	1.2	0.022
14 x 26	16.5	17	20	42	6	99	53	4 x M3	2.1	0.039
15 x 28	16.5	17	20	44	6	93	50	4 x M3	2.1	0.044
16 x 32	16.5	17	21	83	10.4	152	76	4 x M4	4.9	0.067
17 x 35	20.5	21	25	88	10.4	116	56	4 x M4	4.9	0.09
18 x 35	20.5	21	25	93	10.4	109	56	4 x M4	4.9	0.087
19 x 35	20.5	21	25	99	10.4	104	56	4 x M4	4.9	0.083
20 x 38	20.5	21	26	170	17	161	85	4 x M5	10	0.1
22 x 40	20.5	21	26	187	17	146	80	4 x M5	10	0.11
24 x 47	25	26	32	287	24	153	78	4 x M6	17	0.2
25 x 47	25	26	32	299	24	147	78	4 x M6	17	0.19
25.4 x 47	25	26	32	304	24	144	78	4 x M6	17	0.18
28 x 50	25	26	32	503	36	196	110	6 x M6	17	0.22
30 x 55	25	26	32	539	36	183	100	6 x M6	17	0.27
32 x 55	25	26	32	575	36	172	100	6 x M6	17	0.25
35 x 60	30	31	37	838	48	176	102	8 x M6	17	0.36
38 x 65	30	31	37	910	48	162	95	8 x M6	17	0.43
40 x 65	30	31	37	958	48	154	95	8 x M6	17	0.4
42 x 75	35	36	44	1,394	66.3	175	98	6 x M8	41	0.67
45 x 75	35	36	44	1,493	66.3	163	98	6 x M8	41	0.63
48 x 80	35	36	44	2,124	88.5	204	122	8 x M8	41	0.74
50 x 80	35	36	44	2,212	88.5	196	122	8 x M8	41	0.7



Clamping sets

TLK 400 self-centering – no axial movement during mounting
TLK 401 self-centering – no axial movement during mounting

Features

- For very high torques
- Absorption of bending torques (Please consult our technicians)
- Uniform distribution of surface pressure
- Self-centering
- No axial displacement of the hub during mounting

Mounting:

Clean and lightly oil the contact surfaces of shaft and hub. Insert clamping set into seat of hub and push onto the shaft. Tighten clamping screws in steps crosswise and uniformly with a torque wrench until 50% of the indicated tightening torque M_s is reached. Then repeat the process with the full tightening torque. Starting with the last tightened screw and proceeding in a clockwise direction, check that all the clamping screws have been tightened with the correct tightening torque M_s . This concludes the mounting process. If the clamping screws are to be capable of being undone manually, they can be pretensioned with 60% of the indicated tightening torque. The values of M_T and F_A indicated in the table have been calculated for mounting with oil.

N.B.: Do not use oil containing molybdenum disulphide or extreme-pressure additives and do not use grease. The coefficient of friction would otherwise be considerably reduced.

Dismantling:

Undo and remove clamping screws and insert into the dismantling threads of the front conical ring. Tighten screws in steps crosswise and uniformly with 50% of the tightening torque. Repeat the process with the full tightening torque. When the front conical ring has been released, the screws must be screwed into the intermediate ring and the process for releasing the rear conical ring must be repeated as described above.

Tolerances, roughness depth:

A machine turned finish is sufficient.

Maximum permissible tolerances:

h8 for the shaft

H8 for the hub

Maximum roughness depth: R_t max. 16 μm (R_a 3 μm – R_z 13 μm)

How the minimum hub diameter is calculated is shown on page 12. We will be happy to advise you with regard to individual dimensioning and any other questions you may have.

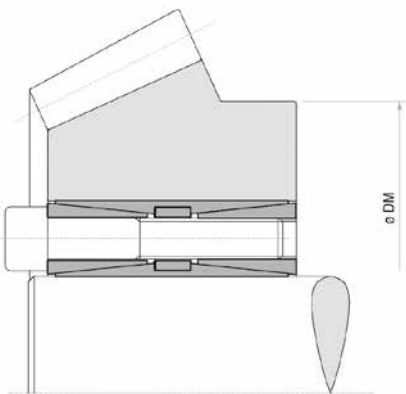

Clamping sets

TLK 400 self-centering – no axial movement during mounting



Dimensions				Clamping screws		Torque	Axial force	Surface pressure		Weight
				Number DIN 912 12.9	Tightening torque			Shaft	Hub	
dxD [mm]	L1 [mm]	L2 [mm]	B [mm]	Number x type	M _s [Nm]	M _T [Nm]	F _A [kN]	p _w [N/mm ²]	p _N [N/mm ²]	[kg]
45 x 75	56	64	72	8 x M8	41	3,460	155	165	100	1.3
48 x 80	56	64	72	8 x M8	41	3,680	155	150	95	1.5
50 x 80	56	64	72	8 x M8	41	3,820	155	147	95	1.4
55 x 85	56	64	72	8 x M8	41	4,260	155	135	85	1.5
60 x 90	56	64	72	10 x M8	41	5,820	190	155	100	1.5
65 x 95	56	64	72	10 x M8	41	6,270	190	140	95	1.6
70 x 110	70	78	88	10 x M10	83	10,730	305	170	105	3
75 x 115	70	78	88	10 x M10	83	11,540	305	155	100	3.1
80 x 120	70	78	88	12 x M10	83	14,700	369	175	115	3.5
85 x 125	70	78	88	12 x M10	83	15,700	369	165	110	3.5
90 x 130	70	78	88	12 x M10	83	16,610	370	157	106	3.8
95 x 135	70	78	88	12 x M10	83	17,530	370	150	102	4
100 x 145	90	100	112	12 x M12	145	26,900	538	160	110	6
110 x 155	90	100	112	12 x M12	145	29,530	538	143	102	6.2
120 x 165	90	100	112	14 x M12	145	37,610	628	154	112	6.8
130 x 180	104	116	130	12 x M14	230	48,000	738	143	106	9.8
140 x 190	104	116	130	14 x M14	230	60,290	861	160	117	10.2
150 x 200	104	116	130	16 x M14	230	73,800	985	165	125	10.9
160 x 210	104	116	130	16 x M14	230	78,770	983	155	118	11.5
170 x 225	134	146	162	14 x M16	355	101,730	1,197	140	108	17.2
180 x 235	134	146	162	16 x M16	355	123,200	1,369	150	115	18
190 x 250	134	146	162	16 x M16	355	129,880	1,368	141	110	21.5
200 x 260	134	146	162	16 x M16	355	136,840	1,368	137	104	22
220 x 285	134	146	162	20 x M16	355	188,000	1,710	155	120	25
240 x 305	134	146	162	22 x M16	355	225,000	1,880	155	120	27
260 x 325	134	146	162	22 x M16	355	244,000	1,880	155	115	30
280 x 355	165	177	197	20 x M20	690	373,000	2,670	145	120	46
300 x 375	165	177	197	22 x M20	690	440,000	2,930	155	125	50
320 x 405	165	177	197	22 x M20	690	470,000	2,930	145	115	60
340 x 425	165	177	197	24 x M20	690	544,000	3,200	150	120	65
360 x 455	190	202	224	22 x M22	930	658,000	3,650	140	110	89
380 x 475	190	202	224	26 x M22	930	821,000	4,320	160	130	93
400 x 495	190	202	224	26 x M22	930	864,000	4,320	150	120	98

Other sizes, inch dimensions and individual versions on request. N.B. It is possible to reduce the screw tightening torque M_s to 60% of the value indicated on the dimension sheet. The values of M_T, F_A, p_w and p_N then decrease proportionally.

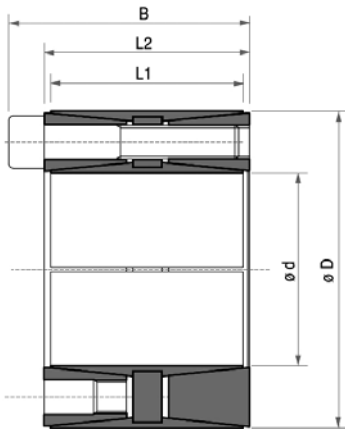



Clamping sets

TLK 401 self-centering – no axial movement during mounting
 TLK 401.0 self-centering – no axial movement during mounting

Dimensions				Clamping screws DIN 912 12.9	TLK 401					TLK 401.0					Weight TLK 401 TLK 401.0 [kg]
					Tightening torque	Torque	Axial force	Surface pressure on		Tightening torque	Torque	Axial force	Surface pressure on		
								Shaft	Hub				Shaft	Hub	
dxD [mm]	L1 [mm]	L2 [mm]	B [mm]	Number x type	M _s [Nm]	M _T [Nm]	F _A [kN]	p _w [N/mm ²]	p _N [N/mm ²]	M _s [Nm]	M _T [Nm]	F _A [kN]	p _w [N/mm ²]	p _N [N/mm ²]	
70 x 110	50	58	68	8 x M10	49	5,100	145	112	71	83	8,620	245	190	120	2.3
75 x 115	50	58	68	8 x M10	49	5,420	145	103	68	83	9,160	245	174	115	2.4
80 x 120	50	58	68	8 x M10	49	5,820	145	97	65	83	9,840	245	164	110	2.5
85 x 125	50	58	68	10 x M10	49	7,700	182	114	77	83	13,000	307	193	130	2.6
90 x 130	50	58	68	10 x M10	49	8,100	182	107	74	83	13,700	307	181	125	2.7
95 x 135	50	58	68	10 x M10	49	8,600	182	102	72	83	14,540	307	173	122	2.8
100 x 145	60	70	80	10 x M10	49	9,100	182	80	55	83	15,380	307	135	93	4
110 x 155	60	70	80	10 x M10	49	10,000	182	75	52	83	16,900	307	127	88	4.5
120 x 165	60	70	80	12 x M10	49	13,100	218	80	59	83	22,150	365	135	100	4.8
130 x 180	68	80	92	12 x M12	86	20,700	319	95	69	145	34,860	537	160	116	6.3
140 x 190	68	80	92	12 x M12	86	22,300	319	89	66	145	37,550	537	150	111	6.6
150 x 200	68	80	92	12 x M12	86	23,900	319	83	62	145	40,250	537	140	105	7
160 x 210	68	80	92	14 x M12	86	29,800	372	90	69	145	50,180	626	152	116	7.4
170 x 225	75	87	99	16 x M12	86	36,200	426	89	67	145	60,960	717	150	113	10
180 x 235	75	87	99	16 x M12	86	38,300	426	84	64	145	64,500	717	142	108	11.3
190 x 250	88	100	112	18 x M12	86	45,500	479	76	58	145	76,620	806	128	98	14
200 x 260	88	100	112	18 x M12	86	47,900	479	72	56	145	80,660	806	122	95	15.2
220 x 285	98	110	124	14 x M14	135	56,200	511	63	49	230	94,730	861	107	83	19.5
240 x 305	98	110	124	18 x M14	135	78,800	657	74	58	230	132,830	1,100	125	98	21.5
260 x 325	98	110	124	20 x M14	135	94,900	730	76	61	230	159,970	1,230	128	103	23
280 x 355	120	132	148	20 x M16	210	142,000	1015	80	63	355	239,260	1,710	135	106	29
300 x 375	120	132	148	24 x M16	210	182,000	1218	89	72	355	306,650	2,050	150	121	30.5
320 x 405	135	147	163	24 x M16	210	194,000	1218	75	60	355	326,870	2,050	127	101	47
340 x 425	135	147	163	24 x M16	210	207,000	1218	71	57	355	348,780	2,050	120	96	50

Other sizes, inch dimensions and individual versions on request.

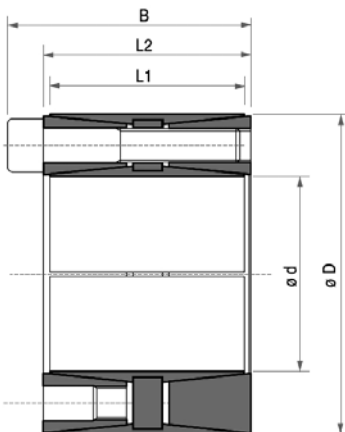

Clamping sets

TLK 450 self-centering – axial movement during mounting



Features

- For very high torques
- Absorption of bending torques (Please consult our technicians)
- Standard dimensions
- Self-centering
- With axial movement during mounting

Mounting:

Clean and lightly oil the contact surfaces of shaft and hub. Insert clamping set into seat of hub and push onto the shaft. Tighten the clamping screws in steps crosswise with a torque wrench until 50% of the indicated tightening torque M_s is reached. Then repeat the process with the full tightening torque. Starting with the last tightened screw and proceeding in a clockwise direction, check that all the clamping screws have been tightened with the correct tightening torque M_s . This concludes the mounting process. If the clamping screws are to be capable of being undone manually, they can be pretensioned with 60% of the indicated tightening torque. The values of M_T and F_A indicated in the table have been calculated for mounting with oil.

N.B.: Do not use oil containing molybdenum disulphide or extreme-pressure additives and do not use grease. The coefficient of friction would otherwise be considerably reduced.

Dismantling:

Unscrew clamping screws and insert into the dismantling threads of the front conical ring. Tighten screws in steps crosswise and uniformly with 50% of the tightening torque. Repeat the process with the full tightening torque. If the front conical ring becomes detached, tighten the screws further and repeat the process as described above in order to release the rear conical ring.

Tolerances, roughness depth:

A machine turned finish is sufficient.

Maximum permissible tolerances:

h8 for the shaft

H8 for the hub

Maximum roughness depth: R_t max. 16 μm (R_a 3 μm – R_z 13 μm)

How the minimum hub diameter is calculated is shown on page 12. We will be happy to advise you with regard to individual dimensioning and any other questions you may have.

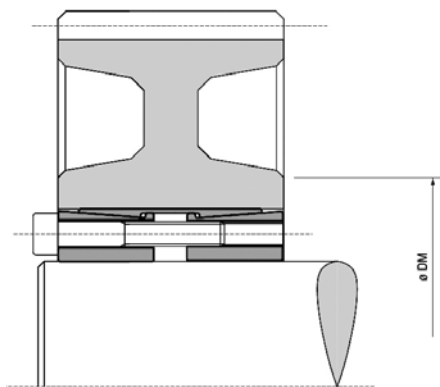



Clamping sets

TLK 450 self-centering – axial movement during mounting

Dimensions				Clamping screws		Torque	Axial force	Surface pressure		Weight
				Number DIN 912 12.9	Tightening torque			Shaft	Hub	
dxD [mm]	L1 [mm]	L2 [mm]	B [mm]	Number x type	M _s [Nm]	M _t [Nm]	F _A [kN]	P _w [N/mm ²]	P _N [N/mm ²]	[kg]
25 x 50	39	45	51	8 x M6	17	950	76	245	122	0.5
28 x 55	39	45	51	8 x M6	17	1,070	76	219	111	0.6
30 x 55	39	45	51	8 x M6	17	1,150	76	204	111	0.6
35 x 60	39	45	51	8 x M6	17	1,340	76	175	102	0.7
38 x 65	39	45	51	8 x M6	17	1,450	76	161	94	0.7
40 x 65	39	45	51	8 x M6	17	1,530	76	153	94	0.7
42 x 75	56	64	72	8 x M8	41	2,970	141	188	105	1
45 x 75	56	64	72	8 x M8	41	3,150	141	175	105	0.9
48 x 80	56	64	72	8 x M8	41	4,000	166	164	98	1.4
50 x 80	56	64	72	8 x M8	41	4,150	166	158	98	1.3
55 x 85	56	64	72	8 x M8	41	4,550	166	143	93	1.5
60 x 90	56	64	72	10 x M8	41	6,200	207	164	109	1.6
65 x 95	56	64	72	10 x M8	41	6,750	207	152	104	1.8
70 x 110	70	78	88	10 x M10	83	11,550	330	179	114	3
75 x 115	70	78	88	10 x M10	83	12,350	330	167	109	3.3
80 x 120	70	78	88	12 x M10	83	15,800	396	188	125	3.5
85 x 125	70	78	88	12 x M10	83	16,800	396	177	120	3.7
90 x 130	70	78	88	12 x M10	83	17,800	396	167	115	3.8
95 x 135	70	78	88	12 x M10	83	18,800	396	158	111	5
100 x 145	90	100	112	12 x M12	145	28,800	576	170	117	6
110 x 155	90	100	112	12 x M12	145	31,700	576	155	110	6.2
120 x 165	90	100	112	14 x M12	145	40,300	673	165	120	7.2
130 x 180	104	116	130	12 x M14	230	51,400	791	155	112	10
140 x 190	104	116	130	14 x M14	230	64,600	923	168	124	10.2
150 x 200	104	116	130	16 x M14	230	79,100	1,055	179	135	10.8
160 x 210	104	116	130	16 x M14	230	84,400	1,055	168	128	11.5
170 x 225	134	146	162	14 x M16	355	109,000	1,283	149	113	17
180 x 235	134	146	162	16 x M16	355	132,000	1,466	161	124	18.5
190 x 250	134	146	162	16 x M16	355	139,000	1,466	153	116	21.5
200 x 260	134	146	162	16 x M16	355	146,500	1,466	145	112	22
220 x 285	134	146	162	20 x M16	355	201,500	1,833	165	127	25
240 x 305	134	146	162	22 x M16	355	242,000	2,017	166	131	27
260 x 325	134	146	162	22 x M16	355	262,000	2,017	154	123	30
280 x 355	165	177	197	20 x M20	690	400,000	2,862	164	130	46
300 x 375	165	177	197	22 x M20	690	472,000	3,148	169	135	50
320 x 405	165	177	197	22 x M20	690	503,500	3,148	158	125	60
340 x 425	165	177	197	24 x M20	690	583,500	3,434	162	130	65
360 x 455	190	202	224	22 x M22	930	705,000	3,918	152	120	89
380 x 475	190	202	224	26 x M22	930	880,000	4,631	170	136	93
400 x 495	190	202	224	26 x M22	930	926,000	4,631	162	131	98

Other sizes, inch dimensions and individual versions on request. N.B. It is possible to reduce the screw tightening torque M_s to 60% of the value indicated on the dimension sheet. The values of M_t, F_A, P_w and P_N then decrease proportionally.

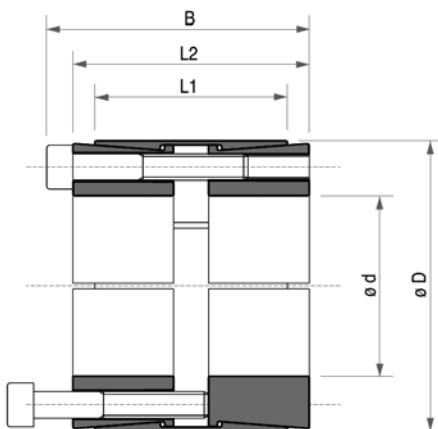

Clamping sets

TLK 451/TLK 451.0 self-centering – axial movement during mounting



Features

- For very high torques
- Absorption of bending torques (Please consult our technicians)
- Standard dimensions
- Self-centering
- With axial movement during mounting

Mounting:

Clean and lightly oil the contact surfaces of shaft and hub. Insert clamping set into seat of hub and push onto the shaft. Tighten the clamping screws in steps crosswise with a torque wrench until 50% of the indicated tightening torque M_s is reached. Then repeat the process with the full tightening torque. Starting with the last tightened screw and proceeding in a clockwise direction, check that all the clamping screws have been tightened with the correct tightening torque M_s . This concludes the mounting process. If the clamping screws are to be capable of being undone manually, they can be pretensioned with 60% of the indicated tightening torque. The values of M_T and F_A indicated in the table have been calculated for mounting with oil.

N.B.: Do not use oil containing molybdenum disulphide or extreme-pressure additives and do not use grease. The coefficient of friction would otherwise be considerably reduced.

Dismantling:

Unscrew clamping screws and insert into the dismantling threads of the front conical ring. Tighten screws in steps crosswise and uniformly with 50% of the tightening torque. Repeat the process with the full tightening torque. If the front conical ring becomes detached, tighten the screws further and repeat the process as described above in order to release the rear conical ring.

N.B.: If, after dismantling, the clamping set TLK 451/TLK 451.0 is to be mounted again, it must be ensured that the dismantling threads of the front conical ring and the connection flange are in their original position.

Tolerances, roughness depth:

A machine turned finish is sufficient.

Maximum permissible tolerances:

h8 for the shaft

H8 for the hub

Maximum roughness depth: R_t max. 16 μm (R_a 3 μm – R_z 13 μm)

How the minimum hub diameter is calculated is shown on page 12. We will be happy to advise you with regard to individual dimensioning and any other questions you may have.

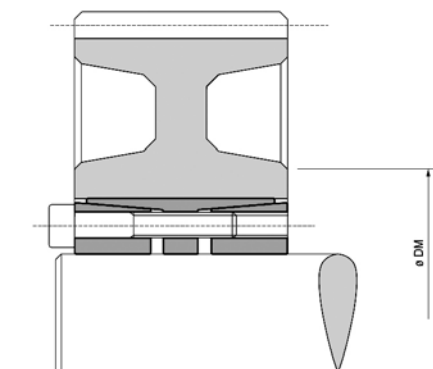



Clamping sets

TLK 451/TLK 451.0 self-centering – axial movement during mounting

Dimensions				Clamping screws DIN 912 12.9	TLK 451						TLK 451.0					
					Tightening torque	Torque	Axial force	Surface pressure on		Tightening torque	Torque	Axial force	Surface pressure on		Weight TLK 451 TLK 451.0	
								Shaft	Hub				Shaft	Hub		
dxD [mm]	L1 [mm]	L2 [mm]	B [mm]	Number x type	M _s [Nm]	M _t [Nm]	F _A [kN]	p _w [N/mm ²]	p _N [N/mm ²]	M _s [Nm]	M _t [Nm]	F _A [kN]	p _w [N/mm ²]	p _N [N/mm ²]	[kg]	
70 x 110	50	60	70	8 x M10	49	4,180	120	113	64	83	7,090	203	192	109	2.3	
80 x 120	50	60	70	10 x M10	49	5,980	150	124	73	83	10,130	253	210	124	2.5	
90 x 130	50	60	70	11xM10	49	7,400	165	121	75	83	12,540	279	205	126	2.7	
100 x 145	60	70	82	10 x M12	86	10,930	219	121	74	145	18,440	369	204	125	4.1	
110 x 155	60	70	82	10 x M12	86	12,000	219	110	69	145	20,200	369	185	117	4.4	
120 x 165	60	70	82	11 x M12	86	14,400	241	111	72	145	24,300	406	187	121	4.8	
130 x 180	65	79	91	14 x M12	86	19,900	306	118	77	145	33,500	516	199	129	6.3	
140 x 190	65	79	91	15 x M12	86	22,900	328	117	78	145	38,700	553	198	131	6.6	
150 x 200	65	79	91	15 x M12	86	24,600	328	110	74	145	41,400	553	185	124	7.8	
160 x 210	65	79	91	16 x M12	86	28,000	350	110	75	145	47,200	590	185	126	7.4	
170 x 225	78	92	106	15 x M14	135	37,800	446	109	74	230	64,500	759	185	126	10.7	
180 x 235	78	92	106	15 x M14	135	40,100	446	103	71	230	68,300	759	175	121	11.3	
190 x 250	88	102	116	16 x M14	135	45,100	475	90	62	230	76,900	810	153	106	14.6	
200 x 260	88	102	116	18 x M14	135	53,400	535	96	67	230	91,100	911	163	115	15.3	
220 x 285	96	108	124	15 x M16	210	68,600	624	94	66	355	116,000	1,055	159	112	20.2	
240 x 305	96	108	124	20 x M16	210	99,800	832	115	82	355	168,800	1,407	194	139	21.8	
260 x 325	96	108	124	20 x M16	210	108,000	832	106	77	355	182,000	1,407	179	130	23.4	
280 x 355	96	110	130	15 x M20	410	137,000	979	122	85	690	230,000	1,647	205	143	30	
300 x 375	96	110	130	16 x M20	410	156,000	1,044	121	86	690	263,000	1,757	204	145	31.2	
320 x 405	124	136	156	20 x M20	410	208,000	1,305	104	75	690	351,000	2,196	175	126	48	
340 x 425	124	136	156	20 x M20	410	221,000	1,305	98	71	690	373,000	2,196	165	120	51	
360 x 455	140	155	177	20 x M22	550	291,000	1,617	101	73	930	492,000	2,734	171	124	69	
380 x 475	140	155	177	20 x M22	550	307,000	1,617	96	70	930	519,000	2,734	162	118	73	
400 x 495	140	155	177	22 x M22	550	355,000	1,778	100	74	930	601,000	3,007	169	125	76	
420 x 515	140	155	177	24 x M22	550	407,000	1,940	104	77	930	688,000	3,280	176	131	80	
440 x 535	140	155	177	24 x M22	550	426,000	1,940	99	75	930	721,000	3,280	168	126	81	
460 x 555	140	155	177	24 x M22	550	446,000	1,940	95	72	930	754,000	3,280	160	122	85	
480 x 575	140	155	177	25 x M22	550	485,000	2,021	95	72	930	820,000	3,417	160	122	88	
500 x 595	140	155	177	25 x M22	550	505,000	2,021	91	70	930	854,000	3,417	154	118	91	
520 x 615	140	155	177	28 x M22	550	588,000	2,263	98	76	930	995,000	3,827	165	128	95	
540 x 635	140	155	177	28 x M22	550	611,000	2,263	94	73	930	1,033,000	3,827	159	124	98	
560 x 655	140	155	177	30 x M22	550	679,000	2,425	97	76	930	1,148,000	4,101	165	129	101	
580 x 675	140	155	177	30 x M22	550	703,000	2,425	94	74	930	1,189,000	4,101	159	125	104	
600 x 695	140	155	177	30 x M22	550	727,000	2,425	91	72	930	1,230,000	4,101	154	121	108	

Other sizes, inch dimensions and individual versions on request.

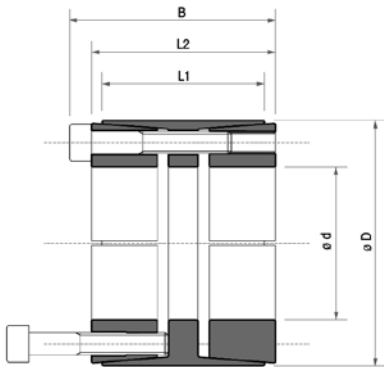

Clamping sets

TLK 452 self-centering – axial movement during mounting



Features

- For very high torques
- Absorption of bending torques (Please consult our technicians)
- Standard dimensions
- Self-centering
- With axial movement during mounting

Mounting:

Clean and lightly oil the contact surfaces of shaft and hub. Insert clamping set into seat of hub and push onto the shaft. Tighten the clamping screws in steps crosswise with a torque wrench until 50% of the indicated tightening torque M_s is reached. Then repeat the process with the full tightening torque. Starting with the last tightened screw and proceeding in a clockwise direction, check that all the clamping screws have been tightened with the correct tightening torque M_s . This concludes the mounting process. If the clamping screws are to be capable of being undone manually, they can be pretensioned with 60% of the indicated tightening torque. The values of M_T and F_A indicated in the table have been calculated for mounting with oil.

N.B.: Do not use oil containing molybdenum disulphide or extreme-pressure additives and do not use grease. The coefficient of friction would otherwise be considerably reduced.

Dismantling:

Unscrew clamping screws and insert into the dismantling threads of the front conical ring. Tighten screws in steps crosswise and uniformly with 50% of the tightening torque. Repeat the process with the full tightening torque. If the front conical ring becomes detached, tighten the screws further and repeat the process as described above in order to release the rear conical ring.

N.B.: If, after dismantling, the clamping set TLK 452 is to be mounted again, it must be ensured that the dismantling windings of the front conical rings and the connection flange are in their original position.

Tolerances, roughness depth:

A machine turned finish is sufficient.

Maximum permissible tolerances:

h8 for the shaft

H8 for the hub

Maximum roughness depth: R_t max. 16 μm (R_a 3 μm – R_z 13 μm)

How the minimum hub diameter is calculated is shown on page 12. We will be happy to advise you with regard to individual dimensioning and any other questions you may have.

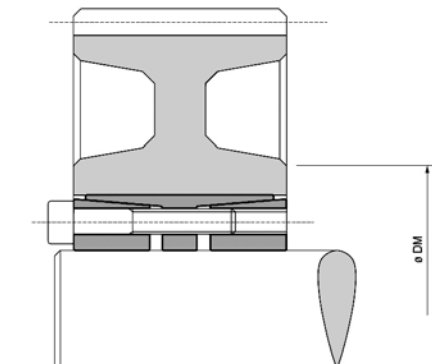



Clamping sets

TLK 452 self-centering – axial movement during mounting

Dimensions				Clamping screws		Torque	Axial force	Surface pressure		Weight
				Number DIN 912 12.9	Tightening torque			Shaft	Hub	
dxD [mm]	L1 [mm]	L2 [mm]	B [mm]	Number x type	M _s [Nm]	M _T [Nm]	F _A [kN]	P _w [N/mm ²]	P _N [N/mm ²]	[kg]
25 x 55	32	40	46	6 x M6	17	860	69	307	105	0.5
28 x 55	32	40	46	6 x M6	17	970	69	274	105	0.4
30 x 55	32	40	46	6 x M6	17	1,040	69	256	105	0.4
35 x 60	44	54	60	7 x M6	17	1,410	81	180	81	0.6
38 x 75	44	54	62	7 x M8	41	2,840	150	307	120	1.1
40 x 75	44	54	62	7 x M8	41	2,990	150	292	120	1.1
42 x 75	44	54	62	7 x M8	41	3,140	150	278	120	1
45 x 75	44	54	62	7 x M8	41	3,360	150	259	120	1
48 x 80	56	64	72	8 x M8	41	4,100	171	205	101	1.4
50 x 80	56	64	72	8 x M8	41	4,270	171	197	101	1.3
55 x 85	56	64	72	9 x M8	41	5,280	192	202	107	1.4
60 x 90	56	64	72	10 x M8	41	6,410	214	205	112	1.5
65 x 95	56	64	72	10 x M8	41	6,940	214	190	107	1.6
70 x 110	70	78	88	10 x M10	83	11,800	339	222	117	3.1
75 x 115	70	78	88	10 x M10	83	12,700	339	207	112	3.3
80 x 120	70	78	88	11 x M10	83	14,900	373	213	118	3.4
85 x 125	70	78	88	12 x M10	83	17,300	407	219	123	3.6
90 x 130	70	78	88	12 x M10	83	18,300	407	207	119	3.8
95 x 135	70	78	88	12 x M10	83	19,300	407	196	114	3.9
100 x 145	90	100	112	11 x M12	145	27,100	544	206	110	6.1
110 x 155	90	100	112	12 x M12	145	32,600	593	204	113	6.6
120 x 165	90	100	112	14 x M12	145	41,500	692	218	124	7,1
130 x 180	104	116	130	12 x M14	230	52,800	814	198	115	10
140 x 190	104	116	130	14 x M14	230	66,400	949	214	127	11
150 x 200	104	116	130	15 x M14	230	76,200	1,017	214	130	11
160 x 210	104	116	130	16 x M14	230	86,700	1,085	214	132	12
170 x 225	134	148	164	14 x M16	360	112,000	1,319	196	116	18
180 x 235	134	148	164	15 x M16	360	127,000	1,413	198	119	19
190 x 250	134	148	164	16 x M16	360	143,000	1,508	200	119	22
200 x 260	134	148	164	16 x M16	360	150,000	1,508	190	115	23
220 x 285	134	148	164	18 x M16	360	186,000	1,696	195	118	27
240 x 305	134	150	166	20 x M16	360	226,000	1,885	198	122	29
260 x 325	134	150	166	21 x M16	360	257,000	1,979	192	121	31
280 x 355	165	177	197	18 x M20	690	370,000	2,648	197	120	48
300 x 375	165	177	197	20 x M20	690	441,000	2,942	205	126	51
320 x 405	165	177	197	21 x M20	690	494,000	3,089	202	123	62
340 x 425	165	177	197	22 x M20	690	550,000	3,236	199	122	66
360 x 455	190	202	224	21 x M22	930	692,000	3,845	193	118	90
380 x 475	190	202	224	22 x M22	930	765,000	4,028	191	118	95
400 x 495	190	202	224	24 x M22	930	878,000	4,394	198	124	99

Other sizes, inch dimensions and individual versions on request. N.B. It is possible to reduce the screw tightening torque M_s to 60% of the value indicated on the dimension sheet. The values of M_T, F_A, P_w and p_N then decrease proportionally.

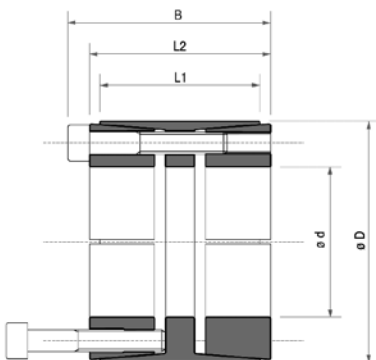

Rigid shaft couplings

TLK 500 self-centering – no axial movement during mounting



Features

- For medium to high torques
- Small number of screws
- Quick mounting
- Self-centering
- No axial movement during mounting

Mounting:

Clean and lightly oil the contact surfaces of the shafts. Place rigid coupling onto the connecting shafts. Gradually tighten clamping screws in steps crosswise to the indicated tightening torque M_s . The values of M_t and F_A in the table have been calculated for mounting with oil.

N.B.: Do not use oil containing molybdenum disulphide or extreme-pressure additives and do not use grease. The coefficient of friction would otherwise be considerably reduced.

Dismantling:

Undo and remove all clamping screws. As a rule, the coupling becomes detached automatically. Otherwise, hit lightly with a hammer on the loosened screw heads in order to push the rear conical ring back.

Tolerances, roughness depth:

A machine turned finish is sufficient.

Maximum permissible tolerances:

h8 for the shaft

Maximum roughness depth: R_t max. 16 μm (R_a 3 μm – R_z 13 μm)

We will be happy to advise you with regard to individual dimensioning and any other questions you may have.

Dimensions			Torque	Axial force	Clamping screws		Weight
dxD [mm]	L [mm]	B [mm]			Number DIN 912 12.9	Tightening torque	
			M_t [Nm]	F_A [kN]	Number x type	M_s [Nm]	[kg]
17 x 50	50	56	200	24	4 x M6	17	0.5
18 x 50	50	56	220	24	4 x M6	17	0.5
19 x 50	50	56	230	24	4 x M6	17	0.5
20 x 50	50	56	240	24	4 x M6	17	0.5
22 x 55	60	66	260	24	4 x M6	17	0.6
24 x 55	60	66	290	24	4 x M6	17	0.6
25 x 55	60	66	450	36	6 x M6	17	0.6
28 x 60	60	66	510	36	6 x M6	17	0.7
30 x 60	60	66	550	36	6 x M6	17	0.7
32 x 75	60	68	720	45	4 x M8	41	1.3
35 x 75	75	83	790	45	4 x M8	41	1.3
38 x 75	75	83	850	45	4 x M8	41	1.3
40 x 75	75	83	900	45	4 x M8	41	1.3
42 x 90	75	83	1,400	67	6 x M8	41	2.8
45 x 90	85	93	1,520	67	6 x M8	41	2.5
48 x 90	85	93	1,620	67	6 x M8	41	2.4
50 x 90	85	93	1,690	67	6 x M8	41	2.3
55 x 105	85	93	2,470	90	8 x M8	41	3.3
60 x 105	85	93	2,710	90	8 x M8	41	3.2
65 x 105	85	93	2,930	90	8 x M8	41	3
70 x 125	100	110	3,770	107	6 x M10	83	5.4
75 x 125	100	110	4,030	107	6 x M10	83	5
80 x 125	100	110	4,300	107	6 x M10	83	4.7

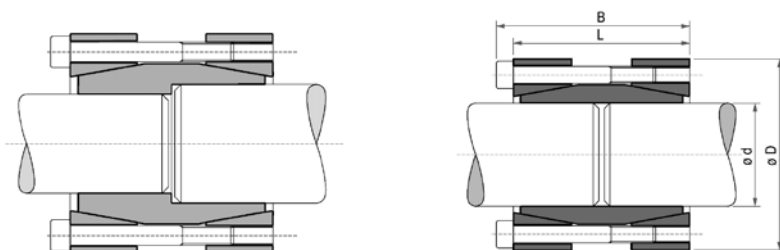



Shrink discs

TLK 603 – Standard series, TLK 602 – Heavy series, TLK 601 – Light series
self-centering – no axial movement during mounting

Features

- For medium to high torques
- Short mounting times
- Self-centering
- Without axial movement during mounting

Mounting:

Clean contact surfaces of shaft and hub. Push the shrink discs onto the hollow shaft. Gradually tighten the clamping screws to the indicated tightening torque M_s in a clockwise direction with a torque wrench. Several screwing processes are necessary in order to reach the indicated tightening torque.

N.B.: Do not use oil containing molybdenum disulphide or extreme-pressure additives and do not use grease. The coefficient of friction would otherwise be considerably reduced.

Dismantling:

Unscrew all clamping screws uniformly in a clockwise direction but do not screw them completely out of the thread. The shrink discs usually come loose automatically. If the shrink discs are to be used again, lubricating grease must be applied to the screws and the conical surfaces. The lubricating grease must guarantee a coefficient of friction of 0.04.

Tolerances, roughness depth:

A machine turned finish is sufficient.

Maximum permissible tolerances:

h8 für for the outer diameter of the hollow shaft (catalogue value d)

Maximum roughness depth: R_t max. 16 μm (R_a 3 μm – R_z 13 μm)

Tolerances for shaft diameter d_w :

H6/j6 for shaft diameters of 18 mm to 30 mm

H6/h6 for shaft diameters greater than 30 mm to 50 mm

H6/g6 for shaft diameters greater than 50 mm to 80 mm

H7/g6 for shaft diameters greater than 80 mm to 500 mm

We will be happy to advise you with regard to individual dimensioning and any other questions you may have.

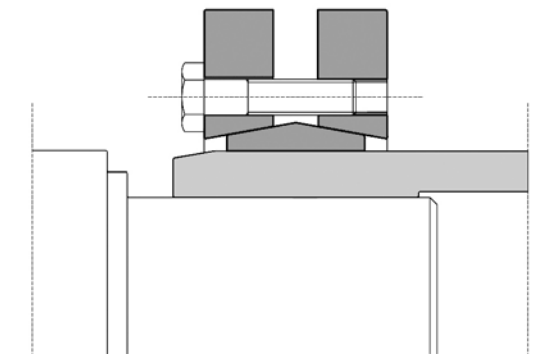

Shrink discs

TLK 603 self-centering – no axial movement during mounting – Standard series



Type	Shaft diameter	Torque	Axial force	Dimensions					Clamping screws		Weight
									Type DIN 931 10.9	Tightening torque	
d1 [mm]	d _w [mm]	M _t [Nm]	F _a [kN]	D [mm]	l [mm]	L [mm]	d1 [mm]	e [mm]	Number x type	M _s [Nm]	[kg]
14	11	30	6	38	7	11	23	2	4 x M5*	4	0.1
	12	50	9								
16	13	70	10	41	11	15	26	2	5 x M5*	4	0.1
	14	90	13								
24	19	170	25	50	14	19.5	36	2.75	6 x M5*	4	0.2
	20	210	27								
	21	250	29								
30	24	300	29	60	16	21.5	44	2.75	7 x M5*	4	0.3
	25	340	31								
	26	380	33								
36	28	440	50	72	18	23.5	52	2.75	5 x M6	12	0.4
	30	570	58								
	31	630	58								
44	32	620	64	80	20	25.5	61	2.75	7 x M6	12	0.6
	35	780	74								
	36	860	77								
50	38	940	79	90	22	27.5	70	2.75	8 x M6	12	0.8
	40	1,160	86								
	42	1,380	92								
55	42	1,160	79	100	23	30.5	75	3.75	8 x M6	12	1.1
	45	1,520	88								
	48	1,880	97								
62	48	1,850	100	110	23	30.5	86	3.75	10 x M6	12	1.3
	50	2,200	111								
	52	2,400	117								
68	50	2,000	97	115	23	30.5	86	3.75	10 x M6	12	1.4
	55	2,500	106								
	60	3,150	120								
75	55	2,500	119	138	25	32.5	100	3.75	7 x M8	30	1.7
	60	3,200	137								
	65	3,950	155								
80	60	3,200	124	145	25	32.5	100	3.75	7 x M8	30	1.9
	65	3,900	140								
	70	4,600	158								
85	65	4,800	175	155	30	39	114	4.5	10 x M8	30	3.5
	70	6,100	195								
	75	7,400	216								
90	65	4,750	170	155	30	39	114	4.5	10 x M8	30	3.3
	70	6,000	190								
	75	7,250	210								
100	70	6,900	195	170	34	44	124	5	12 x M8	30	4,7
	75	7,500	220								
	80	9,000	240								
110	75	7,200	229	185	39	50	136	5.5	9 x M10	59	5.9
	80	9,000	252								
	85	10,800	262								
115	80	7,400	235	188	39	50	141	5.5	9 x M10	59	5.5
	85	9,200	259								
	90	11,100	269								
120	80	10,600	285	215	42	54	160	6	12 x M10	59	9
	85	13,300	314								
	90	14,500	340								
125	85	11,000	296	215	42	54	160	6	12 x M10	59	8.3
	90	13,000	324								
	95	15,000	352								
130	90	11,300	304	215	42	54	160	6	12 x M10	59	8
	95	13,300	333								
	100	15,400	362								
140	95	15,100	367	230	46	60.5	175	7.25	10 x M12	100	10
	100	17,600	396								
	105	20,100	425								
155	105	22,000	447	265	50	64.5	192	7.25	12 x M12	100	15
	110	25,000	478								
	115	28,000	509								
160	110	22,600	460	265	50	64.5	192	7.25	12 x M12	100	14.5
	115	25,700	490								
	120	28,800	520								
165	115	31,000	595	290	56	71	210	7.5	8 x M16	250	22
	120	35,000	630								
	125	39,000	655								

* Screw quality 8.8

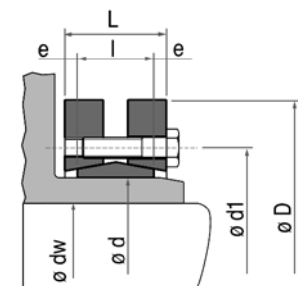



Shrink discs

TLK 603 self-centering – no axial movement during mounting – Standard series

Type	Shaft diameter	Torque	Axial force	Dimensions					Clamping screws		Weight
									Type DIN 931 10.9	Tightening torque	
d1 [mm]	d _w [mm]	M _t [Nm]	F _a [kN]	D [mm]	l [mm]	L [mm]	d1 [mm]	e [mm]	Number x type	M _s [Nm]	[kg]
170	120	31,900	610	290	56	71	210	7.5	8 x M16	250	21
	125	36,000	640								
	130	40,100	670								
175	125	36,000	605	300	56	71	220	7.5	8 x M16	250	22
	130	41,000	639								
	135	45,000	675								
180	130	37,000	800	300	56	71	220	7.5	8 x M16	250	21
	135	42,200	840								
	140	46,300	885								
185	135	52,000	778	330	71	86	236	7.5	10 x M16	250	37
	140	57,000	819								
	145	62,000	861								
190	140	53,500	800	330	71	86	236	7.5	10 x M16	250	36
	145	58,700	840								
	150	63,800	885								
195	140	65,000	933	350	71	86	246	7.5	12 x M16	250	41
	150	76,000	1,025								
	155	81,500	1,071								
200	150	74,000	990	350	71	86	246	7.5	12 x M16	250	41
	155	80,000	1,035								
	160	86,000	1,080								
220	160	95,000	1,190	370	88	104	270	8	15 x M16	250	54
	165	102,000	1,239								
	170	110,000	1,290								
240	170	120,000	1,464	405	92	109	295	8.5	12 x M20	490	67
	180	138,000	1,576								
	190	156,000	1,675								
260	190	164,000	1,760	430	103	120	321	8.5	14 x M20	490	82
	200	184,000	1,880								
	210	205,000	2,010								
280	210	217,000	2,090	460	114	134	346	10	16 x M20	490	102
	220	244,000	2,220								
	230	270,000	2,350								
300	230	275,000	2,431	485	122	142	364	10	18 x M20	490	118
	240	295,000	2,567								
	245	315,000	2,636								
320	240	312,000	2,647	520	122	142	386	10	20 x M20	490	131
	250	340,000	2,786								
	260	374,000	2,900								
340	250	390,000	3,119	570	134	156	408	11	24 x M20	490	186
	260	422,500	3,249								
	270	460,000	3,400								
350	270	442,000	3,276	580	140	162	432	11	24 x M20	490	195
	280	480,000	3,430								
	285	500,000	3,500								
360	280	463,000	3,310	590	140	162	432	11	24 x M20	490	204
	290	502,000	3,461								
	295	522,000	3,536								
380	290	567,000	3,910	645	144	168	458	12	20 x M24	840	239
	300	610,000	4,080								
	310	658,000	4,248								
390	300	624,000	4,160	660	144	168	468	12	21 x M24	840	260
	310	671,000	4,330								
	320	718,000	4,484								
400	315	670,000	4,260	680	144	168	480	12	21 x M24	840	280
	320	695,000	4,345								
	330	744,000	4,500								
420	330	780,000	4,850	690	164	188	504	12	24 x M24	840	316
	340	840,000	5,040								
	350	900,000	5,220								
440	340	806,000	4,740	750	177	202	527	12.5	24 x M24	840	408
	350	860,000	4,910								
	360	917,000	5,090								
460	360	1,000,000	5,670	770	177	202	547	12.5	28 x M24	840	420
	370	1,070,000	5,860								
	380	1,140,000	6,050								
480	380	1,170,000	6,150	800	188	213	570	12.5	30 x M24	840	505
	390	1,240,000	6,350								
	400	1,310,000	6,550								

Other sizes, inch dimensions and individual versions on request.

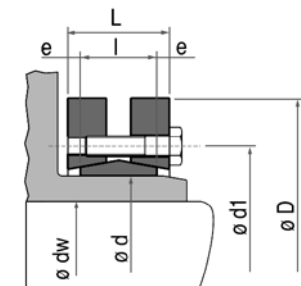

Shrink discs

TLK 602 self-centering – no axial movement during mounting – Heavy series



Type	Shaft diameter	Torque	Axial force	Dimensions					Clamping screws		Weight
									Type DIN 931 10.9	Tightening torque	
d1 [mm]	d _w [mm]	M _t [Nm]	F _a [kN]	D [mm]	l [mm]	L [mm]	d1 [mm]	e [mm]	Number x type	M _s [Nm]	[kg]
125	85	15,000	355	215	55	65	160	5	10 x M12	100	11
	90	17,500	388								
	95	20,000	422								
140	95	20,600	433	230	60	74	175	7	12 x M12	100	13
	100	23,500	469								
	105	26,500	500								
155	105	28,600	550	265	66	80	198	7	15 x M12	100	20
	110	32,500	590								
	115	36,400	630								
165	115	41,000	740	290	72	88	210	8	10 x M16	250	26
	120	46,000	785								
	125	50,700	815								
175	125	47,000	750	300	72	88	220	8	10 x M16	250	29
	130	52,000	795								
	135	57,000	840								
185	135	72,000	1,100	330	92	112	236	10	14 x M16	250	47
	140	78,000	1,150								
	145	86,000	1,200								
195	140	75,000	1,075	350	92	112	246	10	14 x M16	250	53
	150	88,000	1,180								
	155	96,000	1,235								
200	145	85,000	1,170	350	92	112	246	10	15 x M16	250	50
	150	92,500	1,230								
	155	100,000	1,290								
220	160	127,000	1,590	370	114	134	270	10	20 x M16	250	65
	165	136,000	1,650								
	170	146,500	1,720								
240	170	155,000	1,820	405	120	144	295	12	15 x M20	490	87
	180	176,000	1,960								
	190	198,000	2,080								
260	190	213,000	2,260	430	136	160	321	12	18 x M20	490	100
	200	240,000	2,420								
	210	268,000	2,580								
280	210	285,000	2,740	460	148	172	346	12	21 x M20	490	132
	220	320,000	2,910								
	230	355,000	3,090								
300	230	341,000	2,960	485	152	176	364	12	22 x M20	490	140
	240	376,000	3,130								
	245	394,000	3,215								
320	240	378,000	3,150	520	160	184	386	12	24 x M20	490	165
	250	415,000	3,325								
	260	451,000	3,470								
340	250	489,500	3,910	570	176	200	420	12	21 x M24	840	240
	260	530,000	4,075								
	270	578,000	4,275								
350	270	556,000	4,122	580	176	200	425	12	21 x M24	840	247
	280	604,000	4,320								
	285	629,000	4,415								
360	280	612,000	4,370	590	180	204	432	12	22 x M24	840	250
	290	663,000	4,570								
	295	689,000	4,670								
380	290	618,000	4,270	645	180	204	458	12	22 x M24	840	320
	300	668,000	4,455								
	310	719,000	4,645								
390	300	708,000	4,715	660	188	212	468	12	24 x M24	840	350
	310	762,000	4,910								
	320	814,500	5,090								
400	315	765,000	4,855	680	188	212	480	12	24 x M24	840	370
	320	788,000	4,927								
	330	845,000	5,125								
420	330	999,000	6,055	690	214	238	504	12	30 x M24	840	410
	340	1,068,000	6,285								
	350	1,140,000	6,515								
440	340	1,058,000	6,230	750	224	252	527	14	24 x M27	1250	525
	350	1,130,000	6,460								
	360	1,204,000	6,690								
460	360	1,320,000	7,440	770	224	252	547	14	28 x M27	1250	540
	370	1,420,000	7,700								
	380	1,500,000	7,950								

Other sizes, inch dimensions and individual versions on request.

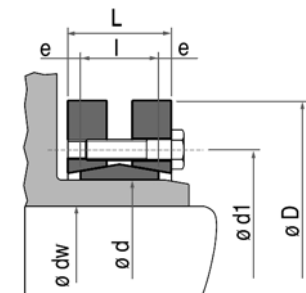



Shrink discs

TLK 601 self-centering – no axial movement during mounting – Light series

Type	Shaft diameter	Torque	Axial force	Dimensions					Clamping screws		Weight
									Type DIN 931 10.9	Tightening torque	
d1 [mm]	d _w [mm]	M _T [Nm]	F _A [kN]	D [mm]	l [mm]	L [mm]	d1 [mm]	e [mm]	Number x type	M _s [Nm]	[kg]
125	95	10,550	220	185	39	51	158	6	8 x M10	59	6
	100	12,100	240								
	105	13,800	260								
140	110	14,800	265	220	39	51	175	6	9 x M10	59	8
	120	18,640	310								
	125	20,500	325								
155	130	24,000	365	245	39	51	192	6	11 x M10	59	10
	135	26,400	390								
	140	29,000	410								
165	135	32,000	475	260	46	62	210	8	10 x M12	100	14
	140	35,200	500								
	145	38,500	530								
175	145	39,000	535	275	46	62	220	8	11 x M12	100	16
	150	42,400	560								
	155	46,000	590								
185	155	46,600	600	295	46	62	225	8	12 x M12	100	20
	160	50,300	625								
	165	54,000	650								
195	165	63,000	760	315	56	72	237	8	15 x M12	100	27
	170	67,700	795								
	175	72,500	825								
200	175	74,000	850	330	56	72	242	8	16 x M12	100	30
	180	79,500	890								
	185	84,500	915								
220	180	82,800	920	345	66	84	265	9	10 x M16	250	35
	190	93,500	980								
	200	105,000	1,055								
240	200	113,000	1,135	370	66	84	290	9	12 x M16	250	44
	210	127,500	1,210								
	215	134,500	1,250								
260	220	149,000	1,350	395	72	92	310	10	14 x M16	250	48
	230	165,000	1,435								
	235	173,000	1,475								
280	230	171,000	1,485	425	84	104	333	10	16 x M16	250	60
	240	189,000	1,570								
	250	208,000	1,660								
300	250	215,000	1,720	460	84	104	358	10	18 x M16	250	75
	260	234,000	1,800								
	270	255,000	1,890								
320	270	260,000	1,940	495	84	106	378	11	20 x M16	250	84
	280	284,000	2,030								
	290	306,000	2,125								
340	290	300,000	2,070	535	84	106	402	11	21 x M16	250	100
	300	324,400	2,160								
	305	337,000	2,210								
350	300	372,000	2,485	545	100	122	413	11	16 x M20	490	120
	305	385,000	2,540								
	310	400,000	2,590								
360	300	360,000	2,400	555	100	122	423	11	16 x M20	490	125
	310	388,000	2,500								
	320	415,000	2,590								
380	320	435,000	2,720	585	112	136	442	12	18 x M20	490	150
	325	451,000	2,780								
	330	467,000	2,835								
390	330	505,000	3,060	595	112	136	452	12	20 x M20	490	156
	340	540,000	3,175								
	350	577,000	3,295								
400	340	550,000	3,235	615	112	136	462	12	21 x M20	490	170
	350	587,000	3,360								
	360	626,000	3,480								
420	350	578,000	3,300	630	120	144	485	12	22 x M20	490	185
	360	617,000	3,425								
	370	655,000	3,545								
440	370	677,000	3,660	660	120	144	505	12	24 x M20	490	205
	380	719,000	3,785								
	390	762,000	3,910								
460	390	840,000	4,320	685	132	158	527	13	28 x M20	490	235
	400	890,000	4,460								
	410	935,000	4,580								

Other sizes, inch dimensions and individual versions on request.

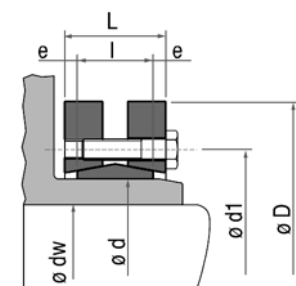

Shrink discs

Customised shrink disc solutions

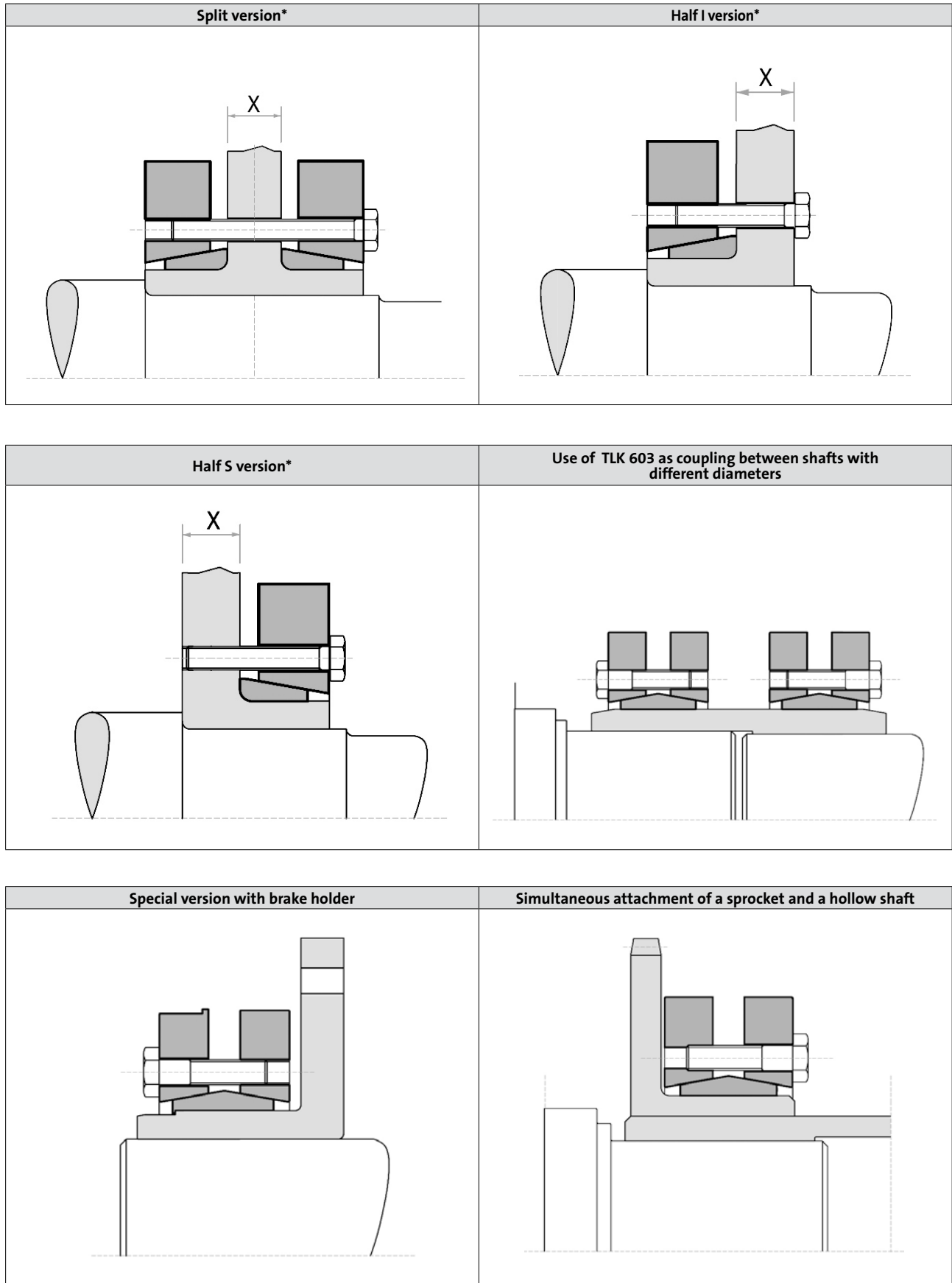

*When ordering, indicate dimension X



Shrink discs

TLK 622, TLK 623, TLK 681, TLK 683 self-centering –
no axial movement during mounting

Features

- For very high torques
- Short mounting times
- Self-centering
- Without axial movement during mounting

Mounting:

Clean contact surfaces of shaft and hub. Push the shrink discs onto the hollow shaft. Gradually tighten the clamping screws to the indicated tightening torque M_s in a clockwise direction with a torque wrench. Several screwing processes are necessary in order to reach the indicated tightening torque.

N.B.: Do not use oil containing molybdenum disulphide or extreme-pressure additives and do not use grease. The coefficient of friction would otherwise be considerably reduced.

Dismantling:

Unscrew all clamping screws uniformly in a clockwise direction but do not screw them completely out of the thread. The shrink discs usually come loose automatically. If the shrink discs are to be used again, lubricating grease must be applied to the screws and the conical surfaces. The lubricating grease must guarantee a coefficient of friction of 0.04.

Tolerances, roughness depth:

A machine turned finish is sufficient.

Maximum permissible tolerances:

f7 for the outer diameter of the hollow shaft (catalogue value d)

Maximum roughness depth: R_t max. 16 μm (R_a 3 μm – R_z 13 μm)

Tolerances for shaft diameter d_w :

H7/h6 for shaft diameters up to 150 mm

H7/g6 for shaft diameters from 155 mm

Series TLK 622 and TLK 623 clamping screws DIN 931 10.9

Series TLK 681 and TLK 683 clamping screws DIN 931 12.9

We will be happy to advise you with regard to individual dimensioning and any other questions you may have.

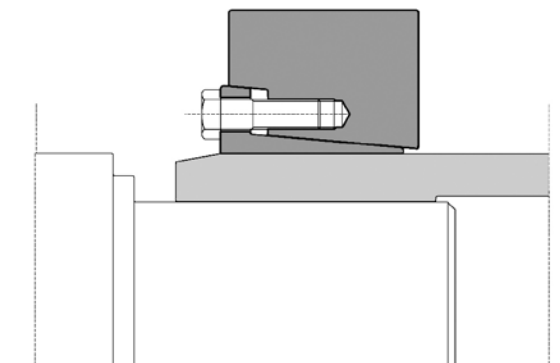

Shrink discs

TLK 622 self-centering – no axial movement during mounting
 TLK 681 self-centering – no axial movement during mounting



Type	Shaft diameter	TLK 622			TLK 681			Dimensions					Clamping screws DIN 931	Weight
		Torque	Axial force	Tightening torque	Torque	Axial force	Tightening torque	D	I	L	d1	e		
d [mm]	d _w [mm]	M _T [Nm]	F _A [kN]	M _S [Nm]	M _T [Nm]	F _A [kN]	M _S [Nm]	D [mm]	I [mm]	L [mm]	d1 [mm]	e [mm]	Type	[kg]
12	9	20	5	12				38	10	11	24	1	M6	0.1
	10	40	8											
14	11	30	6	12										
	12	50	9											
16	13	70	10	12										
	14	90	13											
18	15	80	11	12										
	16	110	14											
20	17	150	18	12										
	18	180	20											
24	19	160	17	12										
	20	210	20											
30	22	280	25	12										
	24	270	23											
36	25	320	25	30										
	26	360	28											
44	27	440	32	30										
	30	610	41											
50	33	820	50	30										
	34	690	41											
55	35	770	44	30										
	37	920	50											
62	38	1.110	58	30										
	40	1.290	65											
68	42	1.510	71	30										
	42	1.230	59											
75	45	1.530	68	30										
	48	1.860	78											
80	48	1.670	70	30										
	50	1.890	76											
88	52	2.120	81	30										
	50	1.870	75											
95	55	2.450	89	30										
	60	3.120	104											
100	55	2.330	85	59										
	60	3.020	101											
110	65	3.810	117	59										
	60	3.190	106											
120	65	4.060	123	59										
	70	4.910	140											
135	65	5.400	166	59										
	70	6.500	187											
150	75	7.800	208	59										
	70	6.000	171											
165	75	7.200	192	59										
	80	8.500	213											
180	80	10.000	249	100										
	85	11.700	275											
200	90	13.600	302	100										
	85	11.900	280											
225	90	13.800	307	100										
	95	15.900	334											
250	90	14.400	319	100										
	95	16.500	347											
280	100	18.700	375	100										
	95	18.100	382											
315	100	20.600	412	160										
	110	26.000	473											
350	100	19.600	392	160										
	105	22.100	421											
400	110	27.600	481	160										
	110	26.500	482											
450	115	29.500	514	160										
	125	36.100	578											
500	120	37.300	622	250										
	125	41.200	659											
560	135	49.600	734	250										
	130	45.000	692											
630	135	49.000	730	250										
	145	58.000	805											

Other sizes, inch dimensions and individual versions on request.

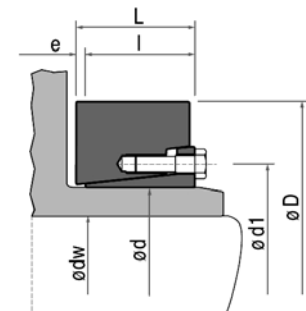



Shrink discs

TLK 622 self-centering – no axial movement during mounting

TLK 681 self-centering – no axial movement during mounting

Type	Shaft diameter	TLK 622			TLK 681			Dimensions					Clamping screws DIN 931	Weight
		Torque	Axial force	Tightening torque	Torque	Axial force	Tightening torque	D	l	L	d1	e		
d [mm]	d _w [mm]	M _T [Nm]	F _A [kN]	M _S [Nm]	M _T [Nm]	F _A [kN]	M _S [Nm]	D [mm]	l [mm]	L [mm]	d1 [mm]	e [mm]	Type	[kg]
185	140	64,000	916	250	81,000	1,157	300	320	75	85	222	10	M16	33
	145	70,000	961		88,000	1,210								
	155	82,000	1,053		102,000	1,319								
200	150	81,000	1,073	250	96,000	1,279	300	340	75	85	238	10	M16	36
	155	87,000	1,120		103,000	1,333								
	165	100,000	1,216		119,000	1,442								
220	160	103,000	1,283	490	129,000	1,615	570	370	91	103	268	12	M20	53
	170	119,000	1,395		149,000	1,749								
	180	136,000	1,509		169,000	1,883								
240	170	122,000	1,439	490	151,000	1,773	570	405	94	107	288	13	M20	66
	180	140,000	1,555		172,000	1,909								
	200	179,000	1,790		218,000	2,183								
260	190	163,000	1,715	490	212,000	2,231	570	430	105	119	312	14	M20	82
	200	184,000	1,842		238,000	2,385								
	220	231,000	2,099		297,000	2,696								
280	210	215,000	2,051	490	279,000	2,661	570	460	116	132	334	16	M20	103
	220	240,000	2,186		311,000	2,825								
	240	295,000	2,458		379,000	3,156								
300	220	270,000	2,456	840	332,000	3,018	980	485	124	140	360	16	M24	120
	230	300,000	2,605		367,000	3,193								
	250	363,000	2,906		443,000	3,545								
320	240	301,000	2,511	840	404,000	3,370	980	520	124	140	380	16	M24	138
	250	332,000	2,655		444,000	3,549								
	270	398,000	2,945		528,000	3,911								
340	250	390,000	3,118	840	488,000	3,905	980	570	137	155	402	18	M24	189
	260	427,000	3,283		533,000	4,101								
	280	506,000	3,617		630,000	4,498								
350	270	493,000	3,649	840	616,000	4,563	980	580	142	162	414	20	M24	202
	280	535,000	3,825		669,000	4,778								
	290	580,000	4,001		725,000	5,000								
360	270	496,000	3,676	840	625,000	4,628	980	590	142	162	424	20	M24	207
	280	539,000	3,852		677,000	4,839								
	300	631,000	4,206		790,000	5,264								
380	290	585,000	4,034	1,250	725,000	5,000	1,450	640	146	166	454	20	M27	244
	300	632,000	4,215		783,000	5,220								
	310	681,000	4,397		844,000	5,445								
390	290	640,000	4,411	1,250	781,000	5,384	1,450	650	146	166	454	20	M27	249
	300	691,000	4,605		842,000	5,611								
	320	799,000	4,996		971,000	6,069								
420	320	742,000	4,640	1,250	969,000	6,057	1,450	670	166	186	486	20	M27	285
	330	797,000	4,829		1,038,000	6,290								
	350	912,000	5,209		1,183,000	6,758								
440	340	945,000	5,557	1,250	1,212,000	7,128	1,450	720	174	194	506	20	M27	357
	350	1,009,000	5,764		1,292,000	7,382								
	370	1,143,000	6,181		1,460,000	7,891								
460	360	1,104,000	6,133	1,250	1,393,000	7,739	1,450	770	174	194	534	20	M27	419
	370	1,174,000	6,345		1,479,000	7,995								
	390	1,320,000	6,771		1,660,000	8,511								
480	380	1,300,000	6,843	1,640	1,657,000	8,721	1,970	800	191	213	552	22	M30	492
	390	1,378,000	7,066		1,754,000	8,993								
	410	1,541,000	7,516		1,956,000	9,542								
500	400	1,496,000	7,478	1,640	1,887,000	9,435	1,970	850	191	213	572	22	M30	567
	410	1,581,000	7,711		1,992,000	9,717								
	430	1,759,000	8,180		2,211,000	10,283								
530	430	1,930,000	8,976	1,640	2,397,000	11,150	1,970	910	216	238	606	22	M30	744
	440	2,031,000	9,234		2,521,000	11,459								
	460	2,243,000	9,752		2,778,000	12,078								
560	450	2,097,000	9,318	1,640	2,545,000	11,313	1,970	940	216	238	632	22	M30	776
	460	2,201,000	9,572		2,671,000	11,611								
	480	2,420,000	10,081		2,930,000	12,210								
590	470	2,593,000	11,032	1,640	2,969,000	12,636	1,970	960	235	260	664	25	M30	835
	480	2,715,000	11,314		3,108,000	12,952								
	500	2,970,000	11,881		3,397,000	13,587								
620	500	2,904,000	11,616	1,640	3,402,000	13,608	1,970	1,020	261	286	706	25	M30	1,064
	520	3,169,000	12,190		3,708,000	14,261								
	540	3,447,000	12,767		4,028,000	14,918								

Other sizes, inch dimensions and individual versions on request.

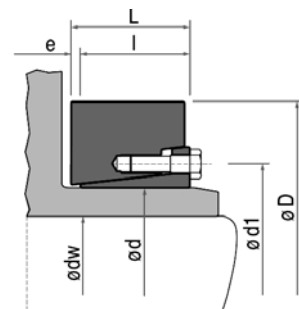

Shrink discs

TLK 623 self-centering – no axial movement during mounting
 TLK 683 self-centering – no axial movement during mounting



Type	Shaft diameter	TLK 623			TLK 683			Dimensions					Clamping screws DIN 931	Weight
		Torque	Axial force	Tightening torque	Torque	Axial force	Tightening torque							
d [mm]	d _w [mm]	M _T [Nm]	F _A [kN]	M _S [Nm]	M _T [Nm]	F _A [kN]	M _S [Nm]	D [mm]	I [mm]	L [mm]	d1 [mm]	e [mm]	Type	[kg]
140	100	26,000	523	250	30,000	607	300	230	64	74	174	10	M16	13
	105	30,000	562		34,000	650								
	115	37,000	641		42,000	737								
155	110	36,000	646	250	45,000	810	300	263	70	80	194	10	M16	19
	115	40,000	687		49,000	860								
	125	48,000	772		60,000	959								
165	120	50,000	828	250	63,000	1,047	300	290	77	88	204	11	M16	26
	125	55,000	877		69,000	1,105								
	135	66,000	977		83,000	1,223								
175	130	61,000	943	250	73,000	1,121	300	300	77	88	214	11	M16	27
	135	67,000	993		80,000	1,178								
	145	79,000	1,094		94,000	1,292								
185	140	89,000	1,269	490	106,000	1,512	570	320	100	112	232	12	M20	40
	145	96,000	1,330		115,000	1,582								
	155	113,000	1,455		134,000	1,723								
200	150	104,000	1,391	490	126,000	1,685	570	340	100	112	246	12	M20	44
	155	113,000	1,453		136,000	1,757								
	165	130,000	1,577		157,000	1,900								
220	160	127,000	1,591	490	162,000	2,027	570	370	121	134	266	13	M20	64
	165	137,000	1,661		174,000	2,112								
	180	169,000	1,876		213,000	2,366								
240	170	157,000	1,847	490	206,000	2,424	570	405	130	144	286	14	M20	81
	180	180,000	1,996		235,000	2,607								
	200	230,000	2,300		298,000	2,978								
260	190	230,000	2,424	490	285,000	3,000	570	430	144	160	306	16	M20	102
	200	260,000	2,600		321,000	3,207								
	220	325,000	2,957		399,000	3,623								
280	210	306,000	2,918	840	361,000	3,435	980	460	156	172	334	16	M24	126
	220	342,000	3,105		401,000	3,646								
	240	418,000	3,485		489,000	4,074								
300	230	360,000	3,132	840	461,000	4,010	980	485	158	176	354	18	M24	141
	240	398,000	3,314		508,000	4,230								
	250	437,000	3,498		556,000	4,452								
320	240	430,000	3,580	840	512,000	4,269	980	520	166	184	374	18	M24	171
	250	473,000	3,781		562,000	4,498								
	270	565,000	4,186		670,000	4,960								
340	250	551,000	4,407	1,250	661,000	5,288	1,450	570	186	206	404	20	M27	235
	260	603,000	4,637		722,000	5,552								
	280	714,000	5,100		852,000	6,086								
360	270	671,000	4,969	1,250	763,000	5,654	1,450	590	188	210	424	22	M27	251
	280	729,000	5,204		828,000	5,914								
	300	852,000	5,679		966,000	6,438								
390	290	850,000	5,860	1,250	978,000	6,743	1,450	650	196	220	456	24	M27	324
	300	917,000	6,116		1,054,000	7,029								
	320	1,061,000	6,633		1,217,000	7,606								
420	320	1,007,000	6,294	1,250	1,297,000	8,106	1,450	690	221	246	486	25	M27	409
	330	1,080,000	6,547		1,389,000	8,416								
	350	1,235,000	7,058		1,582,000	9,040								
440	340	1,218,000	7,166	1,640	1,583,000	9,312	1,970	750	233	258	514	25	M30	526
	350	1,301,000	7,433		1,687,000	9,642								
	370	1,475,000	7,972		1,907,000	10,306								
460	360	1,402,000	7,791	1,640	1,734,000	9,632	1,970	770	233	258	534	25	M30	544
	370	1,491,000	8,062		1,841,000	9,953								
	390	1,678,000	8,606		2,067,000	10,599								
480	380	1,707,000	8,984	1,640	2,076,000	10,926	1,970	800	270	298	552	28	M30	642
	390	1,809,000	9,277		2,198,000	11,270								
	410	2,023,000	9,867		2,452,000	11,961								
500	400	1,993,000	9,963	1,640	2,529,000	12,645	1,970	850	270	300	572	30	M30	741
	410	2,106,000	10,273		2,669,000	13,021								
	430	2,342,000	10,895		2,962,000	13,777								
530	430	2,549,000	11,857	2,210	3,093,000	14,385	2,650	890	306	338	616	32	M33	899
	440	2,683,000	12,196		3,252,000	14,782								
	460	2,962,000	12,878		3,584,000	15,581								
560	450	2,837,000	12,609	2,210	3,439,000	15,284	2,650	940	306	338	646	32	M33	1.000
	460	2,978,000	12,950		3,607,000	15,683								
	480	3,272,000	13,634		3,956,000	16,485								

Other sizes, inch dimensions and individual versions on request.

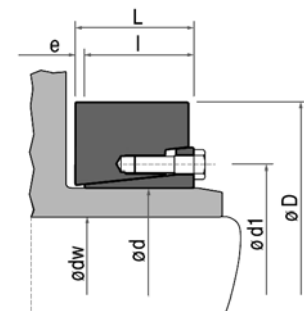

We will be happy to advise you with regard to your individual use case.

We work with you to find the best solution for your particular machine.

