

## 601F/601F-M INFRA-RED FLAME DETECTORS

### PRODUCT APPLICATION AND DESIGN INFORMATION

## 1. INTRODUCTION

The 601F Infra-red Flame detectors form part of the Series 600 range of plug in detectors for ceiling mounting. The detector plugs into a 5B 5" Universal Base or 5BD 5" Conventional Continuity Base and is intended for two-wire operation with the majority of control equipment currently manufactured by the company.

The 601F-M is the Marine version of the 601F.

The 601F is solar blind.

The detector is only suitable for indoor use.

## 2. OPERATING PRINCIPLE

### 2.1 OPTICAL CHARACTERISTICS

The 601F is designed to detect the infra-red radiation produced by flaming fires involving carbonaceous materials.

Fig. 1(a) shows the spectrum of a typical fire of this type

Fig. 1(b) the spectrum of the radiation of the sun and

Fig. 1(c), that of a tungsten filament lamp.

It can be seen that there is a large peak in the flame output at wavelengths in the region of  $4.45\mu\text{m}$ . This peak is a characteristic of carbonaceous flames and results from the formation of carbon dioxide in the flame. It will be seen also that the radiation from the sun and from the filament lamp is relatively low in this region.

In order to exploit these spectral characteristics, the 601F uses an optical filter which transmits infra-red between  $4.38\mu\text{m}$  and  $4.56\mu\text{m}$  (shown shaded in fig. 1(a)). This bandwidth allows high sensitivity to flames with low sensitivity to other interfering sources.

### 2.2 FLICKER CHARACTERISTICS

It is observed that the radiation from a flame is not constant but varies with time. This flicker is present in all flames to a greater or lesser degree (including those resulting from high pressure gas jets) and can be used to give improved discrimination between flames and other sources of infra-red.

The 601F responds to flicker frequencies in the range 1-10Hz which provides high sensitivity to almost all types of accidental fire.

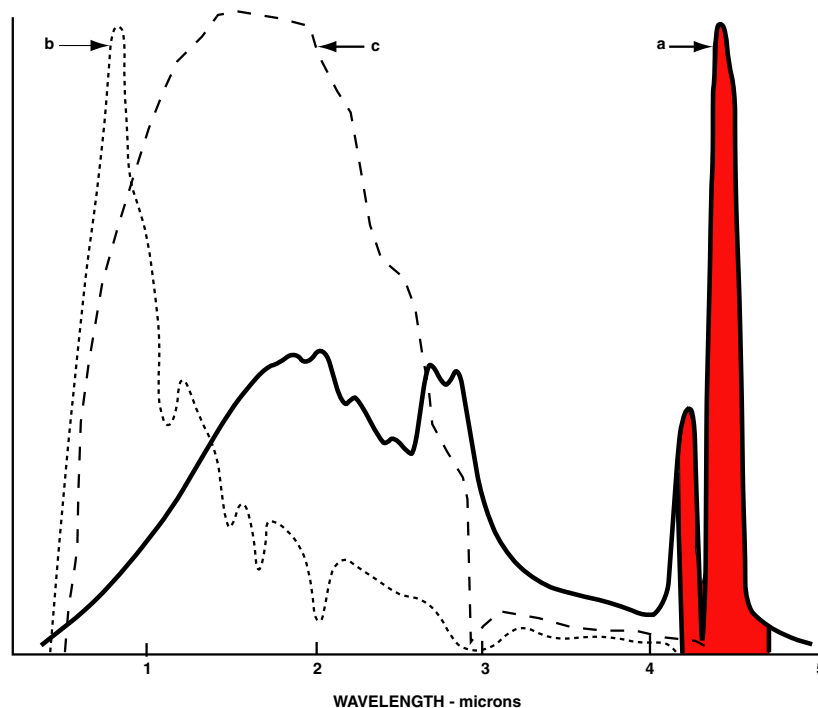
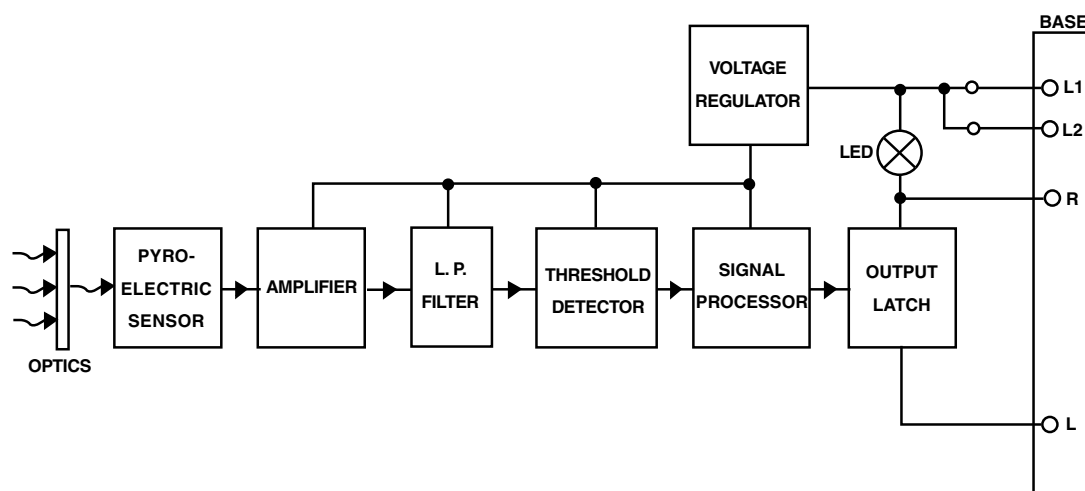

Fig. 1 Spectrums of: a) Typical Carbonaceous Fire b) Solar Radiation at Ground Level  
c) Tungsten Filament Lamp



**Fig. 2 Simplified Block Schematic Diagram of Detector**

## 2.3 CIRCUIT OPERATION

A simplified block schematic of the circuit is given in Fig. 2.

The infra-red radiation passing through the narrow-band filters falls on a pyroelectric sensor which responds to the flickering component of the radiation. The electrical signal produced is amplified and filtered, to remove frequencies outside the required flicker region.

The threshold detector and signal processor evaluate the amplitude and frequency characteristics of the flicker. If the flicker signal is above the preset threshold for three seconds, the output latch is triggered to light the internal LED alarm indicator. The increased current drawn from the line signals the alarm condition to the control unit.

All critical parts of the circuit are fed by an internal voltage regulator to make the sensitivity independent of supply over a wide range.

The facility for a remote LED indicator is available without the need for additional circuitry.

Two +ve terminals are provided to allow the monitoring of the circuit wiring through the detector.

## 2.4 WIRING

Loop cabling is connected to base terminals as follows:

L	-VE IN/OUT
L1	+VE IN
L2	+VE OUT
R	Remote LED Drive

## 3. MECHANICAL CONSTRUCTION

The major components of the detector are:

- Body Assembly
- Printed Circuit
- Outer Cover
- Sapphire lens

### 3.1 BODY ASSEMBLY

The body assembly consists of a plastic moulding to which are secured the four detector contacts which align with contacts in the base. The moulding incorporates securing features to retain the detector in the base.

The PCB is fitted into the base tray and then the outer cover with sapphire window is clipped onto the onto the base, securing features securing the PCB.

## 4. APPROVALS

The 601F/601F-M meet all the requirements of EN 54 : Part 10 as a Class 2 flame detector.

## 5. TECHNICAL SPECIFICATION

### 5.1 MECHANICAL

#### Dimensions

The overall dimensions are shown in Fig. 3.

#### Materials

Body, cover, and closure: FR110 'BAYBLEND' flame retardant.

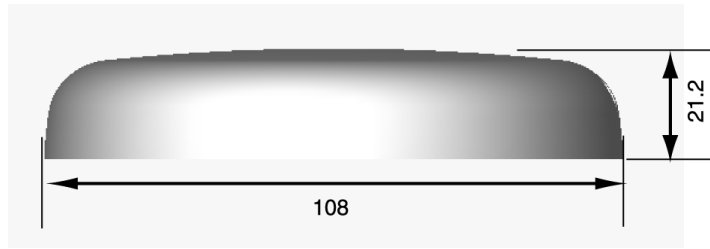

**Fig. 3 Overall Dimensions of 601F Detector**

**Weight**

Detector: 74g

*Note: The EMC standards fulfil the requirements of the European Directive for EMC (89/336/EEC).*

**5.2 ENVIRONMENTAL**

Operating Temperature: -20°C to +70°C  
- but see note below.  
Storage Temperature: -40°C to +80°C

**5.4 ELECTRICAL CHARACTERISTICS**

Table 1 shows the electrical characteristics, these are taken at 25°C with an operating voltage of 20V unless otherwise specified. The alarm load presented to the controller by the detector is shown in Fig. 4.

*Note:*

1) Operation below 0°C is not recommended unless steps are taken to eliminate condensation and hence ice formation on the detector.

**Relative Humidity**

Operational: 90% RH continuous (non-condensing) and up to 99% RH intermittent (non-condensing)  
Storage: >40% RH and <70% RH

Shock:  
Vibration:  
Impact:  
Corrosion: } To EN54 Part 10

Characteristics	Min.	Typ.	Max.	Unit
Operating Voltage (dc)	18		28	V
Quiescent Current	150	300	350	µA
Switch-on-Surge		850	1000	µA
Stabilisation Time			30	sec
Alarm Current	36mA @ 18V 42mA @ 20V 70.5mA @ 31V			mA
Holding Current			1	mA
Holding Voltage			5	V
Reset Time	1/2	1	2	sec
Remote LED drive	via a 3.4k resistor			

**Table. 1 Electrical Characteristics**

**5.3 ELECTROMAGNETIC COMPATIBILITY**

The detector complies with the following:

Product family standard EN50130-4 in respect of Conducted Disturbances, Radiated Immunity, Electrostatic Discharge, Fast Transients and Slow High Energy  
EN61000-6-3 for Emissions

# SERIES 600

01C-02-D9

4 5/10

## 6. PERFORMANCE CHARACTERISTICS

### 6.1 MODE OF OPERATION-BEHAVIOUR IN FIRE TESTS

The operating principles of the detector have been described in Section 3 and the information given below is intended to supplement this basic description.

It has already been noted that the detector analyses the signal flicker frequency and produces an alarm if the level is above a preset threshold for three seconds. It is worth stressing that if the signal is below this threshold the detector will not respond even after a long time.

The level of the signal received depends on the size of the flame and its distance from the detector. For liquid fuels the level is almost proportional to the surface area of the burning liquid. For any type of fire, the signal level varies inversely with the square of the distance.

Fire tests are normally carried out using liquid fuels, burning in pans of known area. The sensitivity of a detector is then expressed as the distance at which a particular fire size can be detected.

It is important to think in terms of distance rather than time because of the burning characteristics of different fuels. Fig. 4 shows the typical response of two different fuels which ultimately produce the same signal level. The signal level given by n-heptane quickly reaches its maximum approximately six (6) seconds after ignition. Diesel, being less volatile, takes approximately sixty (60) seconds to reach equilibrium burning state and an alarm is given approximately fifty-five (55) seconds after ignition.

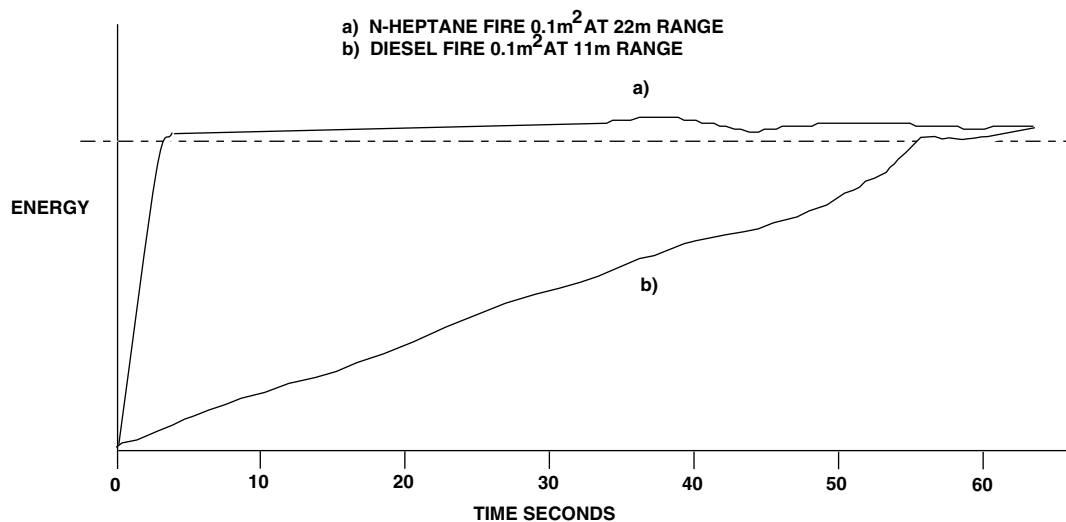
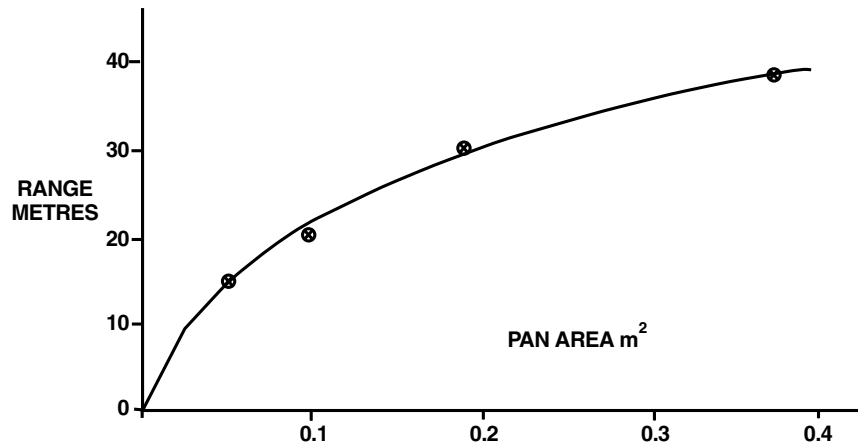

Fig. 4 Typical Response to Fires



**Fig. 5 Typical Detector Range vs Pan Area - n-heptane**

The time taken by the fire to reach equilibrium depends on the initial temperature of the fuel. If diesel is pre-heated to a temperature above its flash point, then it behaves the same as n-heptane at 25°C.

The fire test data presented in Section 5.2 refers to fires which have reached their equilibrium condition. The range specified is that obtained with the detector axis horizontal and with the fire on the detector axis.

**6.2 FIRE TEST DATA**

**6.2.1 N-HEPTANE**

The most convenient fuel for fire tests is n-heptane since it is readily available and quickly reaches its equilibrium burning rate. The range figures specified in Section 5.2.2 relate to a n-heptane fire in a 0.1m<sup>2</sup> pan on the main axis of the detector field of view.

The graph in Fig. 5 shows the typical detection ranges as a function of pan area for n-heptane fires. It will be seen that this curve is approximately a square law; that is to say that to obtain detection at twice the distance the pan area must be multiplied by four.

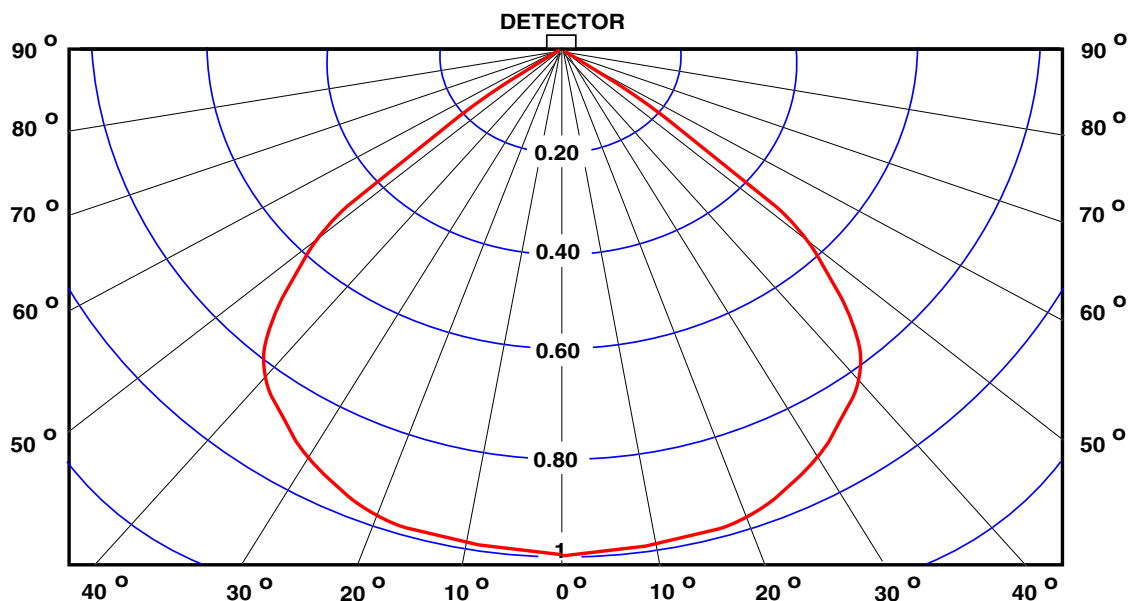

**Fig. 6 Relative Range vs Angle of Incidence**

# SERIES 600

01C-02-D9

4 5/10

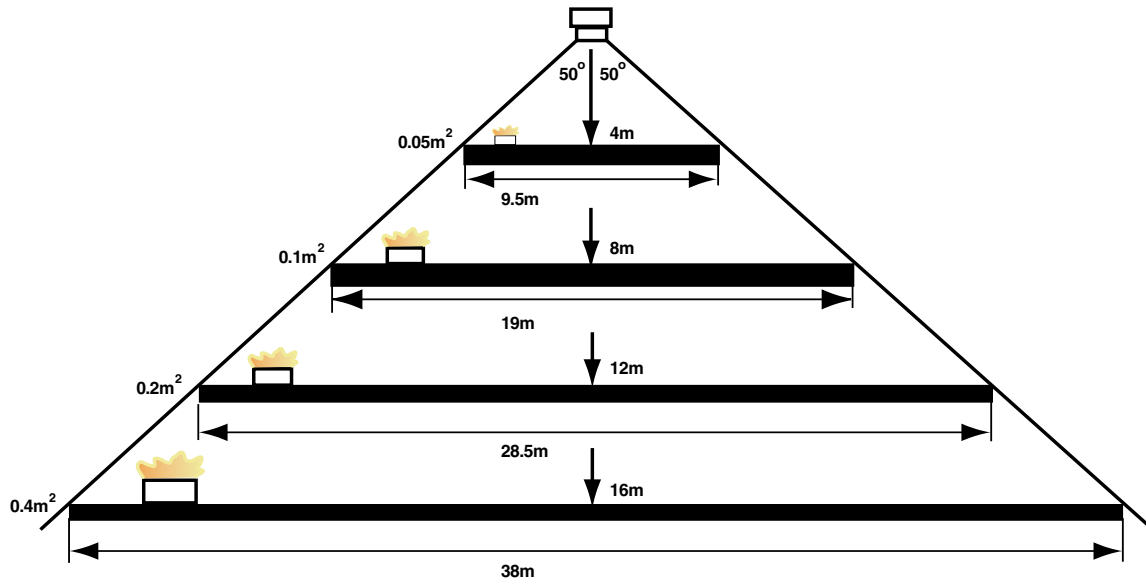

Fig. 7 Field of View

## 6.2.2 OTHER LIQUID HYDROCARBONS

Ranges achieved with other fuels burning in 0.1m<sup>2</sup> pans are as follows:

Kerosene	15.5m
Alcohol (I.M.S.)	13m
Diesel oil	13m
Ethylene glycol	15.5m

The typical detection range for other pan areas may be calculated using the square law relationship give in Para 6.2.1.

## 6.2.3 DIRECTIONAL SENSITIVITY

The sensitivity of the 601F is at a maximum on the detector axis. The variation of range with angle of incidence is shown in Fig. 7.

## 7. DESIGN OF SYSTEM

### 7.1 GENERAL

Using the information given in Sections 2 to 5, it is possible to design a flame detection system having a predictable performance. Guidance on the application of the above data and on siting of detectors is given on the following page.

## 7.2 USE OF FIRE TEST DATA

It has been explained in Section 5 that the sensitivity of the detector is specified in terms of its response to well-defined test fires. Tests are carried out using a 0.1m<sup>2</sup> pan. Sensitivity to other pan areas is calculated from the square law relationship. That is to obtain detection at twice the distance, the pan area must be multiplied by four.

Accidental fires are rarely of a well-defined size. It is still possible, however, to calculate the response to a 'real' fire using the fire test data.

For example, a spillage fire involving a highly volatile liquid, eg, n-heptane: will spread quickly from the point of ignition to cover the complete surface of the pool. Such a spillage would normally cover approximately 2m<sup>2</sup>. Using the data for n-heptane fires and extrapolating to an area of 2m<sup>2</sup>, the 601F should respond at a distance of about 120m.

If the spillage is of a less volatile material (eg, diesel), the spread of the flame from the ignition point will be much slower, as will the detector response time.

### 7.3 DETERMINING THE NUMBER OF DETECTORS

The number of detectors required for a particular risk will depend on the area involved and the fire size at which detection is required. Large areas or small fires require large numbers of detectors.

As there are no agreed 'rules' for the application of flame detectors, the overall system sensitivity must be agreed between the designer and the end user. When agreement has been reached the system designer can determine the area to be covered by each detector using the fire test data.

The detector is designed primarily for ceiling mounting with its axis vertically downwards. When used in this way it will cover a circular area at ground level, the diameters of the circle being proportional to the height. Under these conditions the effective sensitivity is that which is achieved at the edge of this circular area taking into account the slant range and the angle of incidence.

Fig. 6 shows the effective sensitivity for n-heptane fires when used in this configuration. Sensitivity to other fuels can be determined from the data given in Section 5.2.2.

*Note: Any object within the detector's field of view will cause a 'shadow' in the protected area. Small objects close to the detector can cause large shadows.*

### 8. CPD INFORMATION

 0832	
Tyco Safety Products Dunhams Lane Letchworth SG6 1BE UK  07  0832-CPD-0500	
EN 54-10:2002 + A1:2005  Conventional Class 2 point type flame detector for use in fire detection and alarm systems in buildings  601F 601F-M (Marine)	
Application & Design	01C-02-D9
Installation Instructions	01C-02-I1
Service Instructions	01C-02-S1

### 9. ORDERING INFORMATION

601F Infra-red Flame Detector:	516.600.006
601F-M Infra-red Flame Detector (Marine):	516.600.007
5B 5" Universal Base:	517.050.017
5BD 5" Conventional Diode Base:	517.050.600

JM/jm  
 5<sup>th</sup> May 2010