



Product Specification

XL125 Series

125-Watt AC to DC

Power Supplies

700723 Rev 09-10-17

Notices

N2Power is a wholly owned subsidiary of Qualstar Corporation.

N2Power and the *N2Power* logo are registered trademarks of Qualstar Corporation.

Copyright® 2004-2017 by Qualstar Corporation — All Rights Reserved

For warranty information refer to www.n2power.com

Information contained in this document is copyrighted by Qualstar Corporation and is intended for use by customers and prospective customers to evaluate and integrate our power supplies. Customers and prospective customers may reproduce this document as needed for these purposes. Reproduction in whole or in part for any other purpose or by any other party is prohibited without prior written permission from Qualstar Corporation.

Every effort has been made to keep the information contained in this document current and accurate as of the date of publication or revision. However, no guarantee is given or implied that the document is error-free or that it is accurate with regard to any specification. *N2Power* reserves the right to modify the design or specification without notice.

This specification may not be construed as a contractual obligation except as specifically agreed to by *N2Power* in writing at the time of order.

N2Power products are covered by U.S. Patent 6,163,139.

For information about this product specification, please write or call *N2Power* at:

N2Power

Subsidiary of Qualstar
130 West Cochran St., Suite C
Simi Valley, CA 93065

FAX: (805) 583-7749
Phone: (805) 583-7744

E-Mail: sales@n2power.com
www.n2power.com

Table of Contents

1.	Introduction	1-1
1.1	Introduction.....	1-1
1.2	Agency Compliance.....	1-2
2.	AC Input	2-1
2.1	Input Line Requirements.....	2-1
2.2	Input Over Current Protection.....	2-1
2.3	Inrush Current Limiting.....	2-1
2.4	Low Input Voltage.....	2-1
2.5	Leakage Current.....	2-1
3.	DC Outputs	3-1
3.1	Output Voltage Regulation.....	3-1
3.2	No Load Operation.....	3-2
3.3	Output Current/Power.....	3-2
3.4	Output Ripple/Noise.....	3-4
3.5	Local and Remote Sensing.....	3-6
3.6	Parallel Operation: Single Output CS Models Only.....	3-7
3.7	Output Protection.....	3-8
3.8	Output Rise Time.....	3-9
3.9	Overshoot At Turn On/Turn Off.....	3-10
3.10	Output Transients.....	3-10
3.11	Closed Loop Stability.....	3-10
3.12	Capacitive Load.....	3-10
4.	General Specifications	4-1
4.1	Environmental.....	4-1
4.2	Mean Time Between Failures.....	4-1
4.3	Component Stress.....	4-1
4.4	Labeling/Marking.....	4-2
4.5	Net Weight.....	4-2
4.6	Mounting.....	4-2
4.7	Physical Dimensions.....	4-3
4.8	Mating Connectors.....	4-3
4.9	Output Grounding.....	4-6
4.10	Signal Pin Definitions.....	4-7
5.	Efficiency	5-1
6.	Timing and Control	6-1
6.1	Power Supply Timing.....	6-1
6.2	Power Good Signal/PS_OK Signal/Remote ON Input.....	6-1

6.3	Power Good LED	6-2
6.4	Power Sequencing: XL125-1 and XL125-7	6-2
6.5	Voltage Hold-Up Time	6-3
7.	Ordering Information.....	7-1

1.

Introduction

1.1 Introduction

This specification defines the XL125 series of open frame, single-phase (3 wire) universal input, power factor corrected, 125-watt switch mode power supplies. It includes information regarding the mechanical details, cooling requirements, connector configurations, electrical and signal specifications, and environmental ranges for storage and operation of the power supply. These supplies achieve very high packaging densities and low cooling air requirements by virtue of their very high efficiency patented design. Except for one model, they are all 3.0x5.0x1.25-inches small. All of the XL125 family models are listed in Table 3-1.

The XL125-1 and XL125-1ATX are quad-output supplies. The XL125-1ATX adds a 5V, 1A standby supply that remains on, even when the four main outputs are shut-off remotely. This model meets the output requirements of Intel ATX/ATX12V Power Supply Design Guide (Version 2.03). Remote control is only available on the XL125-1ATX.

All models of the XL125 Series can be used as standalone power supplies. Single-output models XL125-03 through XL125-56 are available with internal OR-ing diodes so that up to 4 power supplies may be connected in parallel for redundant or N+1 configurations via a single wire current share line.

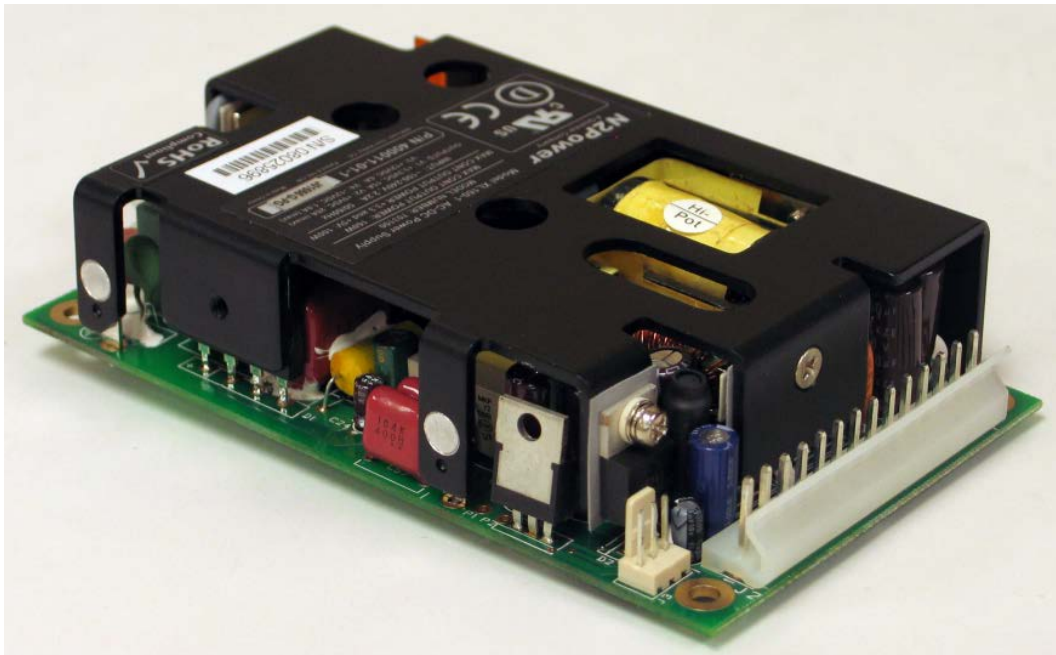



Figure 1-1 XL125 (models differ slightly)

1.2 Agency Compliance

Safety	Complies with Standard	Remarks
United States	UL 60950-1 (December 19, 2011) Second Edition (Information Technology Equipment)	Leakage Current – see table 2-2 Hi-pot – 2121vdc for 1 second
Canada	CAN/CSA-C22.2 No. 60950-1 (2007) Second Edition	
EU Council	2006/95/EC (August 2007)	Low Voltage Directive
International	IEC 60950-1 (2005) Second Edition	
China (CCC)	GB4943.1-2011	
Taiwan (BSMI)	CNS14336-1 (2010)	Selected models only
EMC	Complies with Standard	Remarks
United States	FCC part 15, subpart B	Conducted emissions Limits per CISPR 22 Class B Tested to ANSI C63.4: 2003
EU Council	2004/108/EC	EMC Directive
International	EN 61204-3 (refers to the following) EN 55022 Class B EN 55024 (refers to the following) EN 61000-3-2 Class D EN 61000-3-3 EN 61000-4-3 EN 61000-4-4 EN 61000-4-5 EN 61000-4-6 EN 61000-4-11	Low Voltage Power Supplies – DC Output Conducted emissions Limits per CISPR 22 Class B Immunity Harmonic Current Emissions (Power Factor Correction – PFC) Voltage Fluctuations & Flicker Radiated Susceptibility Fast Transient/Burst Immunity Power Mains Surge Immunity RF Immunity Voltage Dips, Short Interruptions
Reduction of Hazardous Substances (RoHS)	Complies with Standard	Remarks
EU Council	2002/95/EC 2011/65/EU	RoHS Directive RoHS 2 Directive

Continued below.

Marks of Conformance

United States & Canada  (Underwriters Laboratories File E211115)

China 

 *Only associated with the CCC mark.
Only used at altitude not exceeding 2000M.

 *Only associated with the CCC mark.
Only used in non-tropical climate regions.

Taiwan  *selected models only.

EU Council 

RoHS  

Table 1-1 Agency Compliance

2.1 Input Line Requirements

The following table defines the voltage and frequency requirements for the AC line inputs to the XL125, which is capable of supplying full rated power in continuous operation throughout the specified ranges of voltages and frequencies. The power supply will automatically recover from AC power loss and is capable of starting under maximum load at the minimum AC input voltage described below.

Parameter	Minimum	Nominal	Maximum
RMS Input Voltage	90 VAC	100–240 VAC	264 VAC
RMS Input Current	–	–	1.8 A @ 100 V 0.8 A @ 240 V
Input Frequency	47 Hz	50/60 Hz	63 Hz

Table 2-1 XL125 AC Input Parameters

2.2 Input Over Current Protection

The XL125 series incorporates a primary AC line fuse for input over current protection to prevent damage to the power supply and meet product safety requirements as outlined in Section 1.2.

2.3 Inrush Current Limiting

The cold start inrush current is limited to 33 A peak at 115 VAC. Repetitive ON/OFF cycling of the AC input voltage shall not damage the power supply or cause the input fuse to fail.

2.4 Low Input Voltage

The application of an input voltage below the minimums specified in Table 2-1 shall not cause damage to the power supply.

2.5 Leakage Current

The leakage current from AC line or AC Neutral inputs to Earth Ground at 240 VAC, 50 Hz is less than 750 microamps.

3.

DC Outputs

3.1 Output Voltage Regulation

The DC output voltages shall remain within the Minimum and Maximum limits of Table 3-1 when measured at the power supply connector under all specified line, load and environmental conditions contained herein. The main output (V1) in the single output models (-12 thru -56V) and the 12-volt auxiliary outputs are both galvanic isolated from each other and chassis (Safety ground). Refer to section 3.3.2. Thus that output can be used as either a positive or negative supply.

Model	Output	Rated Voltage	Regulation	Minimum (VDC)	Nominal (VDC)	Maximum (VDC)	RemoteSense
XL125-1	V1	+3.3	±2%	3.234	3.300	3.366	V1/RTN
	V2	+5	±4%	4.848	5.050	5.252	
	V3	+12	±5%	11.400	12.000	12.600	
	V4	-12	±5%	-11.400	-12.000	-12.600	
ATX only	V5	+5V _{standby}	±5%	4.750	5.000	5.250	
XL125-7	V1	+2.5	±2%	2.450	2.500	2.550	V1/RTN
	V2	+5	±4%	4.848	5.050	5.252	
	V3	+12	±5%	11.400	12.000	12.600	
	V4	-12	±5%	-11.400	-12.000	-12.600	
XL125-8	V1	none					RTN only
	V2	+5	±4%	4.848	5.050	5.252	
	V3	+12	±5%	11.400	12.000	12.600	
	V4	-12	±5%	-11.400	-12.000	-12.600	
XL125-03 [CS]	V1	+3.3	±3%	3.200	3.300	3.400	V1/RTN
XL125-05 [CS]	V1	+5	±3%	4.848	5.050	5.252	V1/RTN
XL125-12 [CS]	V1*	+12	±3%	11.640	12.000	12.360	V1/RTN
XL125-15 [CS]	V1*	+15	±3%	14.550	15.000	15.450	V1/RTN
XL125-24 [CS]	V1*	+24	±3%	23.280	24.000	24.720	V1/RTN
XL125-28 [CS]	V1*	+36	±3%	27.160	28.000	28.840	V1/RTN
XL125-48 [CS]	V1*	+48	±3%	46.560	48.000	49.440	V1/RTN
XL125-54 [CS]	V1*	+54	±3%	52.380	54.000	55.620	V1/RTN
XL125-56 [CS]	V1*	+56	±3%	54.320	56.000	57.680	V1/RTN
ALL -XX [CS]	V2*	+/-12V _{aux}	±5%	11.400	12.000	12.600	

* These outputs are isolated on single output models (+ or – terminal may be grounded)
[CS] indicates the Current Share option. These items are for either with or without current sharing

Table 3-1 XL125 Output Voltage Specifications

3.2 No Load Operation

The power supply will operate with reduced output voltage regulation of +/-10% with all outputs unloaded. This no load condition will not damage the XL125 or cause a hazardous condition, however the Power Good signal may not go true with less than a 5-watt load. The power supply will remain stable and operate normally after application of loads.

CAUTION

Remove AC power prior to installing or removing secondary loads.

3.3 Output Current/Power

The maximum available output power is always a function of the cooling airflow and temperature. The total output is reduced with unrestricted natural convection cooling and an ambient temperature of 50°C or less. No output will exceed 190VA under any of overload or short circuit condition including single component fault conditions as described by IEC 60950.

3.3.1 Output Loading for Multiple Output Models

The maximum combined output power of V1 through V4 is limited to 125 watts with 5 CFM of forced air-cooling at no more than 50°C. On the XL125-1ATX the V5 output is limited to 5 watts under the same conditions (total of 130 watts possible).

Output	Rated V1 Output	Minimum Load	Maximum Load	Maximum Watts/Output
V1 (-1)	+3.3 V	0.0 A	10.0 A	33
V1 (-7)	+2.5V	0.0 A	12.0 A	30
V1 (-8)	None	—	—	—
V2 (-1,-7)	+5 V	1.0 A	15.0 A	75
V2 (-8)	+5 V	1.0 A	16.5A	82.5
V3 (All)	+12 V	0.0 A	6.0 A	60
V4 (All)	-12 V	0.0 A	1.0 A	6
V5 (ATX Only)	+5V _{standby}	0.0 A	1.0 A	5

Table 3-2 XL125-1, -7, -8 Individual Min/Max Load Currents at 5CFM and 50°C

With unrestricted natural convection cooling, the maximum combined output power of V1 through V4 is limited to 70 watts while the +5V_{standby} output on the XL125-1ATX is limited to 0.5A (total of 72.5 watts possible). Additionally, the sum of the V1 and V2 outputs is limited to 40 watts.

3.3.2 Output Loading for Single Output Models

The output currents listed in Table 3-3 require at least 5 CFM of forced air-cooling at no more than 50°C. The XL125-03 requires 10CFM of cooling air for 105-watts output.

The total output of 125-watts must be reduced to 100-watts with unrestricted natural convection cooling at an ambient temperature of 50°C or less except: the XL125-05 is limited to 70-watts and the XL125-03 is limited to 62-watts.

These single-output models all have an 12-volt auxiliary output (V2) that is typically used to drive a cooling fan. The load on this V2 output can vary from 0 to 1 amps and does not affect the Power Good or PS_OK signals. Its load power detracts from the 125-watts otherwise available to the V1 load. The main output (V1) in the single output models (-12 thru -56V) and the 12-volt auxiliary outputs are both galvanic isolated from each other and chassis (Safety ground). Thus, they can be used as either a positive or negative supply.

The signals on J3: DC Return, Current Share, PG and PS_OK are all reference to the negative rail of the V1 Main output. Connecting the “+” voltage lead to ground or customer’s return will yield a negative voltage on the “-“ leads.

Model	Rated V1 Output	Power Good Load ①	Maximum Forced Air Load ②	Maximum Convection Load ②
XL125-03 [CS]	3.3 V	1.5 A	32.0 A	18.8 A
XL125-05 [CS]	5 V	1.0 A	25.0 A	14.0 A
XL125-12 [CS]	12 V	0.4 A	10.42 A	8.4 A
XL125-15 [CS]	15 V	0.33 A	8.3 A	6.6 A
XL125-24 [CS]	24 V	0.2 A	5.2 A	4.2 A
XL125-28 [CS]	28 V	0.18 A	4.5 A	3.6 A
XL125-48 [CS]	48 V	0.09 A	2.6 A	2.1 A
XL125-54 [CS]	54 V	0.09 A	2.3 A	1.9 A
XL125-56 [CS]	56 V	0.09 A	2.2 A	1.8 A
XL125-03 [CS]	+/-12V _{Aux}	N/A	0.5A	0.25A
XL125-05 [CS]	+/-12V _{Aux}	N/A	0.5A	0.25A
XL125-12 thru -56 [CS]	+/-12V _{Aux}	N/A	1.0 A	0.5 A

① Minimum load needed for the Power Good signal to go high and the PS_OK signals to go low.

② Assuming no load on the 12V_{Aux} output.

Table 3-3 Min/Max Load Currents Single Output Models

3.3.3 High Temperature Derating

The XL125 can be operated at elevated temperatures by derating the total maximum output power (or current) by 2.5%/°C from 50°C to 70°C (see Figure 3-1).

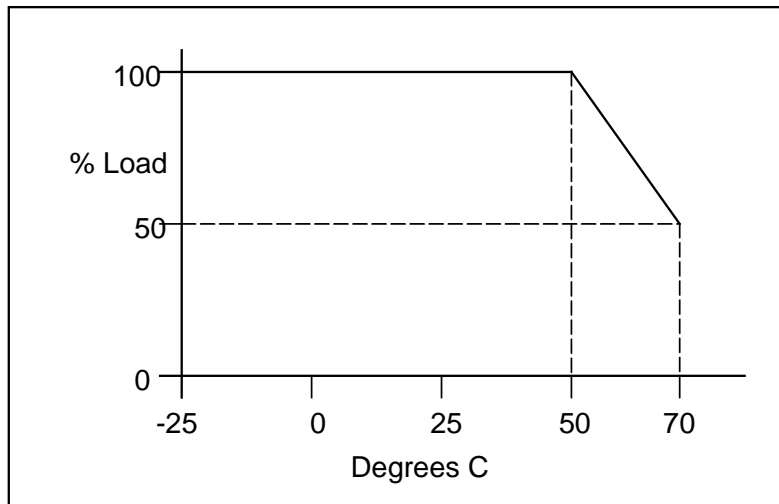

Figure 3-1 XL125 Output Power vs. Ambient Temperature Envelope

3.4 Output Ripple/Noise

Output ripple voltage and noise are defined as periodic or random signals over a frequency band of 10 Hz to 20 MHz. Measurements are to be made with an oscilloscope with at least 20 MHz bandwidth. Outputs should be bypassed at the connector with a 0.1 μ F ceramic disk capacitor and a 10 μ F tantalum capacitor to simulate system loading (see Figure 3-2). Ripple and noise shall not exceed the limits specified in the following tables.

3.4.1 Ripple/Noise Limits: Multiple Output Models (-1, -1ATX, -7, -8)

The ripple voltage of the outputs is measured at the pins of the mating connector. Ripple and noise shall not exceed the limits specified in Table 3-4 under any condition of line voltage and frequency specified in Section 2.1 and DC loading specified in Section 3.3.1.

Output	Voltage	Maximum Ripple+Noise (peak-to-peak)
V1	+3.3/+2.5 V	50 mV
V2	+5 V	50 mV
V3	+12 V	120 mV
V4	-12 V	120 mV
V5	+5 V SB	50 mV

Table 3-4 Ripple + Noise Output: Multiple Output Models (-1, -1ATX, -7, -8)

3.4.2 Ripple/Noise Limits: Single Output Models (-03 through -56)

The ripple voltage of the outputs is measured at the pins of the mating connector. Ripple and noise shall not exceed the limits specified in Table 3-5 under any condition of line voltage and frequency specified in Section 2.1 and DC loading specified in Section 3.3.2.

Model	Output	Voltage	Maximum Ripple+Noise (peak-to-peak)
XL125-03 [CS]	V1	3.3V	50 mV
XL125-05 [CS]	V1	+5 V	50 mV
XL125-12 [CS]	V1	+12 V	120 mV
XL125-15 [CS]	V1	+15 V	150 mV
XL125-24 [CS]	V1	+24 V	240 mV
XL125-28 [CS]	V1	+28 V	280 mV
XL125-48 [CS]	V1	+48 V	480 mV
XL125-54 [CS]	V1	+54 V	540 mV
XL125-56 [CS]	V1	+56 V	560 mV
All Models	V2	+/-12V _{Aux}	120 mV

Table 3-5 Ripple Voltage: Single Output Models (-03 through -56)

3.4.3 Ripple/Noise Test Setup

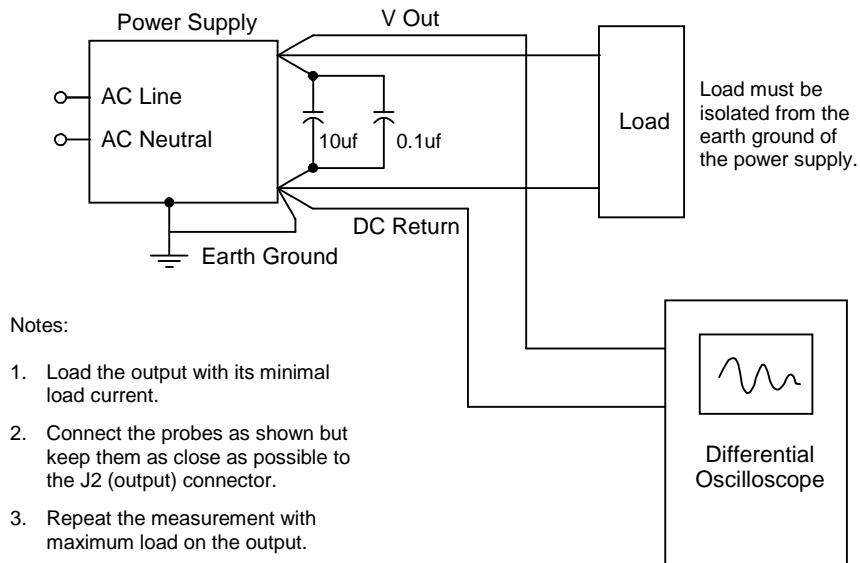

Figure 3-2 Ripple Noise Measurement Setup

3.5 Local and Remote Sensing

Remote sensing is provided to compensate for voltage drops in the V1 (+ Output) and DC RETURN connections to the load. For every model, the 0V Sense input must always be connected to either one of the DC Return pins of the XL125 or the DC Return terminal at the load. Connecting it to the return side of the load will reduce the voltage drop in the external return wiring.

If the V1 Sense input is left open, the V1 output may not meet its load regulation specification. The V1 output will meet its load regulation specification when the V1 Sense pin is connected to one of the V1 output pins. Connecting the V1 Sense pin to the V1 output at the load will reduce the voltage drop in the external V1 wiring.

3.5.1 Local and Remote Sensing: Multiple Output Models (-1, -1ATX, -7, -8)

The V1 Sense input need not be connected for the XL125-8, as it has no V1 output. The XL125-1 and XL125-7 can compensate for up to 0.2V drop in each side (+Output and RETURN). Figure 3-3 shows the required local and optional remote sensing connections. Note that on an XL125-1ATX J3 has 5-pins instead of the 3-pins shown below but pins 1 and 2 are still used for remote sense as shown in Figure 3-5. Refer to Table 4-7 for the pin definition of the XL125 connectors.

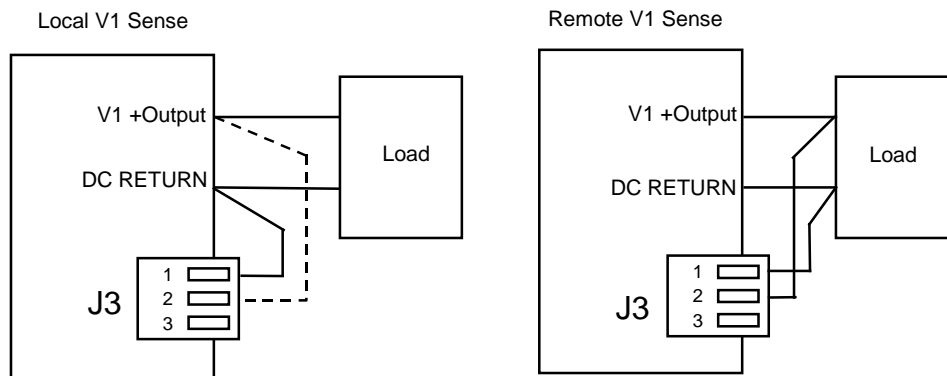

Figure 3-3 Local and Remote Sensing Wiring: Multiple Output Models (-1, -1ATX, -7, -8) (see text)

3.5.2 Local and Remote Sensing: Single Output Models (-03 and -05)

Up to 0.2V in the return and the V1 connections may be compensated. Note that J3 has 5-pins but only the first three are shown in Figure 3-4 which shows the required and optional remote sensing connections. Refer to Table 4-7 for the pin definition of the XL125 connectors.

These single output models are available with internal OR-ing MOSFETs so that multiple power supplies may be connected in parallel. Follow the same sense wiring for each paralleled supply as if it were a single supply.

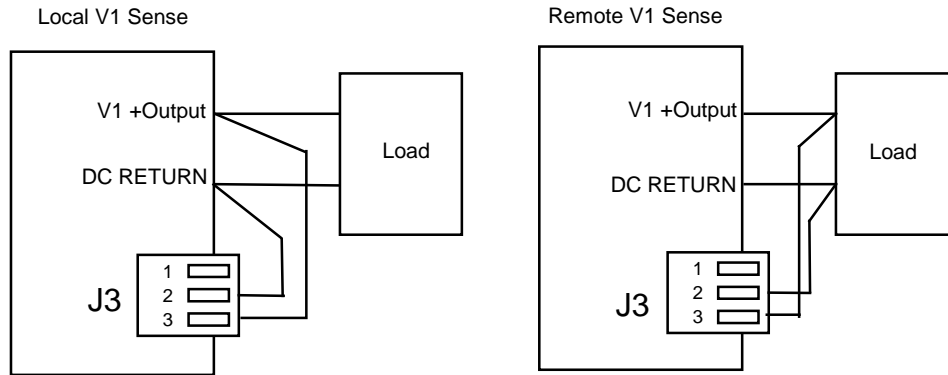

Figure 3-4 Local and Remote Sensing Wiring: Single Output Models (-03 and -05)

3.5.3 Local and Remote Sensing: Single Output Models (-12 through -56)

Up to 0.5V in the return and 0.5V in the V1 connection may be compensated. Figure 3-5 shows the required and optional remote sensing connections. J3 actually has six-pins but only the first three are shown below. Refer to Table 4-7 for the pin definition of the XL125 connectors.

These single output models are available with internal OR-ing diodes so that multiple power supplies may be connected in parallel. Follow the same sense wiring for each paralleled supply as if it were a single supply.

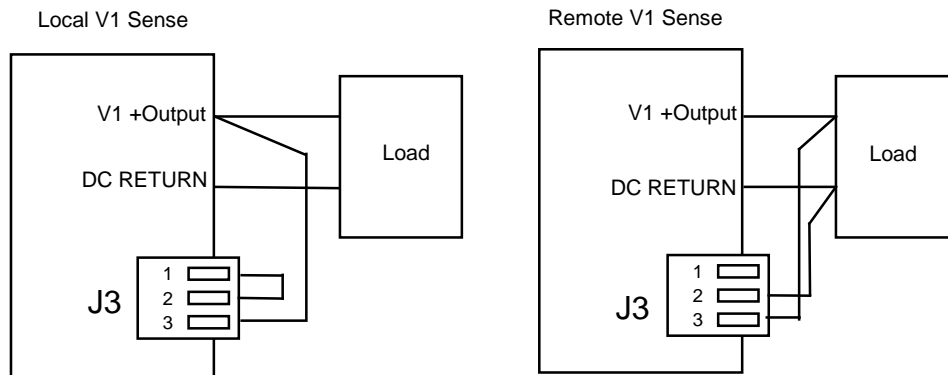

Figure 3-5 Local and Remote Sensing Wiring: Single Output Models (-12 through -56)

3.6 Parallel Operation: Single Output CS Models Only

Single output models are available in stand-alone or current-share versions. The current share (CS) versions add a built-in output OR-ing diode (in the case of -03 and -05) and MOSFETs (in the case of -12 thru -56 models) plus active single-wire current share circuitry for parallel operation.

Two, three or four XL125 CS version power supplies may be connected in parallel to provide higher output power and greater reliability for redundant or N+1 configurations.

3.6.1 Current Share Connections

The Current Share signal (see Table 4-7) of each supply operating in parallel must be connected together. Power sharing does not require the 0V Sense signals be connected together, but the sharing accuracy may not meet published specification unless they are also connected together.

Power Good signals may be wire ORed together, but this is not recommended, as a failing power supply will pull the common signal low. They should be monitored individually by the user's system.

3.6.2 Current Share Accuracy

When all the current share signals are connected together and all the 0V Sense signals are connected together, the load delivered by any two supplies of the sharing supplies will not vary by more than 10% at full load.

3.6.3 Transients

The output rise time and monotonic requirements of Section 6.3 may not be met where the load exceeds 125-watts, because of the difference in start-up times of the paralleled power supplies.

When the AC line to one of the parallel power supplies is disconnected or reconnected, or a power supply fails, the transient on the V1 output is within five (5) percent of nominal output voltage, although the output voltage may ramp to a new nominal voltage within the regulation band.

3.7 Output Protection

There are three different output protection schemes designed to protect the load and the XL125 from component failures and extraordinary circumstances.

3.7.1 Over Temperature Protection

If the XL125 is operated without adequate cooling, it will sense an over-temperature condition and shut itself down. It will not restart until it has cooled down to below its maximum operating temperature and the AC power is turned off and back on.

3.7.2 Over Voltage Protection

No single fault is able to cause a sustained over voltage condition on any output. When an over-voltage condition occurs, the power supply will shut down and will not restart until AC power is turned off and back on. The XL125 will shut down under the following over voltage conditions:

Output	Minimum	Nominal	Maximum
2.5 V	2.87 V	3.15 V	3.5 V
3.3 V	3.76 V	4.2 V	4.8 V
5 V	5.74 V	6.3 V	7.0 V
12 V	13.5 V	15.0 V	16.5 V
15 V	16.87 V	18.75 V	20.6 V
24 V	27.0 V	30.0 V	33.0 V
28 V	32.4 V	36.0 V	39.6 V
48 V	54.0 V	58.0 V	64.0 V
54 V	68.7 V	67.5 V	74.3 V
56 V	63.0 V	70.0 V	77.0 V

Table 3-6 Over Voltage Protection Limits

3.7.3 Over Current Protection

Overload currents applied to any output will cause the output to shut down. The power supply will periodically attempt to restart until the over-current condition is removed. This feature is tested with an ever-increasing load at a rate of 10 A/second starting at maximum load.

Pulsating loads of 150% of the rated output can be sustained for 10-milliseconds provided the duty cycle does not exceed 10%. The total RMS power must still be limited to 125-watts.

3.7.4 Short Circuit Protection

A short circuit is defined as an impedance of less than 0.1 ohms placed between DC RETURN and any output. A short circuit will cause no damage to the power supply and will cause it to shutdown. The power supply will periodically attempt a restart until the short circuit condition is removed. After successfully restarting, the power supply will operate normally.

A short circuit on the 12V_{AUX}-12V output will not cause the power supply to shut down and the output will resume normal operation when the short circuit is removed.

3.8 Output Rise Time

All output voltages shall rise from 10% to 90% of nominal output voltage (as specified in Table 3-1) within 0.2ms to 20ms. The output voltages waveform must be a monotonic ramp from 10% to 90% of final setpoint within the regulation band under any loading conditions specified in the respective load current tables in Section 6.

For the purposes of this specification, a monotonic ramp is defined as always having a positive slope of from zero to 10*V_{out} volts/millisecond. During any 5-millisecond portion of the ramp, its slope must be greater than 5% of its rated voltage per millisecond.

3.9 Overshoot At Turn On/Turn Off

The output voltage overshoot upon the application or removal of the input mains voltage is less than 10% above the nominal voltage. No opposite polarity voltage is present on any output during turn on or turn off.

3.10 Output Transients

The maximum output voltage transient caused by step load changes will not exceed the output voltage regulation limits by more than 5%. With an AC input as specified in Section 2.1, the power supply will remain stable when subjected to the load transients described below:

- Load changes between 75% and 100% on any output
- Load changing repetition of 50 to 333 cycles per second
- Transient load slew rate = 1.0 A/microsecond
- Capacitive loading per Figure 3-6

3.11 Closed Loop Stability

The power supply is unconditionally stable under all line/load/transient load conditions including the capacitive loads specified in Figure 3-6. The power supply shall exhibit a minimum of 45-degrees phase margin and 6 dB gain margin.

3.12 Capacitive Load

The power supply will power up and operate normally with the capacitances listed in Figure 3-6 simultaneously present on the outputs.

Output Voltage	Capacitive Load (microfarads)					
	XL125: -1, -1ATX, 7, -8	-03, -05	-12	-15	-24 & -28	-48 thru -56
+2.5 V	6,000 μ F					
+3.3 V	6,000 μ F	6,000 μ F				
+5 V	10,000 μ F	10,000 μ F				
+5 V _{standby} (ATX)	100 μ F					
-12 V _{aux}	350 μ F	350 μ F	350 μ F	350 μ F	350 μ F	350 μ F
12 V	1,000 μ F		4,000 μ F			
15 V				3,000 μ F		
24 V & 28 V					2,000 μ F	
48 V, 54 V & 56 V						500 μ F

Figure 3-6 XL125 Capacitive Load

4.

General Specifications

4.1 Environmental

The XL125 meets or exceeds the following environmental specifications:

Parameter	Conditions	Specification	Remarks
Temperature	Operating	-25°C to 70°C	See cooling requirements
	Non-Operating	-40°C to 85°C	
Relative Humidity	Operating	95% Maximum	Non-Condensing
	Non-Operating	95% Maximum	Non-Condensing
Altitude	Operating	6,561 feet MSL Max.	2,000 meters
	Non-Operating	50,000 feet MSL Max.	15,240 meters
Vibration	No damage	2.4G RMS Maximum	5-500Hz, 10-min. each axis per MIL-PRF-28800F: 3.8.4.1 (Class 3,4)
		6.0G RMS Maximum	100-1,000Hz random, 10-min. vertical axis only
Mechanical Shock	No damage	30G half-sine, 11mS	Six shocks each axis per MIL-PRF-28800F: 4.5.5.4.1

Table 4-1 Environmental Specifications

4.2 Mean Time Between Failures

The calculated MTBF of all models except the XL125-1ATX is equal to or greater than 627,000 hours of continuous operation at maximum output loading and worst-case input line voltage with forced-air cooling at 25°C. The XL125-1ATX is rated at 517,000 hours under the same conditions. N2Power does not warrant the MTBF to be representative of any particular unit. The MTBF of the power supply is calculated with an 80% confidence level in accordance with Bellcore, SR-332, Issue 2. Actual failure rates vary from unit to unit.

4.3 Component Stress

The XL125 design followed these component derating guidelines: semiconductor junction temperatures shall not exceed ninety (90) percent of manufacturer's rating with an ambient of 50°C. Inductor winding temperatures shall not exceed safety agency requirements. Capacitor case temperatures shall not exceed 95% of rated temperature. Resistor power dissipation derating is greater than 30%. Component voltage and current derating is greater than 10% at 50°C.

4.4 Labeling/Marking

The power supply is marked and labeled with the N2Power logo and part number, model number, input and output specifications, production code, appropriate safety agency logos, CE mark, patent number, and country of origin. A typical label is pictured below.

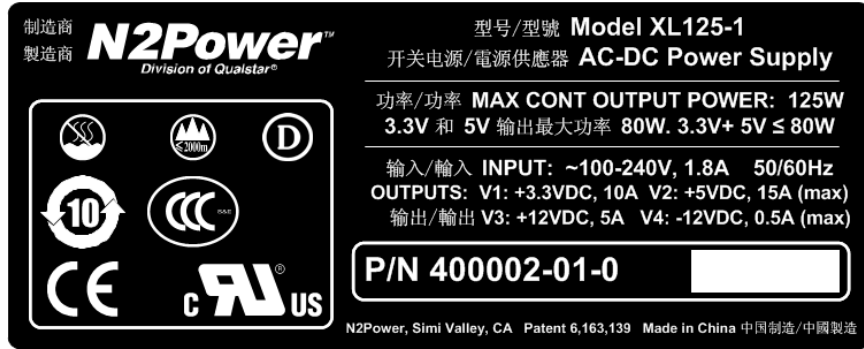

Figure 4-1 Sample XL125 Label

4.5 Net Weight

XL125:	-1ATX	-1, -7, -8	-03, -05	-12 thru -56
Pounds	0.71	0.67	0.61	0.58
Ounces	11.3	10.2	9.8	9.3
Kilograms	0.32	0.31	0.28	0.27

Table 4-2 XL125 Net Weight

4.6 Mounting

The XL125 may be mounted in any attitude but must be mounted on all four corners. No. 6 or M3 mounting hardware should not exceed .282-inches (7.16-mm) in diameter for any lockwasher, flat washer, standoff, screw head or other mounting hardware to avoid contact and maintain adequate safety agency spacing requirements with components or printed circuit board traces. The XL125 requires a safety earth connection at the mounting hole nearest J1 (See Figure 4-2).

4.7 Physical Dimensions

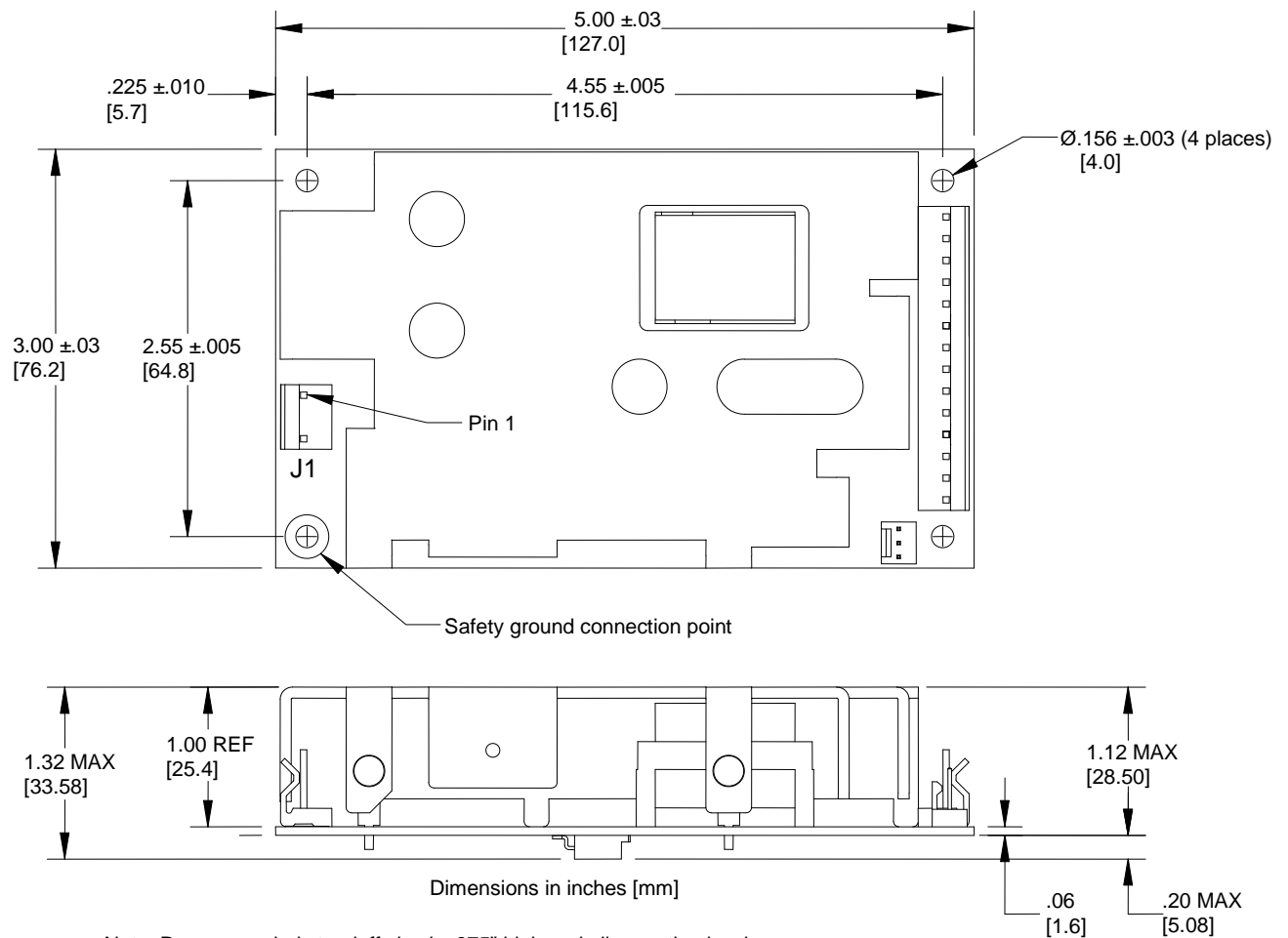

Note: Recommended standoff size is .375" high and all mounting hardware should be less than .28" in diameter. A standoff less than .375" high is acceptable when a thin insulator, 0.4mm thick (polyester, fish paper or equivalent UL rated 94V-2 minimum) is placed between the XL125 and the mounting chassis (refer to applicable UL standard for clearance requirements).

Figure 4-2 XL125 Dimensions

4.8 Mating Connectors

The user must furnish all mating connectors. The mating connectors must meet the requirements of all applicable safety agencies (notably UL). Molex™ (Molex is a trademark of the Molex Corporation) did not change their part numbers when they took the lead out of their contacts. The Molex part numbers in this section should yield RoHS compliant contacts. The largest wire size accepted by each contact should be used for all power connections to help dissipate the heat generated by the resistive connections.

Note that the female contacts that mate to the power supply are only rated for 25-30 mating cycles. Excessive mating cycles causes dramatically increased terminal resistance and heating resulting in the eventual failure of the mating terminal and possibly the header on the power supply.

CAUTION

The pin-1 location differs amongst connector manufacturers. Sometimes pin-1 differs between the header (on the power supply) and the mating housing from the same manufacturer. Disregard the manufacturer's pin-1 location and follow only the pin-1 locations in Figure 4-2 and Figure 4-3.

4.8.1 AC Input Mating Connector (J1)

The AC input connector to the XL125 is a 3-pin Molex™ (Molex is a trademark of the Molex Corporation) style header with 0.156" centers. The center pin is omitted to provide adequate insulation spacing. The Molex part numbers for the mating housing and crimp-style snap-in terminals are listed below. There may be equivalent connectors available from other manufacturers.

J1	Molex P/N
Connector Circuits (pins)	2 of 3
Mating Housing	09-50-8031
Rated Contact Current	7.0 A
Crimp Terminal (tin)	08-50-0106
Rated Wire Size	AWG 18 or 20

Table 4-3 J1 Mating Connector

4.8.2 DC Output Connector (J2)

The DC output connector is a Molex style header with 0.156” centers. The Molex part numbers for the mating housing and crimp-style snap-in terminals are listed below. There may be equivalent connectors available from other manufacturers.

J2 on XL125:	-1, -1ATX, -7, -8	-03, -05	-12 thru -56
Connector Circuits (pins)	14	10	6
Mating Housing	09-50-8141	09-50-8101	09-50-8061
Crimp Terminal (tin)	08-50-0106	08-50-0106	08-50-0106
Rated Wire Size	AWG 18 or 20	AWG 18 or 20	AWG 18 or 20

Table 4-4 J2 Mating Connectors

4.8.3 Remote Sense / Power Good Connector (J3)

The Remote Sense/Power Good connector on the XL125 is a Molex style header with 0.100” centers. The Molex part numbers for the mating housing and crimp-style snap-in terminals are listed below. There may be equivalent connectors available from other manufacturers.

J3 on XL125:	-1, -7, -8*	-1ATX, -03, -05	-12 thru -56
Connector Circuits (pins)	3	5	6
Mating Housing	22-01-3037	22-01-3057	22-01-3067
Crimp Terminal (tin, 2.5A)	08-52-0123	08-52-0123	08-52-0123
Rated Wire Size	AWG 22 to 30	AWG 22 to 30	AWG 22 to 30

* For XL125-1, 7 and 8 models only, it is recommended to use the Molex 22-01-3037 housing and not an equivalent from another manufacturer.

Table 4-5 J3 Mating Connectors

4.8.4 J4 Connector: Single Output Models

The 12V_{Aux} connector found on models XL125-03 through XL125-56 is a 2-pin Molex style header with 0.100” centers. The Molex part numbers for the mating housing and crimp-style snap-in terminals are listed below. There may be equivalent connectors available from other manufacturers.

J4 on the XL125-1,7,8 models is a single pin header for remote sensing the V2 (+5V) output. Remote sensing will help eliminate the voltage drop in the wires from the XL125-1,7,8 to the load. This pin should be connected to the +5V output at the load, not J2.

J4 on XL125:	-03 thru -56	-1, -7, -8
Connector Circuits (pins)	2	1
Mating Housing	22-01-3027	22-01-2011
Crimp Terminal (tin, 2.5A)	08-52-0123	08-52-0123
Rated Wire Size	AWG 22 to 30	AWG 22 to 30

Table 4-6 J4 Mating Connectors

4.9 Output Grounding

The DC RETURN signal may be connected to the power supply chassis ground (safety earth) at the plated through mounting hole near the input connector J1.

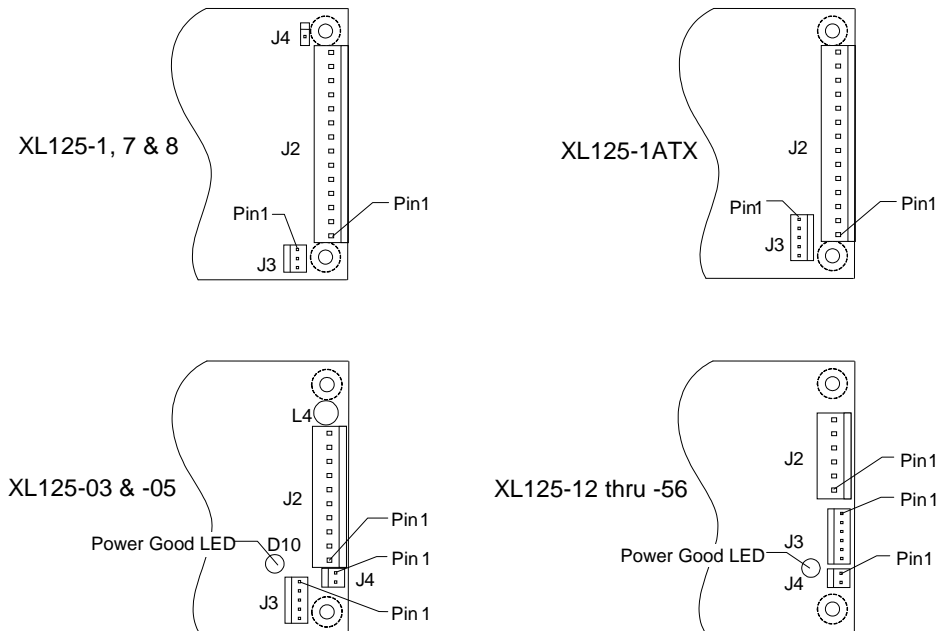

Figure 4-3 XL125 Output Connectors Layouts

4.10 Signal Pin Definitions

- There are three general output connector configurations for the XL125 Series
- Identical signal names are connected together on all connectors
- The Auxiliary 12V supply floats only on models XL125-12 through -56
- The safety ground connection is provided by the mounting screw near J1, refer to Figure 4-3 for connector and pin-1 locations
- Refer to Table 6-1 for signal level definitions

Pin	XL125-1, -1ATX, -7,-8	XL125-03, -05	XL125-12 thru -56
J1-1	AC Neutral	AC Neutral	AC Neutral
J1-2	No Pin	No Pin	No Pin
J1-3	AC Line	AC Line	AC Line
J2-1	-12V AUX (Fan)	V1 (+ Output)	V1 (+ Output)
J2-2	+12V	V1 (+ Output)	V1 (+ Output)
J2-3	V1 (+3.3V Output)	V1 (+ Output)	V1 (+ Output)
J2-4	V1 (+3.3V Output)	V1 (+ Output)	DC RETURN (0V)
J2-5	V1 (+3.3V Output)	V1 (+ Output)	DC RETURN (0V)
J2-6	DC RETURN (0V)	DC RETURN (0V)	DC RETURN (0V)
J2-7	DC RETURN (0V)	DC RETURN (0V)	
J2-8	DC RETURN (0V)	DC RETURN (0V)	
J2-9	DC RETURN (0V)	DC RETURN (0V)	
J2-10	DC RETURN (0V)	DC RETURN (0V)	
J2-11	V2 (+5V Output)		
J2-12	V2 (+5V Output)		
J2-13	V2 (+5V Output)		
J2-14	V2 (+5V Output)		
J3-1	0V Sense (-)	Current Share	DC RETURN (0V)
J3-2	V1 Sense (+)	0V Sense (-)	0V Sense (-)
J3-3	Power Good	V1 Sense (+)	V1 Sense (+)
J3-4	-1ATX only: PS_ON/	PS_OK	Current Share
J3-5	-1ATX only: +5 V _{standby}	Power Good	Power Good
J3-6			PS_OK
J4-1	Not -1ATX: V2 Sense (+)	+12V AUX (Fan)	12V AUX (+) (Fan)
J4-2	No Pin	DC RETURN (0V)	12V AUX (-) (Fan)

Table 4-7 XL125 Signal Pin Definitions

5.

Efficiency

Except for the XL125-03, the power supply will meet efficiencies of at least 85% (82% for XL125-03 and ATX models) under defined loading conditions specified in Table 5-1 with a line voltage of 230VAC and 5 CFM of cooling air at 25°C. Efficiency curves are shown in the following diagrams.

XL125:	-1 & -1ATX	-7	-8	-03	-05	-12 thru -56
V1	1.0 A	1.0 A	-	20.0 A	25.6 A	100 W
V2	7.5 A	7.5 A	8.0 A	0.0 A	0.0 A	0.0 A
V3	5.0 A	5.0 A	5.0 A	-	-	-
V4	0.0 A	0.0 A	0.0 A	-	-	-
V5	0.3 A (-1ATX)	-	-	-	-	-

Table 5-1 XL125 Output Currents at Rated Efficiency

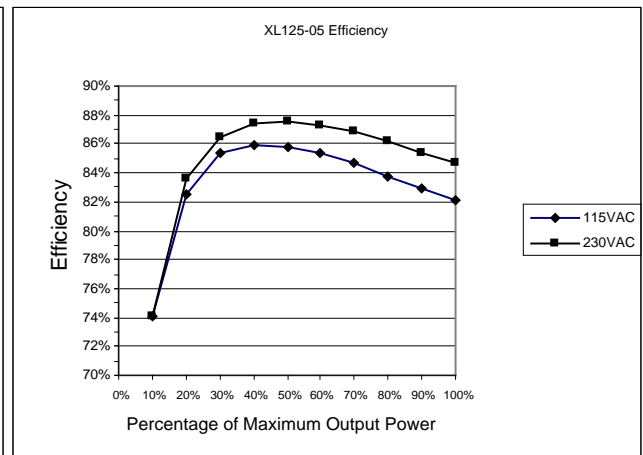
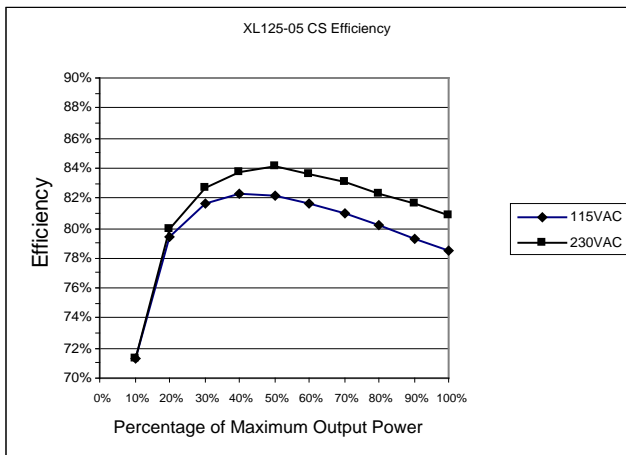
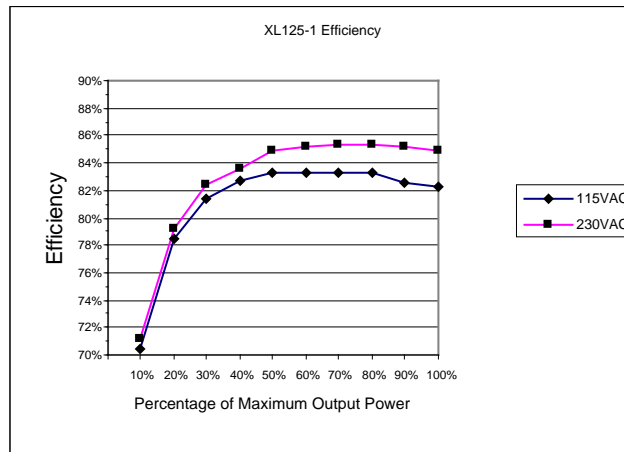

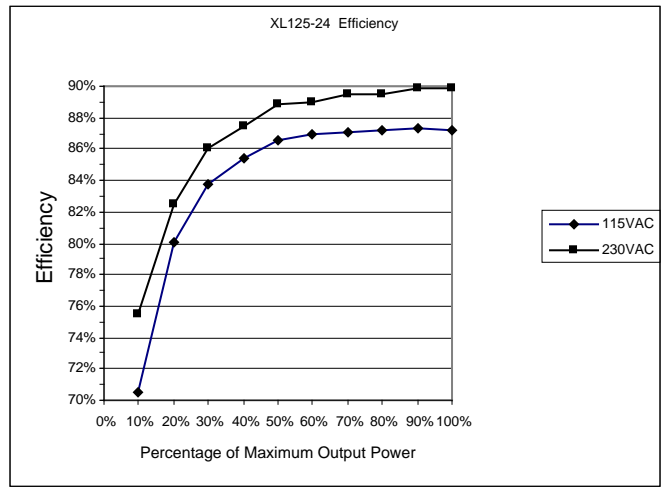
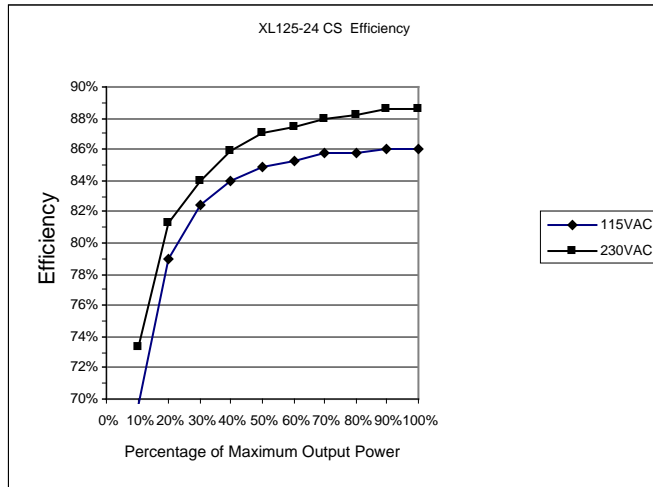
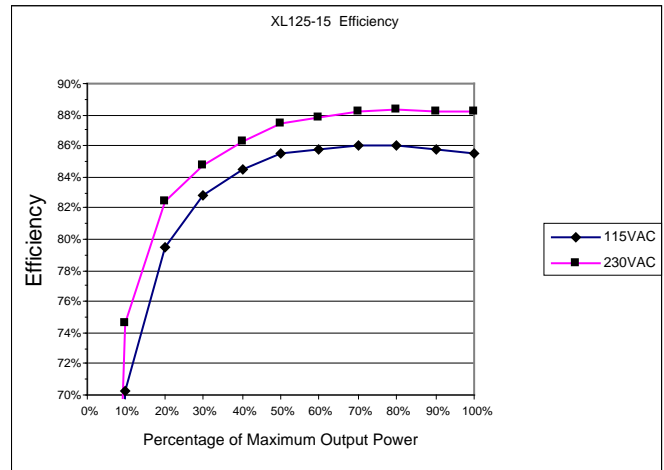
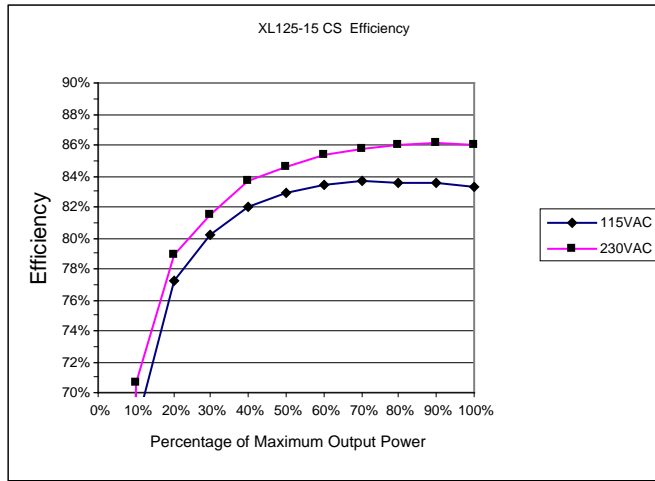
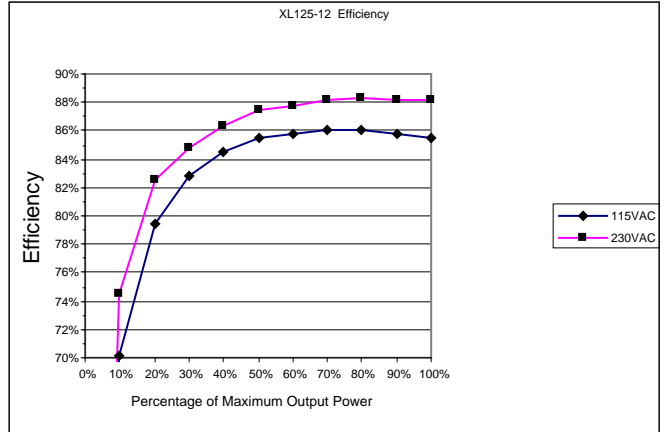
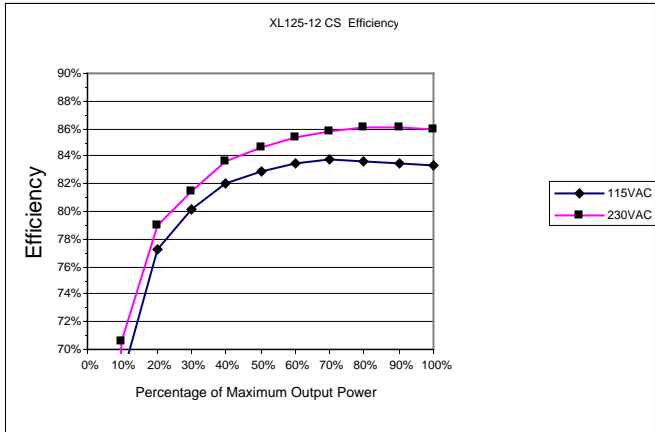

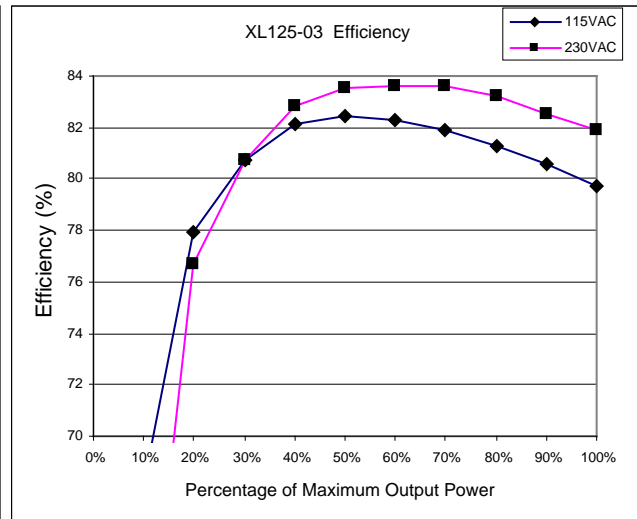
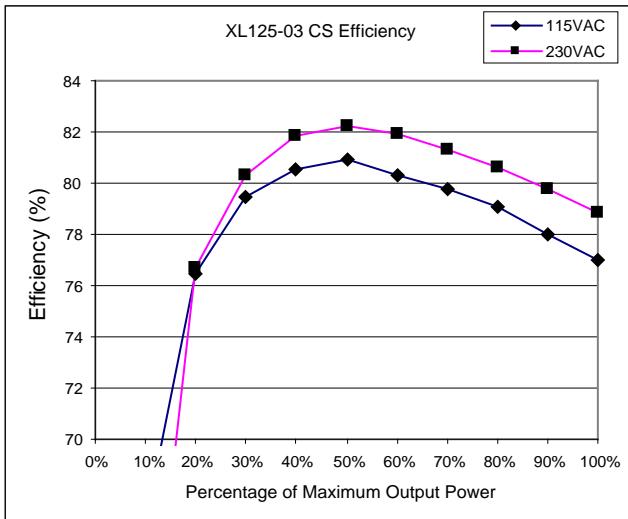
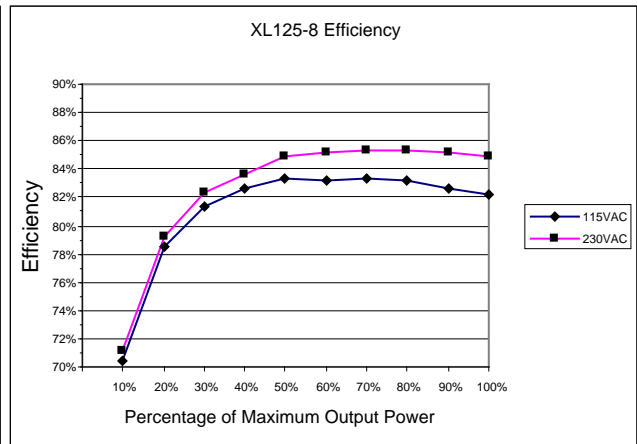
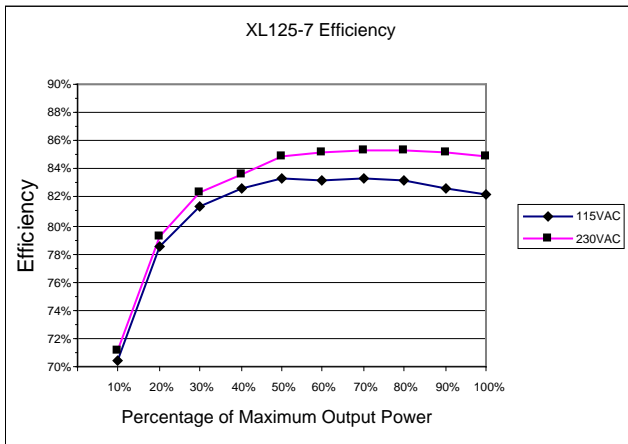
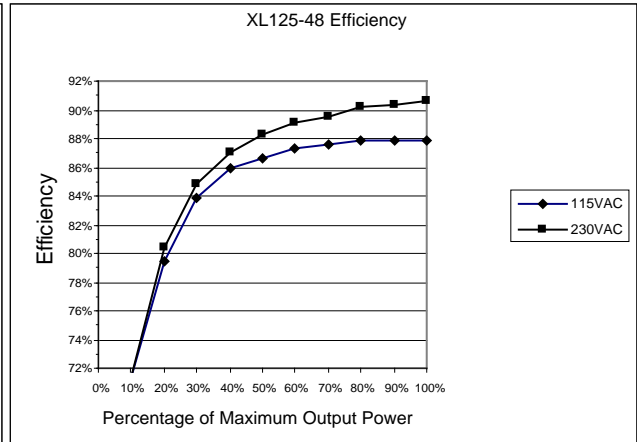
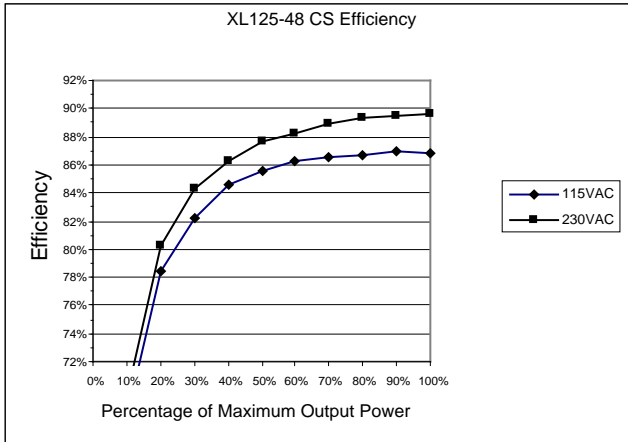

6.

Timing and Control

6.1 Power Supply Timing

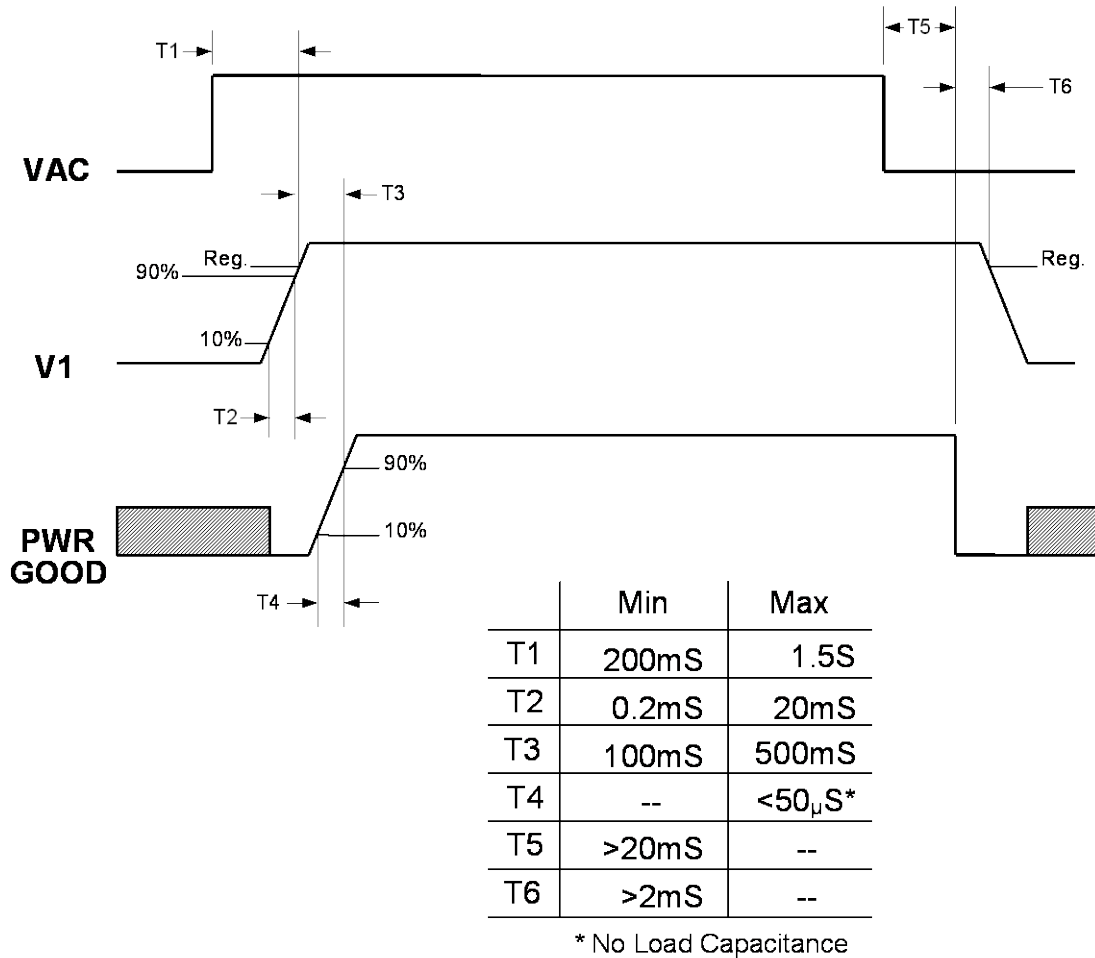

Figure 6-1 XL125 Timing Diagram

6.2 Power Good Signal/PS_OK Signal/Remote ON Input

6.2.1 Power Good (PG)

The Power Good (PG) Signal provides a high logic level to indicate that sufficient time has expired for the DC outputs to be within their regulation limits and that sufficient mains energy is stored by the power supply to ensure continuous power operation within specification for the duration of the hold-up time. When the AC mains power is removed for a period longer than 20ms, the Power Good Signal transitions to a low

logic level. XL125-1, -7 and -8 models add a TTL-compatible pullup resistor on just the Power Good output.

6.2.2 PS_OK

The PS_OK signal is the logical complement of the Power Good signal and both signals are driven by open-collector transistors.. The electrical specifications for the Power Good and PS_OK outputs are described in Table 6-1.

6.2.3 PS_ON

On the XL125-1ATX, the V1 through V4 outputs are enabled whenever the PS_ON input (J3 pin-4) is grounded to DC RETURN (or J3 pin-1). Opening the PS_ON/ input will disable the four outputs and cause the Power Good output to go false. The PS_ON/ input has an internal 1K-ohm pull-up resistor connected to +5 V_{standby}

Signal Type	TTL Compatible
Low Logic Levels	<0.4 V when sinking 4 mA
High Logic Levels	Open Collector Output (see next)
Power Good output	High true (open) when conditions described above are met
Power Good Pull-up Resistor	TTL-compatible pull-up only on XL125-1, -7 and -8 models
Power On Delay	Between 100 and 500ms after V1 outputs reaches regulation
Power Down Warning	>2 mS before V1 reaches minimum regulated output
Rise Time	<50 μS from 10% to 90% point.
PS_OK Output	Logical complement of Power Good signal. Open collector output without a pull-up resistor
PS_ON/ (input)	Operate < 0.8V, Standby > 2.0V, Load: 1.0 K pull-up to +5 V

Table 6-1 XL125 Status and Control Signal Specifications

6.3 Power Good LED

A green LED on XL125-03 through -56 models (single output models) illuminates whenever the Power Good signal is true (high). See Figure 4-3 for the LED location near the output connector.

6.4 Power Sequencing: XL125-1 and XL125-7

The +12V and +5V output voltages are equal to or greater than the V1 (+2.5V or +3.3V) output voltage at all times during power up and normal operation. The time between the +5V output reaching minimum in-regulation voltage and the V1 output reaching minimum in-regulation voltage shall be less than 20 milliseconds.

6.5 Voltage Hold-Up Time

The power supply will maintain output regulation per Table 3-1 despite a loss of input power at 100VAC/50Hz and 230VAC/47Hz at maximum continuous output load for a minimum of 22 milliseconds.

7.

Ordering Information

N2Power is in the process of changing the model numbering system for single-output power supplies to reflect the actual output voltage instead of a code. The following table provides the N2Power part numbers that should appear on your purchase order and will appear on any N2Power correspondence:

New Model Number	V1	N2Power Part Number	Legacy Model Number
Without active current sharing			
XL125-1ATX	3.3 V	400002-71-3	XL125-1ATX
XL125-1	3.3 V	400002-61-4	XL125-1
XL125-7	2.5 V	400008-61-1	XL125-7
XL125-8	none	400009-61-9	XL125-8
XL125-03	3.3 V	400010-03-9*	N/A
XL125-05	5.0 V	400003-08-3*	N/A
XL125-12	12 V	400004-67-7	N/A
XL125-15	15 V	400005-62-5	N/A
XL125-24	24 V	400006-68-0	N/A
XL125-28	28 V	400006-66-4	N/A
XL125-48	48 V	400007-63-9	N/A
XL125-54	54 V	400071-67-6	N/A
XL125-56	56 V	400071-68-4	N/A
With active current sharing			
XL125-03 CS	3.3 V	400010-01-3*	XL125-9
XL125-05 CS	5.0 V	400003-01-8*	XL125-2
XL125-12 CS	12 V	400004-61-0	XL125-3
XL125-15 CS	15 V	400005-61-7	XL125-4
XL125-24 CS	24 V	400006-61-5	XL125-5
XL125-28 CS	28 V	400006-64-9	XL125-5 S68
XL125-48 CS	48 V	400007-61-3	XL125-6
XL125-54 CS	54 V	400070-69-4	N/A
XL125-56 CS	56 V	400070-70-2	N/A

* Refer to CB report E211115-A1-CB, rest of the models refer to E211115-A2-CB report.

Table 7-1 XL125 Part Numbers

All XL125 power supplies are RoHS compliant For warranty information refer to www.n2power.com . Direct all questions, orders or requests for quotation as follows:

N2Power Order Desk: