

# altronic<sup>®</sup> III

## IGNITION SYSTEM FOR INDUSTRIAL ENGINES

- UP TO 16  
OUTPUTS PER UNIT
- PROVEN RELIABILITY  
AND HIGH TEMPERATURE  
CAPABILITY
- EASE OF MAINTENANCE WITH  
REMOVABLE BACK COVER
- HIGH OUTPUT OPTION
- LONG SPARK DURATION  
COIL OPTION
- ELECTRONIC, VARIABLE  
TIMING OPTIONS

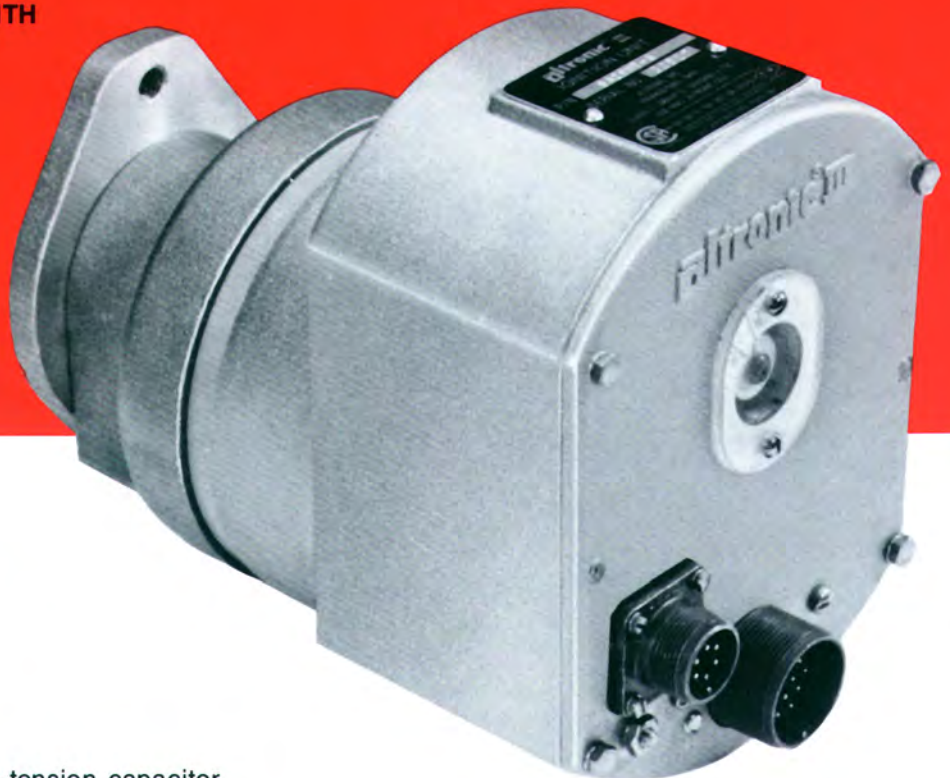

**Factory  
Mutual  
System**

Certified Approved  
CLASS I, GROUP D, DIVISION 2

Altronic III is a self-powered, low-tension, capacitor discharge ignition system for 3 to 16 cylinder, 2 or 4-cycle engines. Powered from a 12-pole permanent magnet alternator, Altronic III provides superior performance throughout the engine's operating range. Its basic design features - permanent magnet alternator; easily serviced, removable back cover containing all electronics; and simple, reliable electronic circuitry - have made Altronic III the standard of the industry on medium to large industrial gas engines.

Altronic III's mechanical design matches the long life inherent in the electronic circuitry. Sealed ball bearings used throughout are large and under-loaded. The alternator has a smooth rotating cycle - a characteristic which contributes to prolonged

bearing and gear life. The synthetic elastomer couplings used provide long life with minimal wear and also dampen out much of the engine drive train vibration.

Options available for the Altronic III ignition system include three output levels and standard or long spark duration coils to match the needs of every application. There are a variety of shielded ignition components available for use in Class I, Group D, Division 2 areas. Complete electronic control of ignition timing is also offered with Altronic III over a range of 10 degrees, 2-cycle or 20 degrees, 4-cycle.

**SUPERIOR  
PERFORMANCE**

**LOW MAINTENANCE  
DESIGN AND  
EASE OF  
SERVICE**

**ELECTRONIC  
TIMING  
CAPABILITY**

Altronic III provides strong performance over the entire engine operating range. A low starting speed capability - typically 30 RPM, 2-cycle or 60 RPM, 4-cycle - is made possible by the 12-pole permanent magnet alternator. Delivered spark duration at typical engine KV demand levels is a critical factor for smooth, consistent engine performance. Altronic III's 501 061 standard coil gives excellent performance and the 591 010 long duration coil truly gives the extended duration required for today's lean mixture or non-standard fuel applications.



# 23

Altronic III has been designed to be as maintenance-free as possible. Tens of thousands of Altronic III units in successful field operations since 1968 have resulted in a design evolution to the present field-proven form. All bearings are sealed ball bearings. The internal gears are large and underloaded. When service is required, Altronic III is designed to make it easy. All electronic components are mounted on the Back Cover assembly which is easily removed from the Alternator section of the unit.

Altronic III is available with a complete line of electronic timing capability to optimize engine performance, fuel economy and engine exhaust emissions. The basic Altronic III unit has an added connector to allow the timing signals to be processed by an external control unit. The internal components of the Altronic III unit remain unchanged; the same service parts apply as with standard, fixed timing units.

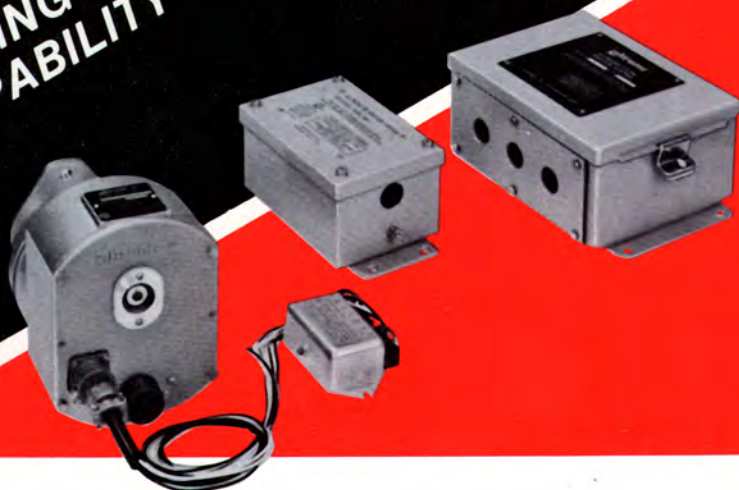

#### TIMING UNIT

#### APPLICATION

381 601	Dual timing settings or simple manual timing adjustment
381 610	Timing vs RPM - curve custom programmed to application
381 650	Crankshaft-referenced timing with 4-20 ma timing control
381 650 with EPC-200 Controller	Crankshaft-referenced timing with control vs. RPM and four (4) other analog inputs; the EPC-200 also provides electronic control of engine air/fuel ratio

IGNITION COIL	STANDARD OUTPUT		HIGH OUTPUT	
	MAX. KV	SPARK DURATION	MAX. KV.	SPARK DURATION
501 061	34KV	250 usec @ 10KV	40 KV	360 usec @ 10KV 200 usec @ 20KV
591 010	34KV	450 usec @ 10KV	40 KV	550 usec @ 10KV 360 usec @ 20KV

## UNSHIELDED COILS

501 061  
STANDARD  
591 010  
LONG DURATION

Altronic III  
Alternator  
Section

Altronic III  
Back Cover

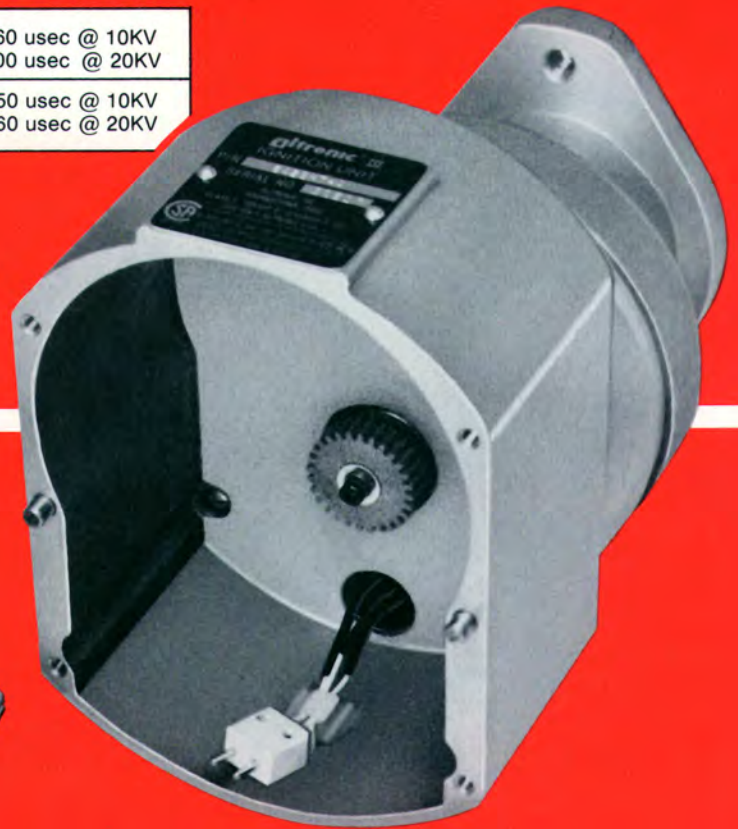
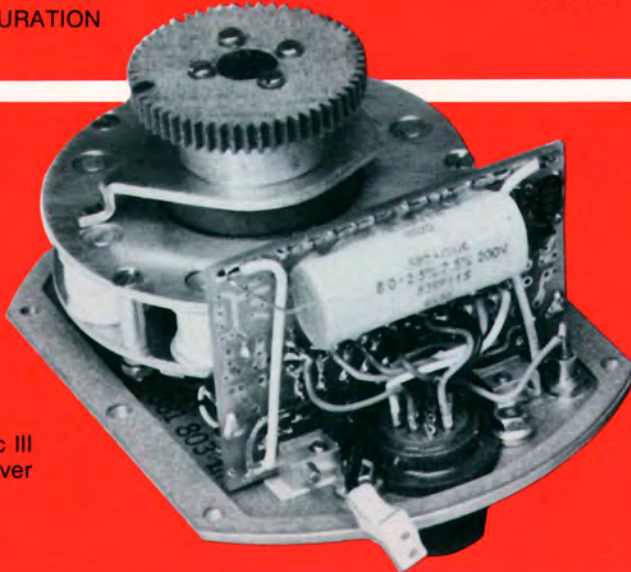

### 381 601 — DUAL TIMING SETTING

The 381 601 timing unit is designed for dual-gas or dual-load applications requiring two different timing settings. The adjustment screw is used to set the differential up to a maximum of 10 degrees (2-cycle) or 20 degrees (4-cycle). The 381 601 series can also be used for simple manual adjustment of ignition timing.

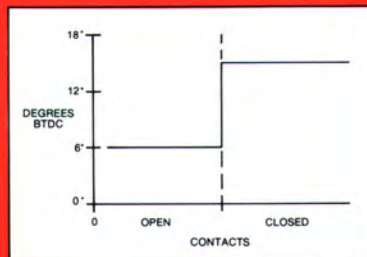

381 601

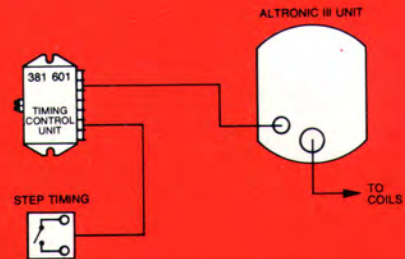

### 381 610 — TIMING VS. RPM

The 381 610 timing unit can be programmed with virtually any shaped curve vs. RPM within a range of 10 degrees (2-cycle) or 20 degrees (4-cycle). Ignition timing is automatically and accurately varied as a function of engine RPM for improved fuel economy and/or reducing engine detonation. Power is totally from the Altronic III unit; no other power or signal source is required. The user must supply the desired timing curve vs. RPM.

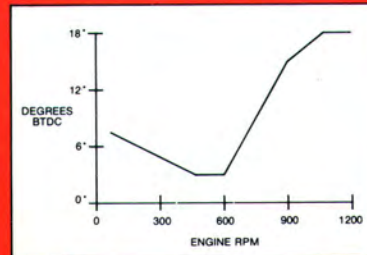

381 610

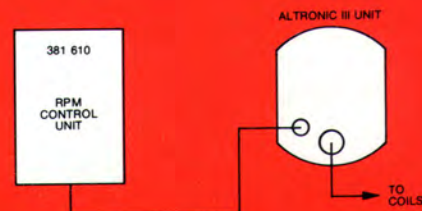

### ALTRONIC III-CPU

#### 381 650 — TIMING VS. 4-20 MA

The Altronic III-CPU system introduces crankshaft-referenced timing and interface to computer control sources. The system eliminates timing variation caused by magneto drive train variations and allows timing to be optimized for conditions of load, speed, temperature, etc.

A CPU control unit and two magnetic pick-ups (sensing ring gear teeth or drilled holes) are added to the basic Altronic III unit. Two modes of external timing control are provided: a user-settable timing step-change initiated from external switch contacts and continuous control from a 4-20 ma loop signal. See form All-CPU for complete system details.

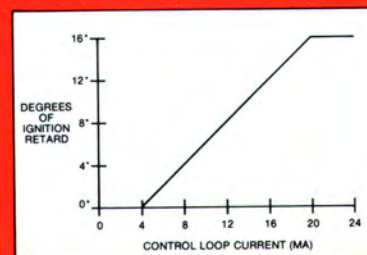

381 650

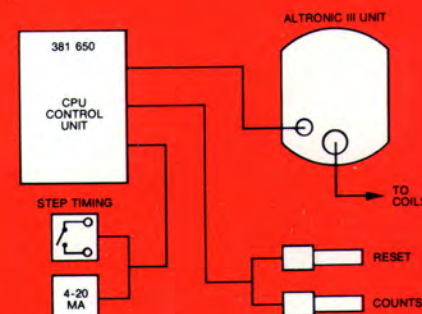

# ALTRONIC SHIELDED COILS

Altronic shielded coils cover all application requirements with external types (standard and long duration) and integral coils mounting directly to either 1"-20 or 13/16"-20 thread spark plugs.

**FLANGE-MOUNT COIL**  
591 012  
LONG DURATION



**SHIELDED COILS**  
501 061-S  
STANDARD  
591 010-S  
LONG DURATION



**INTEGRAL COILS**



591 007  
1"-20 THREAD  
5.6" LENGTH



591 011A (not shown)  
13/16"-20 THREAD  
6.1" LENGTH

591 011B  
13/16"-20 THREAD  
10.8" LENGTH

## ALTRONIC III APPLICATIONS

- AJAX\*
- BUDA
- CATERPILLAR\*
- CHICAGO PNEUMATIC
- CLARK
- CLIMAX
- COOPER BESSEMER
- CUMMINS\*
- DETROIT DIESEL\*
- DEUTZ\*
- DAIHATSU\*
- DORMAN\*
- GANZ MAVAG\*
- INGERSOLL RAND
- JENBACHER\*
- KOSAN FRICHS\*
- M.A.N.-BRONS\*
- M.E.P.
- MWM\*
- NIIGATA\*
- ROILINE
- SACM\*
- SUPERIOR\*
- WAUKESHA\*
- WORTHINGTON
- YANMAR\*

\* Used on OEM basis by this engine manufacturer.

## SHIELDED COMPONENTS

Shown below are the various shielded coil assembly and lead options. Altronic primary and spark plug cables are fabricated from teflon tubing covered with stainless steel braid. All components are CSA certified/FMR approved for Class I, Group D, Division 2 hazardous locations.

**SHIELDED COIL 501061-S, 591010-S**

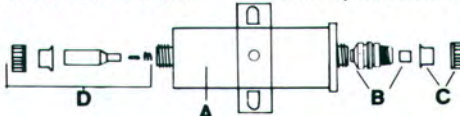

COIL NO.	DESCRIPTION	INCLUDES
501 061-S	Shielded Coil - Standard	A
591 010-S	Shielded Coil - Long Duration	A
501 061-S-2	Coil w/Pri. & Sec. Fittings	A + B + C + D
591 010-S-2	Coil w/Pri. & Sec. Fittings	A + B + C + D
501 061-S-5	Coil w/Sec. Fittings	A + D
591 010-S-5	Coil w/Sec. Fittings	A + D

**INTEGRAL COIL**

591 007, 591 011A, 591 011B

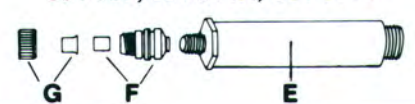

COIL NO.	DESCRIPTION	INCLUDES
591 007	Coil 1"-20 x 5.6" Lg.	E
591 011A	Coil 13/16"-20 x 6.1" Lg.	E
591 011B	Coil 13/16"-20 x 10.8" Lg.	E
591 007-2	Coil w/Pri. Fittings	E + F + G
591 011A-2	Coil w/Pri. Fittings	E + F + G
591 011B-2	Coil w/Pri. Fittings	E + F + G

**SHIELDED PRIMARY CABLE**

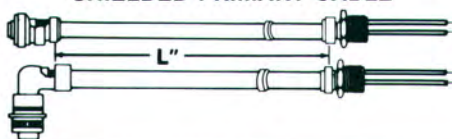

PART NO.	CONNECTOR TYPE	LENGTH L"
593022-L"	Straight	6", 9", 12", 15", 18"
		24", 30", 36", 42"
593027-L"	Right Angle	48", 54", 60", 72"

**SHIELDED SPARK PLUG LEAD**

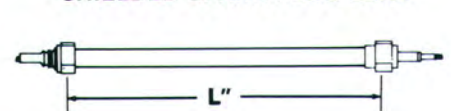

PART NO.	SPARK PLUG-WEEL DEPTH	LENGTH L"
593020-L"	3/4" - 20 1"	10", 13"
593030-L"	3/4" - 20 2"	16", 18"

**altronic inc.**

712 TRUMBULL AVENUE • GIRARD, OHIO 44420 / (330) 545-9768 / FAX (330) 545-9005