

GB

GB-ER SERIES (SR138R)

The GB-ER series combines Sony's classic Magnescale technology and legendary durability with a built-in reference point.

- Excellent durability against workshop conditions - resistant to oil, dirt, shock and vibration.
- Compact design for a space-saving installation.
- Accuracy: $(5+5L/1000)\mu\text{m}$
- Resolution: $0.5\mu\text{m}$
- Simple structure should be conducive to long life.

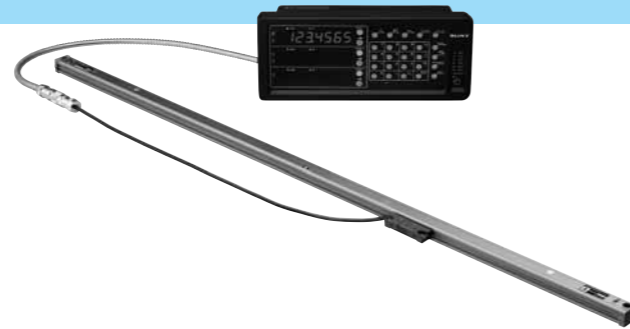

Dimensions

SR138R (Model name of the scale itself)

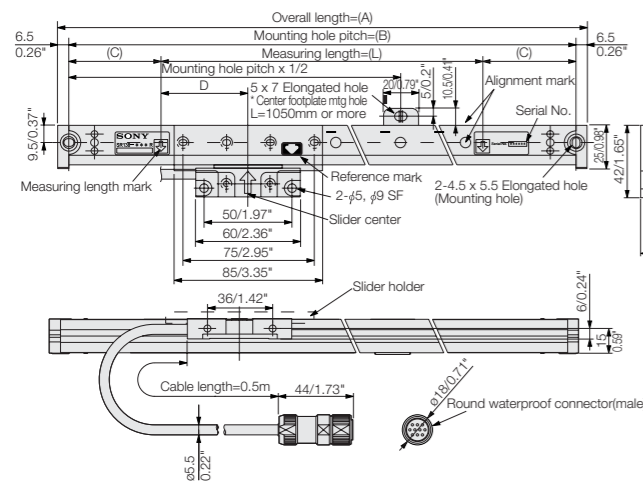

CH04 (Name of accessory cable model)

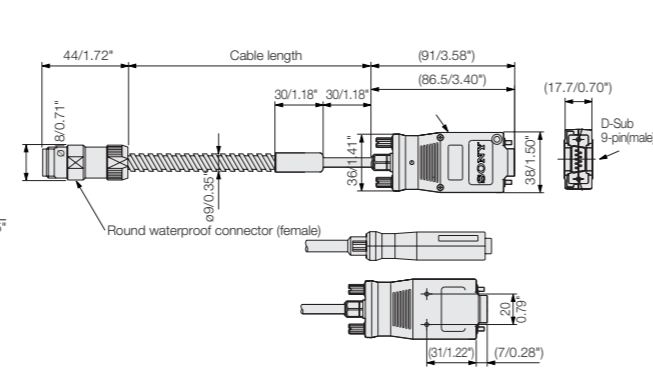

LH70/71

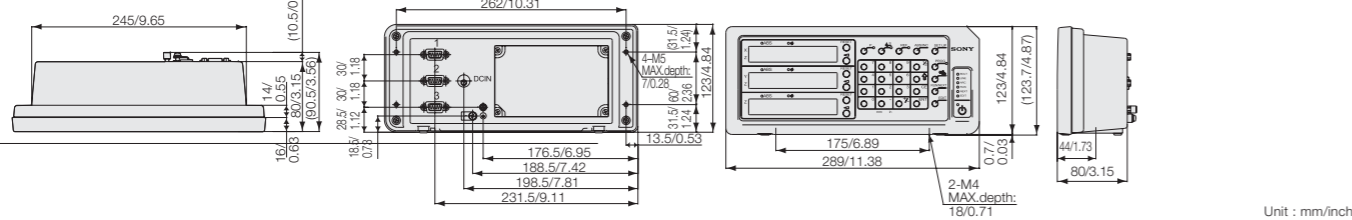

Specifications

Model		GB-ER
Measuring length		50/100/150/200/250/300/350/400/450/500/550/600/650/750/850/950/1050/1250/1400/1600/1850/2050/2200 mm
Scale length	Overall length	ML + 104mm (50 to 200mm) ML + 120mm (250 to 2200mm)
	Max.travel	ML + 14mm (50 to 200mm) ML + 30mm (250 to 2200mm)
	With or without Centerfootplate	Without (50 to 950mm) With (1050 to 2200mm)
Accuracy at 20°C		$(5 + 5L / 1000) \mu\text{m}$
Reference point		Standard:Center point, User-selected point (A/B quadrature)
Mounting parallelism		$\pm 0.1\text{mm}$
Expansion coefficient		$(11 \pm 1) \times 10^{-6} / ^\circ\text{C}$
Operating temperature		0 to 40°C
Storage temperature		-20 to 50°C
Cable length		3m
Protective design grade		Scale:IP65 Interface unit:IP30
Input/Output signal	Output signal	A/B/Z quadrature
	Power supply	DC + 5V $\pm 5\%$
	Connector	D-sub 9 pin
Resolution		$0.5 \mu\text{m}$
Response speed	Scale signal	60m/min
	Reference signal	60m/min
Power consumption		Max. 200mA

* Specifications and appearance are subject to should be charge with prior notice.

ML:Measuring length[mm]

System configuration

Milling machine

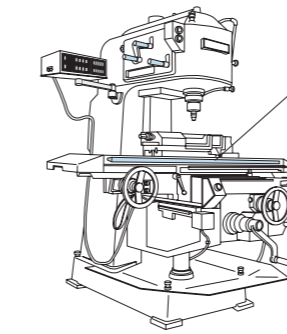

Scale unit GB-ER series

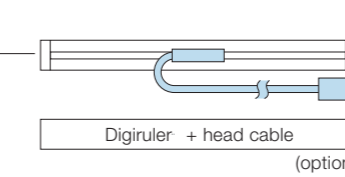

Display unit LH71A/72 series

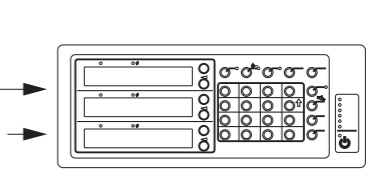

Extension cable (option) CE10-01C (1m)
Used by connecting to the cable part of the scale unit. -03C (3m)
-05C (5m)
-10C (10m)

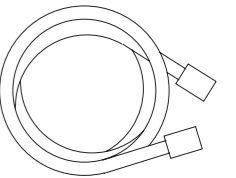

Lathe

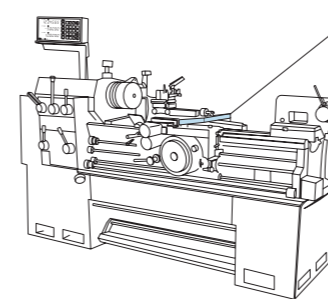

Scale unit GB-ER series

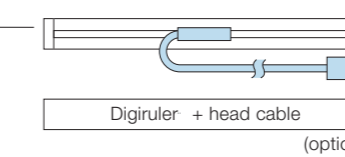

Display unit LH71A/72 series

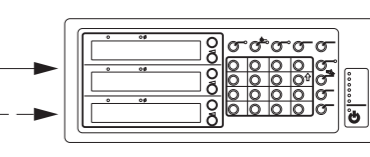

Counter table LZ7 (option)

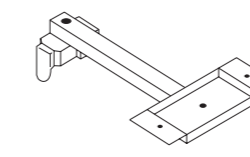

LZ8 (option)

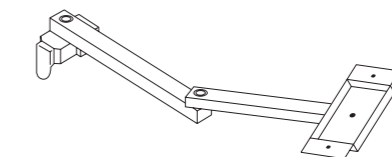

LZ9 (for lathe) (option)

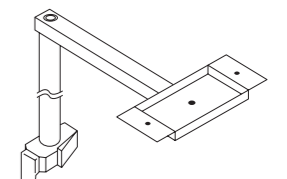

GB series connection example

