



WORLDWIDE NO. 1

AIRPORTS

DISTRIBUTION CENTRES

DISTRIBUTORS/DEALERS

FOOD PROCESSING

GENERAL INDUSTRY

MEDICAL

MISCELLANEOUS



Efficient cargo handling starts off with

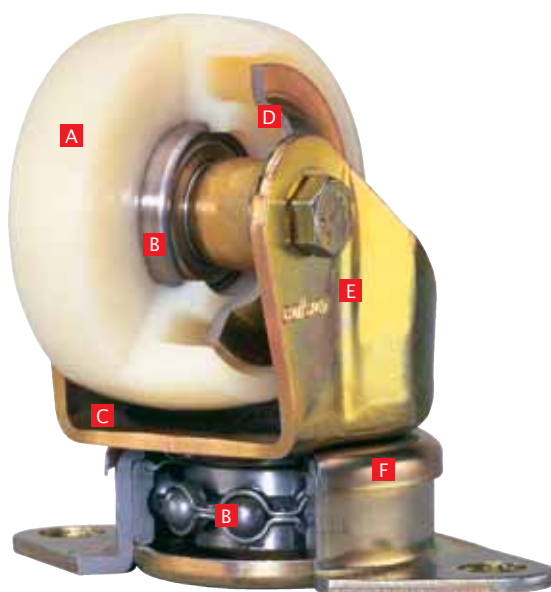

- A** Low wear and shock-resistant nylon 6.6 wheel
- B** Maintenance free, sealed precision ball bearing for low rolling effort
- C** Plastic sealing cap drains water in an efficient way and prevents corrosion
- D** Integrated bushing/threadguard for a very efficient sealing
- E** Robust pressed-steel fork with anti corrosion coating
- F** Effective labyrinth-seal for maintenance free swivelling motion

- Standard cargo castor

Air cargo handling is of paramount importance in today's world, requiring efficiency, reliability and speed even under high loads and extreme weather conditions. That is where Colson Cargo Castors play a major role.

COLSON CARGO CASTORS: RELIABILITY TURNS ON QUALITY

The quality of Colson Cargo Castors is based on a combination of:

- **precise and innovative design**
- **quality of materials**
- **quality of manufacturing**

End results: a Colson castor with a load capacity of 250 kg, with a high resistance to shock loads and a long service life. The precision ball bearings in both wheel and swivelhead secure a low rolling- and swivelling effort, enabling easy manoeuvring of the freight on loaderdecks. Newly developed seals for wheel and fork guarantee maintenance freecastors. To prevent corrosion, the electrolytically zinc plated castor is given an additional yellow passivated coating.



- Dolly with standard Colson cargo castors

Colson Cargo Castors



- Standard cargo castor with attached toe-guard

- Standard cargo castor



- Standard cargo castor with attached toe-guard



- Standard cargo castor with integrated toe-guard



FIELD TESTS

After lengthy laboratory testing on service-life, maximum load capacity, shock resistance and rolling and swivelling effort, Colson products are submitted to severe field tests for a period of at least six months. These tests include various types of Ground Support Equipment, in various countries and under all types of weather conditions. It is not until the products have passed all these tests that they are released for volume production and marketing.

It is therefore that Colson Cargo Castors prove their reliability 24 hours per day, every day.



- MOBRA - standard cargo castor with toe-guard fixed in mounting bracket

- CargoDisk® cargo castor with low building height





- MOBRA – cargo castor with toe-guard fixed in mounting bracket

MOBRA

The product consists of a mounting bracket that incorporates a standard toe-guarded cargo castor. The advantages for the fabricators and users of sorting decks, are numerous:

- **New sorting decks only require an upper deck.**
The lower deck, normally used for mounting the castors, becomes superfluous.
- **Simplifies mounting.**
MOBRA doesn't need bolts and nuts.
- **No hassle of replacing damaged castors.**
Just take them out and push a new one into the standardized holes of the upper deck.
- **Procurement and logistics are simplified.**
This new patented MOBRA unit makes air cargo handling more cost efficient and reduces maintenance cost considerably.



- Sorting deck mounted with the MOBRA



- CargoDisc®

CargoDisc®

The latest development in our range of cargo castors is the CargoDisc®. Additional to the same advantages of the MOBRA, easier and more economically mounting and maintenance, is the overall low building height. There is no more space needed than the 58 mm wheel diameter, to build in this product into your GSE equipment. Specially engineered for applications like high loaders, dollies and those parts within air cargo centers where a low building height is demanded.

NEW



Colson Cargo Castors

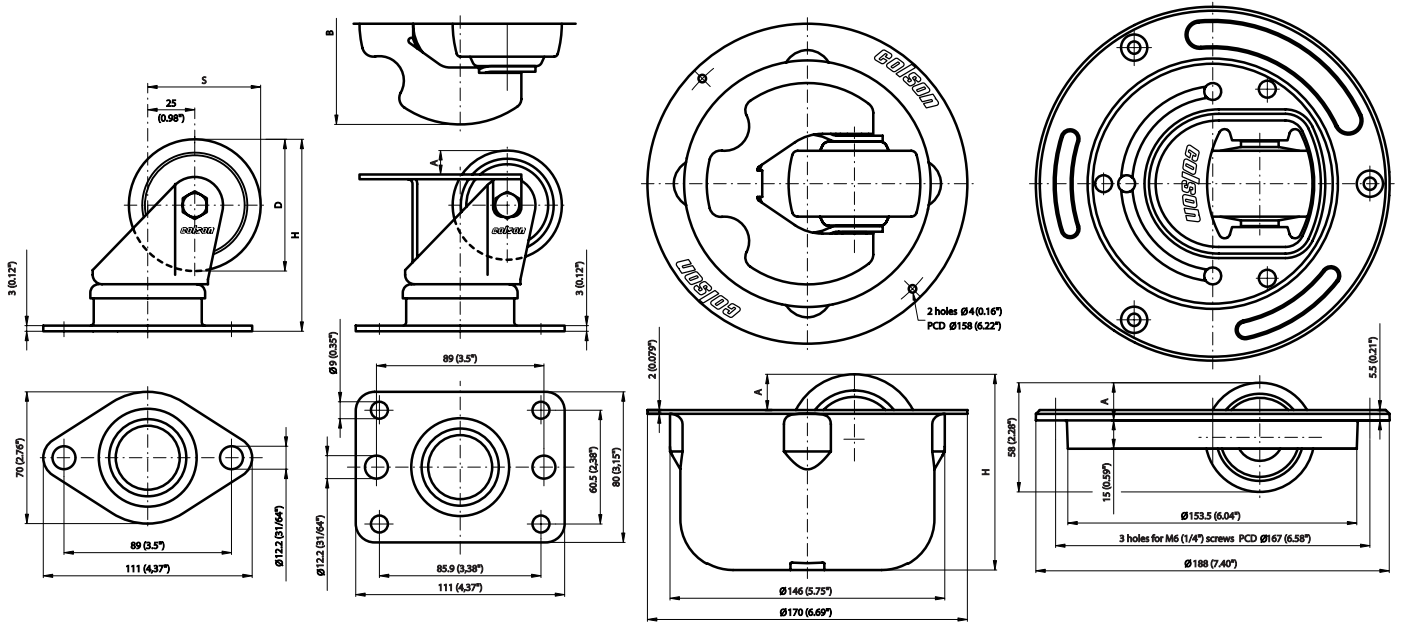

COLSON CARGO CASTOR PROGRAMME

ARTICLE NUMBER	D	H	S	A	B	TOP PLATE	LOAD capacity	WEIGHT
	mm	mm	mm	mm	mm		kg	kg
Standard cargo castors								
JBPN 058-CC1/A	58	96	54			Diamond	250	0,65
JBPN 070-CC1/A	70	102	60			Diamond	250	0,71
JBPN 058-CC1/A-R	58	96	54			Rectangular	250	0,72
JBPN 070-CC1/A-R	70	102	60			Rectangular	250	0,78
Standard cargo castors with attached toe-guard								
JBPN 058-CC1/AT12,7	58	96	54	12,7	107	Diamond	250	0,75
JBPN 058-CC1/A-RT12,7	58	96	54	12,7	107	Rectangular	250	0,81
JBPN 058-CC1/AT16	58	96	54	16,0	107	Diamond	250	0,75
JBPN 058-CC1/A-RT16	58	96	54	16,0	107	Rectangular	250	0,81
JBPN 070-CC1/AT12,7	70	102	60	12,7	107	Diamond	250	0,81
JBPN 070-CC1/A-RT12,7	70	102	60	12,7	107	Rectangular	250	0,87
JBPN 070-CC1/AT18,7	70	102	60	18,7	107	Diamond	250	0,81
JBPN 070-CC1/A-RT18,7	70	102	60	18,7	107	Rectangular	250	0,87
JBPN 070-CC1/AT22	70	102	60	22,0	107	Diamond	250	0,81
JBPN 070-CC1/A-RT22	70	102	60	22,0	107	Rectangular	250	0,87
Standard cargo castors with integrated toe-guard								
JBPN 058/2186588	58	96	54	18,7	120	Rectangular	250	0,86
JBPN 070/2184447	70	102	60	18,7	140	Diamond	250	1,08
Mounting bracket with standard cargo castor and attached toe-guard								
MBPN 058 MOBRA *	58	98	54	12,7	107		200	1,49
MBPN 070 MOBRA *	70	104	60	18,7	107		200	1,55
Mounting bracket with standard cargo castor and integrated toe-guard								
MBPN 058/2184387 *	58	96	54	16,7	120		200	1,54
CargoDisc® low height								
CDPN 058-CC2/A Obsolete!!	58	58	54	20			200	0,90

1 inch = 25.4 mm 1 pound (Lbs) = 0,45 kg

* Mounting bracket (MOBRA) needs a hole in the sorting deck of at least 146,5 mm, maximum 147,5 mm.

- Notes:
- Temperature range - 30°C to + 80°C. (-20°F to +180°F)
 - For temperatures below - 30°C (-20°F) please contact Colson
 - Overall dimensions interchangeable with most current types of cargo castors
 - Cargo castor to be mounted on a flat and solid mounting surface
 - Mounting bracket (MOBRA) is patented: NL-patent 1018366

Colson Europe 2007

The content of this leaflet are the copyright of the publishers and may not be reproduced (even extracts) unless permission is granted. Every care has been taken to ensure the accuracy of the information contained in this leaflet but no liability can be accepted for any errors or omissions.

Continuous product improvement may cause a change in the specifications quoted in this publication

Copyright Colson Europe 2007
Brochure B 0701 E 1.0

COLSON EUROPE B.V.

Generatorstraat 11
3903 LH Veenendaal
P.O. Box 421
3900 AK Veenendaal
The Netherlands

Or contact your nearest Colson dealer.

Tel. +31(0)318 53 66 11
Fax +31(0)318 52 68 76

E-mail info@colson-europe.com
Internet www.colson-europe.com



INDUSTRIAL SOLUTIONS

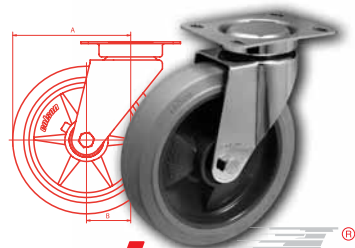

colson®

WORLDWIDE NO. 1