

RT9420

0-90° to 0-50 Turns • 0..20mA • 4..20mA

Industrial Grade Rotational Position Sensor
 Absolute Rotary Position up to 50 turns
 Aluminum or Stainless Steel Enclosure Options
 IP68 / NEMA 6 • Hazardous Area Certification



GENERAL

Full Stroke Range Options	0-0.25 to 0-50 turns
Output Signal Options	4...20 mA (2-wire) and 0...20 mA (3-wire)
Accuracy	see ordering information
Repeatability	± 0.05% full stroke
Resolution	essentially infinite
Enclosure Material Options	powder-painted aluminum or stainless steel
Sensor	plastic-hybrid precision potentiometer
Potentiometer Cycle Life	see ordering information
Shaft Loading	up to 35 lbs. radial and 5 lbs. axial
Weight, Aluminum (Stainless Steel) Enclosure	5 lbs. (10 lbs.) max.

ELECTRICAL

Input Voltage	see ordering information
Input Current	20 mA max.
Maximum Loop Resistance (Load)	(loop supply voltage - 8)/0.020
Circuit Protection	38 mA max.
Impedance	100M ohms@100 VDC, min.
Output Signal Adjustment	
Zero Adjustment	from factory set zero to 50% of full stroke range
Span Adjustment	to 50% of factory set span
Thermal Effects, Zero	0.01% f.s./°F, max.
Thermal Effects, Span	0.01% f.s./°F, max.

EMC COMPLIANCE PER DIRECTIVE 89/336/EEC

Emission/Immunity	EN50081-2/EN50082-2
-------------------	---------------------

ENVIRONMENTAL

Enclosure	NEMA 4/4X/6, IP 67/68
Operating Temperature	-40° to 200°F (-40° to 90°C)
Vibration	up to 10 g to 2000 Hz maximum

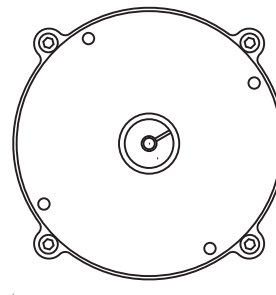

4.5" [114 mm]

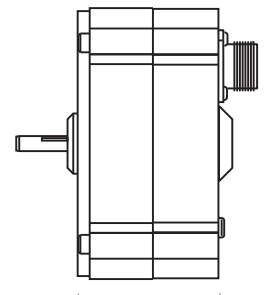

2.4" [59 mm]

The RT9420 provides rotational position feedback via 4...20 mA current loop signal. This device combines the superb linearity and resolution of a plastic-hybrid potentiometer and the durability of Celesco's 4...20mA circuit to provide an accurate and reliable electrical signal. Additionally the zero and span settings are adjustable through access holes in the housing.

This innovative sensor from Celesco, designed to meet NEMA-4 and IP67 standards, is available in full stroke ranges of 1/4 to 50 turns.

Output Signal:

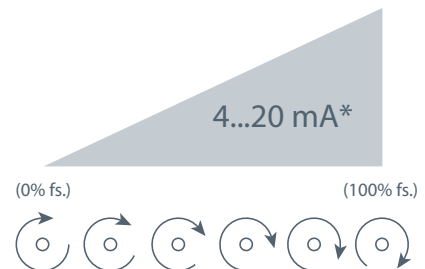

*Optional 3-wire, 0...20mA output signal available.

Outline Drawing:

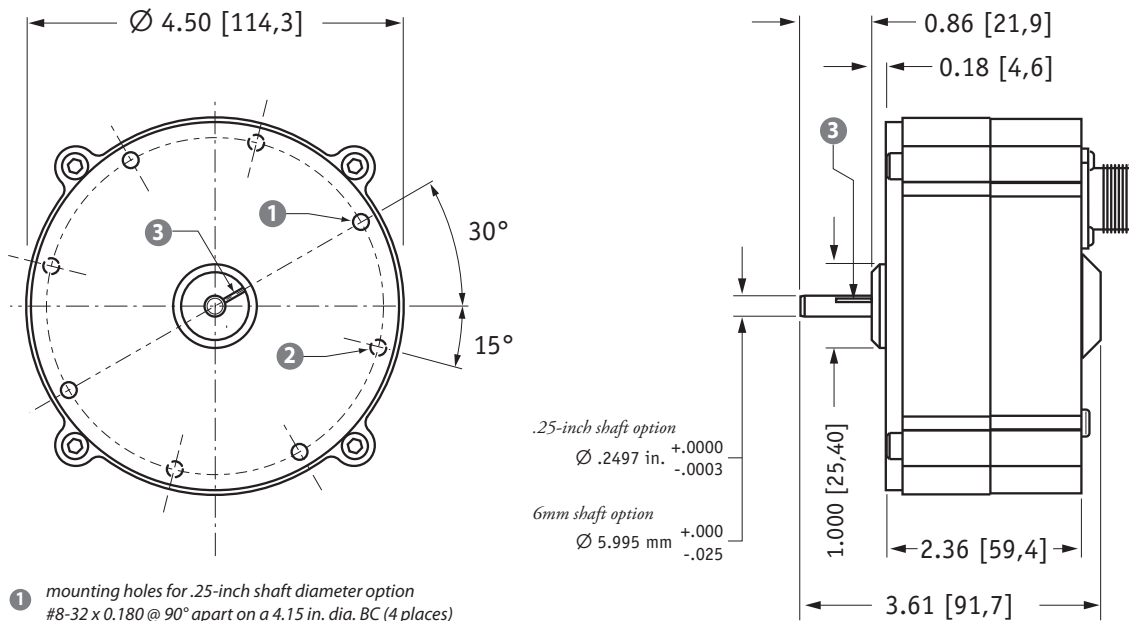

- 1 mounting holes for .25-inch shaft diameter option
#8-32 x 0.180 @ 90° apart on a 4.15 in. dia. BC (4 places)
- 2 mounting holes for 6-mm shaft diameter option
M4 x 4,5 mm @ 90° apart on a 105,4 mm dia. BC (4 places)
- 3 reference mark
full counter-clockwise position - align mark on shaft to mark
on face for start of measurement range

DIMENSIONS ARE IN INCHES [MM]
tolerances are ±0.02 in. [±0,5 mm] unless otherwise noted

Ordering Information:

Model Number:

RT9420- _____ **1** - **1** _____ **0**
order code: R A B C D E F G

Sample Model Number:

RT9420 - 0005 - 111 - 1110

- R range: 5 turns (clockwise shaft rotations)
- A enclosure: aluminum
- B shaft diameter: .25 inches
- E output signal: 4...20 mA signal increasing clockwise
- F electrical connection: 6-pin plastic connector

Full Stroke Range:





R order code:	R125	0R25	0R50	0001	0002	0003	0005	0010	0020	0030	0050
clockwise shaft rotations, min:	0.125	0.25	0.50	1	2	3	5	10	20	30	50
accuracy (% of f.s.):	0.3%	0.3%	0.3%	0.3%	0.3%	0.3%	0.2%	0.15%	0.15%	0.15%	0.15%
potentiometer cycle life*:	2.5 x 10 ⁶	2.5 x 10 ⁶	2.5 x 10 ⁶	2.5 x 10 ⁶	2.5 x 10 ⁶	2.5 x 10 ⁶	5 x 10 ⁵	2.5 x 10 ⁵	2.5 x 10 ⁵	2.5 x 10 ⁵	2.5 x 10 ⁵

*-number of times the sensor shaft can be cycled back and forth from beginning to end and back to the beginning before any measurable signal degradation may occur.

Enclosure Material:

A order code:	1	2
	powder-painted aluminum	303 stainless steel

Shaft Diameter:

B order code:	1	2	3	4
	0.25-in. diameter	6 mm diameter	0.25-in. dia. w/flats	6 mm dia. w/flats
				
	.2497 in. (+.0000 -0.0003)	5.995 mm (+.000 -0.025)	0.33 in. 0.025 in.	8.4 mm 0.64 mm

Ordering Information (cont.):

Output Signals:

order code:	1	2	3	4	5*	6*
output signal options:	4...20 mA 	20...4 mA 	0...20 mA 	20...0 mA 	4...20 mA 	20...4 mA
sensitivity:	16 mA/full stroke $\pm 0.25\%$		20 mA/full stroke $\pm 0.25\%$		16 mA/full stroke $\pm 0.25\%$	
wiring configuration:	2 - wire		3 - wire		2 - wire	
input voltage:	8 - 34 vdc		14 - 29 vdc		14 - 32 vdc	
hazardous area certification:	not certified				CSA • Cenelec	

Example:

ordercode = 1 = 4...20 mA

max ccw = 4 mA

max cw = 20 mA

Hazardous Area Certifications:

CSA Standard 22.2 Class 1 Groups A, B, C and D

Cenelec LCIE EEx ia IIC T4

***IMPORTANT:** intrinsically safe when powered from a CSA certified zener barrier rated 28 VDC max, 110 mA max per installation drawing#677984

Electrical Connection:

order code:	1	2	3	4
	6-pin plastic connector w/mating plug IP 67, NEMA 4X** ,6	10-ft. [3 M] waterproof cable IP 67, NEMA 4X** , 6	6-pin metal connector w/mating plug IP 65, NEMA 4	25-ft. [7.5 M] instrumentation cable IP 67, NEMA 6
	 3.0 in. [78 mm]		 2.4 in. [60 mm]	
	1/2 - 5/16" [14 - 8 mm] cable dia. 16 AWG max conductor size connector: MS3102E-14S-6P mating plug: MS3106E-14S-6S	10 ft. x 0.4-in. dia. [3 M x 10 mm dia.] 18 AWG, type SJTW	3/8-in. [9 mm] max cable dia. 16 AWG max conductor size connector: MS3102E-14S-6P mating plug: MS3106E-14S-6S	25 ft. x 0.2-in. dia. [7,5 M x 5 mm dia.] 24 AWG, shielded

order code:	5	6	7
	100-ft. [30 M] waterproof cable IP 67, NEMA 4X** ,6	10-ft. [3 M] pressure tested* waterproof cable IP 68, NEMA 4X** , 6P	100-ft. [30 M] pressure tested* waterproof cable IP 68, NEMA 4X** , 6P
	100 ft. x 0.4-in. dia. [30 M x 10 mm dia.] 18 AWG, type SJTW	10 ft. x 0.4-in. dia. [3 M x 10 mm dia.] 18 AWG, type SJTW	100 ft. x 0.4-in. dia. [30 M x 10 mm dia.] 18 AWG, type SJTW

6-pin Mating Plug		Waterproof Cable		Instrumentation Cable		
pin	2-wire	2-wire	3-wire	color code	2-wire	3-wire
A	8...34 vdc***	8...34 vdc***	14...29 vdc common	WHITE	8...34 vdc***	14...29 vdc common
B	4...20 mA out	4...20 mA out	14...29 vdc common	BLACK	4...20 mA out	n/a
C	-	-	0...20 mA out	GREEN	n/a	n/a
D	case ground	case ground	0...20 mA out		case ground	0...20 mA out

contact view

Notes: { * -Test pressure: 100 feet [30 meters] H₂O (40 PSID); Test Medium: Air; Duration: 2 hours.
** -NEMA 4X applies to stainless steel enclosure only.
*** -14-32 VDC for hazardous area option.

Output Signal Selection:

The output signal direction can be reversed at any time by simply changing the dip-switch settings found on the internal signal board. After the settings have been changed, adjustment of the Zero and Span trimpots will be required to precisely match signal values to the beginning and end points of the stroke.

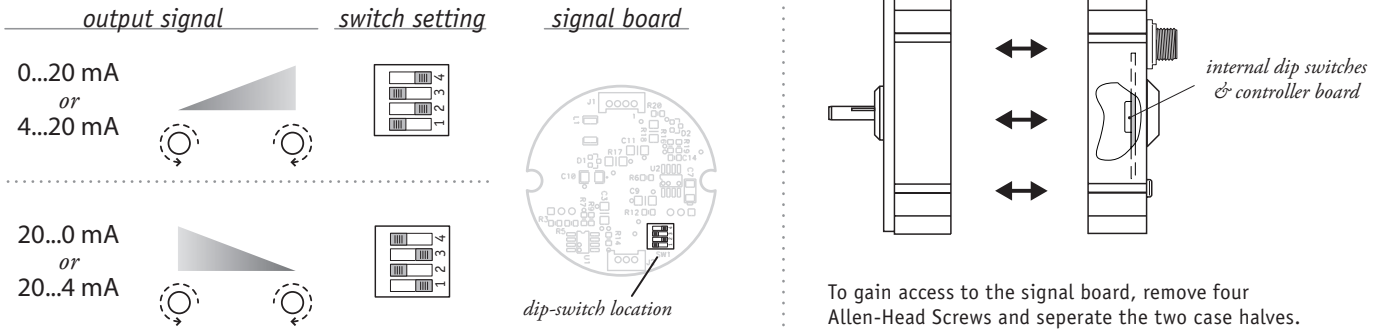

version: 7.0 last updated: March 1, 2014