

GNB



ACTUADORES NEUMÁTICOS ROTATIVOS
RACK & PINION ACTUATORS

SÉRIE GNP / GNP SERIE

CARACTERÍSTICAS / FEATURES

Cuerpo de aluminio extruido según ASTM 6005, con anodizado duro como protección a la corrosión interna y externa, con fino acabado interno del cilindro para obtener un bajo coeficiente de fricción, y posteriormente pintado externo con pintura de poliéster en polvo color azul.

El diseño compacto de piñón y cremallera doble permite un ensamblaje simétrico, un largo ciclo de vida, así como una rotación en sentido inverso (en este caso tan solo hay que realizar una simple inversión de los pistones).

Rotación Standard:
sentido anti-horario abre / sentido horario cierra.

Múltiples guías y bujes en cremallera y pistones que reducen la fricción, con largo ciclo de vida y diseño anti-expulsión del eje.

Diseño modular del cartucho con resorte precargado y revestido para mayor versatilidad, mayor seguridad y mayor resistencia a la corrosión.

Dientes completamente mecanizados en pistón y en piñón para una máxima eficacia y un mínimo contragolpe entre piñón y cremallera.

Fijadores en acero inoxidable para una mayor resistencia a la corrosión.

Conformidad completa con las últimas especificaciones: ISO5211, DIN 3337 y NAMUR confiriendo una gran capacidad de adaptación y fácil montaje de electroválvulas, finales de carrera y otros accesorios.

Homologación ATEX según directiva 94/9/CE para atmósferas explosivas : Categoría II 2 GD T5 (Zonas 1,2 / 21,22).

Condiciones de operación:

1. Fluidos de accionamiento

Aire seco o lubricado, Gases no corrosivos, o aceite.

2. Presión de suministro de aire

Doble acción: 2-8 Bar;
Simple acción: 2-8 Bar

3. Temperatura de funcionamiento

Standard: de -20°C +80°C
Baja temperatura: de -35°C +80°C
Alta temperatura: -15°C +150°C

4. Recorrido del ajuste

Tiene un rango de ajuste de $\pm 5^\circ$ para la rotación en 90°

5. Lubricación

No necesita acrecentar el lubricante en condiciones normales de trabajo

6. Aplicación

Cualquiera interior o exterior

7. Presión máxima

La presión máxima de entrada debe ser de 8 Bar.

Extruded aluminium ASTM6005 body with internal surface having honed cylinder for longer life and low friction coefficient, and both internal and external corrosion protection treated with hard anodized and the external blue powder polyester painted.

Dual piston rack and pinion design for compact construction, symmetric mounting position, high-cycle life and fast operation, reverse rotation can be accomplished in the field by simply inverting the pistons.

Standard Rotation:
Counter Clock Wise open / Clock Wise close.

Multiple bearings and guides on racks and pistons, low friction, high cycle life and prevent shaft blow out.

Modular preloaded spring cartridge design, with coated spring for simple versatile range, greater safety and corrosion resistance, longer cycle life.

Fully machined teeth on piston and pinion for accurate low backlash rack and pinion engagement, maximum efficiency.

Stainless steel fasteners for long term corrosion resistance

Full conformance to the latest specifications: ISO5211, DIN 3337 and NAMUR or product interchange ability and easy mounting of solenoids, limit switches and other accessories.

ATEX certification according to 94/9/CE for explosive atmospheres: Class II 2 GD T5 (Zones 1,2 / 21,22).

Operating Conditions:

1. Operating media

Dry or lubricated air, the non-corrosive gases or oil.

2. Air supply pressure

Double acting: 2-8 Bar;
Spring return: 2-8 Bar

3. Operating temperature

Standard: -20°C+80°C
Low temperature: -35°C+80°C
High temperature: -15°C+150°C

4. Travel adjustment

Have adjustment range of $\pm 5^\circ$ for the rotation at 90°

5. Lubrication

Under normal operating condition, need not accrete lubricant

6. Application

Either indoor or outdoor

7. Highest pressure

The maximum input pressure is 8 Bar

Doble efecto / Double acting

Rotación estándar / Standard rotation

Rotación invertida / Reverse rotation

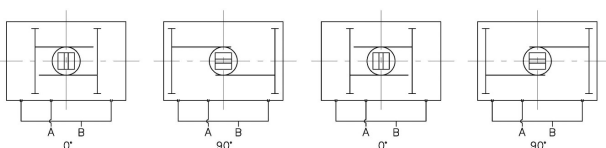

Simple efecto / Spring return

Rotación estándar / Standard rotation

Rotación invertida / Reverse rotation

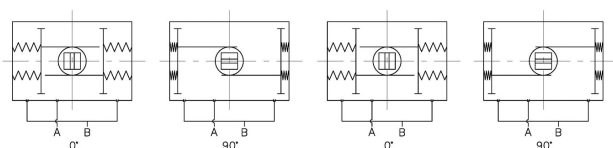

DESPIECE / PARTS

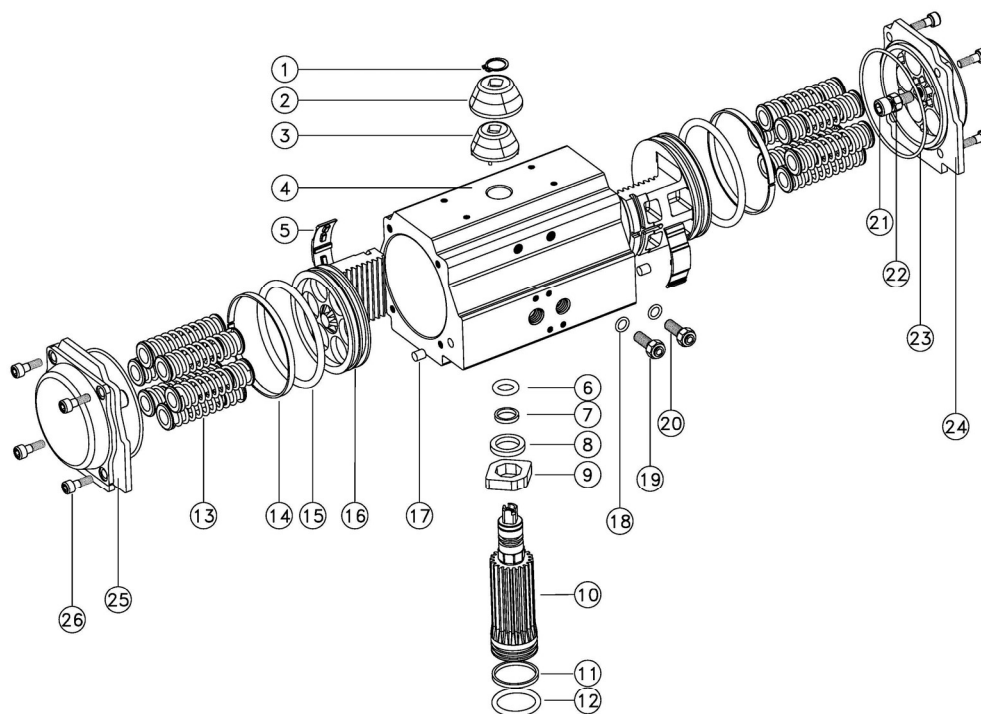

Nº	Denominación / Name	Cantidad / Quantity	Material / Material	Protección / Protection
1	Anillo Seeger / Spring clip	1	AISI 304 / Stainless Steel	
2	Carcasa indicador / Housing indicator	1	PC+ABS / Plastic	
3	Indicador / Indicator	1	PC+ABS / Plastic	
4	Cuerpo / Body	1	Al 6005-T5 / Extruded aluminium alloy	Anodizado + Pintado / Anodized + Painted
5	Guía Pistón / Guide piston	2	Tecnopolímero / Engineering plastics	
6	Tórica superior / O-ring (pinion top)	1	NBR / NBR	
7	Anillo superior / Washer (pinion top)	1	Tecnopolímero / Engineering plastics	
8	Separador / Bearing (pinion top)	1	Tecnopolímero / Engineering plastics	
9	Leva / Cam	1	Al. Acero / Alloy steel	
10	Piñón / Pinion	1	Al. Acero / Alloy steel	Niquelado / Nickel plated
11	Anillo inferior / Bearing (pinion bottom)	1	Tecnopolímero / Engineering plastics	
12	Tórica inferior / O-ring (pinion bottom)	1	NBR / NBR	
13	Muelle / Spring	0-12	AISI 301 / Stainless Steel	
14	Anillo pistón / Ring (Piston)	2	Tecnopolímero / Engineering plastics	
15	Tórica pistón / O-ring (Piston)	2	NBR / NBR	
16	Pistón / Piston	2	Al. A380.1 / Cast aluminium	Anodizado + Galvanizado / Anodized + Galvanized
17	Tapón / Hole sealant	2	NBR / NBR	
18	O-ring / O-ring	2	NBR / NBR	
19	Tuerca / Adjust Nut	2	AISI 304 / Stainless Steel	
20	Prisionero / Adjust screw	2	AISI 304 / Stainless Steel	
21	Tornillo tope / Stop screw	2	AISI 304 / Stainless Steel	
22	Tuerca tope / Nut (stop screw)	2	AISI 304 / Stainless Steel	
23	Tórica tapa / O-ring (End cap)	2	NBR / NBR	
24	Tapa derecha / End cap right	2	Al. A380.1 / Cast aluminium	Anodizado + Pintado / Anodized + Painted
25	Tapa izquierda / End cap left	2	Al. A380.1 / Cast aluminium	Anodizado + Pintado / Anodized + Painted
26	Tornillo tapa / Cap screw	8	AISI 304 / Stainless Steel	

DIMENSIONADO DOBLE EFECTO DOUBLE ACTING SIZING

El factor de seguridad sugerido para los actuadores de Doble Efecto bajo condiciones de trabajo normales es del 20% al 30%.

Ejemplo:

- El Par necesario para la válvula es de = 100 Nm
- El Par considerando el factor de seguridad (1+30%) es de 130 Nm
- Presión del aire de alimentación = 5 Bar

De acuerdo con la Tabla de Pares, nosotros debemos elegir el modelo más aproximado que es el **GNP 198**.

The suggested safety factor for Double Acting actuators under normal working conditions is 20%-30%.

Example:

- *The torque needed by valve=100Nm*
- *The torque considered safety factor (1+30%)=130 Nm*
- *Air Supply = 5 Bar*

*According to the above Torque Table, we can choose the minimum model is: **GNP 198**.*

DIMENSIONADO SIMPLE EFECTO SPRING RETURN SIZING

El factor de seguridad sugerido para los actuadores de Simple Efecto bajo condiciones de trabajo normales es del 30% al 50%.

Ejemplo:

- El Par necesario para la válvula = 100 Nm
- El Par considerando el factor de seguridad (1+30%) es de 130 Nm
- Presión del aire de alimentación = 5 bar

De acuerdo con la Tabla de Pares que nos dan los actuadores de Simple Efecto, encontramos que los valores de pares del modelo **GNP 513 S4 (4+4)** son:

Ejercido por aire a 0° = 291 Nm
Ejercido por aire a 90° = 221 Nm
Ejercido por muelles a 90° = 206 Nm
Ejercido por muelles a 0° = 137 Nm

Todos los pares obtenidos son superiores al necesitado por la válvula.

The suggested safety factor for spring return actuator under normal working conditions is 30-50%

Example:

- *The torque needed by valve = 80 Nm*
- *The torque consider safety factor (1+30%) =104 Nm*
- *Air Supply = 5 bar*

*According to the table of spring return actuators' output, we find output torque of **GNP 513 S4 (4+ 4)** is:*

*Air stroke 0°= 291 Nm
Air stroke 90°= 221 Nm
Spring stroke 90°=206 Nm
Spring stroke 0°=137 Nm*

All the output torque is larger than we needed.

PARES ACTUADORES DOBLE EFECTO DOUBLE ACTING ACTUATORS TORQUES

Modelo / Model	Presión alimentación de aire (Unidad Bar) / Air supply pressure (Unit Bar)									
	2	2.5	3	4	4.5	5	5.5	6	7	8
GNP 14	4.8	6.0	7.2	9.5	10.7	11.9	13.1	14.3	16.7	19.1
GNP 24	8.0	10.0	12.0	16.0	18.0	20.0	21.9	23.9	27.9	31.9
GNP 44	14.6	18.2	21.9	29.2	32.8	36.5	40.1	43.8	51.1	58.4
GNP 60	20.1	25.1	30.1	40.1	45.1	50.2	55.2	60.2	70.2	80.3
GNP 94	31.4	39.2	47.0	62.7	70.5	78.4	86.2	94.1	109.7	125.4
GNP 135	45.1	56.4	67.7	90.3	101.6	112.9	124.1	135.4	158.0	180.6
GNP 198	66.1	82.7	99.2	132.2	148.8	165.3	181.8	198.4	231.4	264.5
GNP 300	100.3	125.4	150.5	200.6	225.7	250.8	275.9	301.0	351.1	401.3
GNP 513	171.0	213.8	256.5	342.0	384.8	427.5	470.3	513.0	598.5	684.0
GNP 800	266.0	332.5	399.0	532.0	598.5	665.0	731.5	798.0	931.0	1064.0
GNP 1280	425.6	532.0	638.4	851.2	957.6	1064.0	1170.4	1276.8	1489.6	1702.4
GNP 1600	532.0	665.0	798.0	1064.0	1197.0	1330.0	1463.0	1596.0	1862.0	2128.0
GNP 2300	769.5	961.9	1154.3	1539.0	1731.4	1923.8	2116.1	2308.5	2693.3	3078.0
GNP 2500	1169.6	1462.1	1754.5	2339.3	2631.7	2924.1	3216.5	3508.9	4093.7	4678.6

PARES ACTUADORES SIMPLE EFECTO
SPRING RETURN ACTUATORS TORQUES

Tipo / Type	Cantidad de muelles / Spring Qty	Presión de aire de entrada en Bar / Air supply in Bar														Obtenido por muelle / Spring output		
		2,5		3		4		5		6		7		8		90°	0°	
		0°	90°	0°	90°	0°	90°	0°	90°	0°	90°	0°	90°	0°	90°			
GNP 24S	3 + 2	5.7	3.8	7.6	5.7												6.2	4.3
	3 + 3	4.9	2.5	6.9	4.5	10.9	8.5										7.4	5.0
	4 + 3	4.0	1.3	6.0	3.3	9.8	7.3	14.0	10.4								8.6	5.9
	4 + 4			5.2	2.0	9.2	6.0	13.2	9.1	17.2	14.1						9.9	6.7
	5 + 4			4.3	0.8	8.3	4.8	12.3	7.9	16.3	12.8	20.3	16.8				11.1	7.6
	5 + 5					7.4	3.6	11.5	6.7	15.5	11.6	19.5	15.6				12.4	8.5
	6 + 5					6.6	2.3	10.6	5.4	14.6	10.4	18.6	14.3	22.6	18.3		13.6	9.3
	6 + 6							9.7	4.2	13.8	9.1	17.8	12.2	21.8	17.1		14.8	10.2
GNP 44S	3 + 2	11.4	7.7	15.0	11.4	22.3	14.9										10.4	6.8
	3 + 3	10.1	5.7	13.6	9.3	20.9	16.6	28.3	23.9								12.5	8.2
	4 + 3	8.6	3.6	12.5	7.2	19.5	14.5	26.8	21.9								14.6	9.6
	4 + 4			10.9	5.1	18.2	12.4	25.5	19.8	32.8	27.0	40.1	34.3				16.7	10.9
	5 + 4					16.8	10.4	24.1	17.7	31.4	24.9	38.7	32.3				18.8	12.3
	5 + 5					1.4	8.2	22.8	15.6	30.0	22.8	37.3	30.1	44.7	37.4		20.9	13.7
	6 + 5							21.5	13.5	28.7	20.7	36.0	28.0	43.3	35.3		22.9	15.0
	6 + 6							20.0	11.4	27.3	18.6	34.6	25.9	41.9	33.3		25.0	16.4
GNP 60S	3 + 2	14.5	10.6	19.4	15.5	29.5	25.7										14.5	10.5
	3 + 3	12.4	7.6	17.3	12.6	27.4	22.7	37.5	32.8								17.4	12.7
	4 + 3	10.4	4.8	15.2	9.7	25.3	19.6	35.4	29.9								20.3	14.8
	4 + 4			13.1	6.8	23.1	16.9	33.3	27.0	43.2	37.0	53.3	47.0				23.2	16.9
	5 + 4					21.0	14.1	31.2	24.1	41.1	34.1	51.2	44.2				26.1	19.0
	5 + 5					19.0	11.1	28.8	21.2	39.0	31.2	49.1	41.2	59.1	51.2		29.0	21.1
	6 + 5							27.0	8.3	37.0	28.3	47.0	38.4	57.0	48.4		31.9	23.2
	6 + 6							24.9	15.4	34.9	25.4	44.9	35.4	54.9	45.4		34.7	25.3
GNP 94S	3 + 2	23.3	16.1	31.1	24.0	46.8	39.7										23.0	15.8
	3 + 3	20.1	11.5	28.0	19.3	43.7	35.1	59.4	50.7								27.6	19.0
	4 + 3	17.0	6.9	24.8	14.8	40.5	30.5	56.2	46.2								32.2	22.1
	4 + 4			21.7	10.1	37.4	25.8	53.1	41.5	68.8	57.2	84.5	72.9				36.8	25.3
	5 + 4					34.2	21.3	49.9	37.0	65.6	52.6	81.2	68.3				41.4	28.5
	5 + 5					31.0	16.6	46.7	32.3	62.4	48.0	78.1	63.7	93.8	79.3		46.0	31.6
	6 + 5							43.6	27.7	59.3	43.4	75.0	59.1	90.6	74.8		50.6	34.8
	6 + 6							40.4	23.2	56.1	38.9	71.7	54.5	87.4	70.2		55.2	38.0
GNP 135S	3 + 2	33.1	22.0	44.2	33.2	66.8	55.9										34.4	23.3
	3 + 3	28.4	15.2	39.6	26.4	62.2	49.0	84.4	71.6								41.2	28.0
	4 + 3	23.8	8.2	34.9	19.4	57.5	42.1	80.2	64.7								48.1	32.7
	4 + 4			31.3	12.6	52.9	35.2	75.5	57.9	98.1	80.5	120.7	103.0				55.0	37.3
	5 + 4					48.2	28.4	70.9	51.0	93.5	73.6	116.0	96.1				61.9	42.0
	5 + 5					43.6	21.5	66.2	44.1	88.8	66.7	111.3	89.2	134.0	111.8		68.7	46.7
	6 + 5							61.5	37.2	84.1	59.9	106.6	82.4	129.2	105.0		75.6	51.4
	6 + 6							56.8	30.4	79.4	53.0	101.9	75.5	124.5	98.1		82.5	56.0
GNP 198S	3 + 2	51.0	33.4	67.5	49.9	100.6	83.0										49.2	31.6
	3 + 3	44.7	23.5	61.1	40.0	94.2	73.2	127.3	106.2								59.1	38.0
	4 + 3	38.4	13.7	54.9	30.3	87.9	63.4	121.0	96.4								68.9	44.3
	4 + 4			48.5	20.4	81.6	53.5	114.7	86.5	147.7	119.6	180.8	152.7				78.7	50.6
	5 + 4					75.3	43.7	108.4	76.8	141.5	109.8	174.5	142.9				88.6	56.9
	5 + 5					68.9	33.4	102.0	66.5	136.1	99.6	168.2	132.6	201.2	165.7		98.4	63.3
	6 + 5							95.7	57.0	128.7	90.1	161.8	123.1	194.8	156.2		108.3	69.6
	6 + 6							89.4	47.5	122.5	80.6	155.5	113.6	188.6	146.7		118.1	75.9
GNP 300S	3 + 2	73	47	98	72	148	122										79	52
	3 + 3	63	31	88	56	138	107	188	157								94	6
	4 + 3	52	15	77	40	127	90	178	141								110	73
	4 + 4			67	25	117	75	167	125	217	176	268	226				125	84
	5 + 4					107	59	157	109	207	159	257	210				141	94
	5 + 5					96	44	146	94	196	144	247	194	297	245		157	105
	6 + 5							136	78	186	128	236	178	286	228		173	115
	6 + 6							125	63	176	113	226	163	276	213		188	125
GNP 513S	3 + 2	128	85	171	127	256	213										129	86
	3 + 3	111	59	154	102	239	187	325	273								155	103
	4 + 3	94	33	137	76	222	162	308	247								181	120
	4 + 4			120	50	205	136	291	221	376	307	462	392				206	137
	5 + 4					187	110	273	196	358	281	444	367				232	155
	5 + 5					170	84	256	169	341	255	427	340	512	426		258	172
	6 + 5							238	143	324	229	409	314	495	400		284	189
	6 + 6							221	118	307	203	392	289	478	374		310	206
GNP 800S	3 + 2	193	124	259	191	392	324										208	140
	3 + 3	165	83	232	149	365	282	498	415								250	168
	4 + 3	137	41	203	107	336	240	469	373								292	196
	4 + 4			176	66	309	199	442	237	575	465	708	598				333	223
	5 + 4					280	157	413	290	546	423	679	556				375	251
	5 + 5					253	115	386	248	519	381	652	514	785	647		417	279
	6 + 5							358	207	491	340	624	473	757	606		458	307
	6 + 6							330	165	463	298	596	431	729	564		500	335

Tipo / Type	Cantidad de muelles / Spring Qty	Presión de aire de entrada en Bar / Air supply in Bar														Obtenido por muelle / Spring output		
		2,5		3		4		5		6		7		8		90°		
		0°	90°	0°	90°	0°	90°	0°	90°	0°	90°	0°	90°	0°	90°	90°	0°	
GNP 1280S	3 + 2	332	222	438	329	651	542										309	200
	3 + 3	292	161	398	267	611	480	824	693								371	240
	4 + 3	252	99	358	205	571	418	784	631								433	280
	4 + 4			318	143	531	356	744	569	957	782	1169	995				495	320
	5 + 4					491	295	704	507	917	720	1130	933				557	360
	5 + 5					451	233	664	446	877	658	1090	871	1302	1084		618	400
	6 + 5							624	384	837	597	1050	809	1263	1022		680	440
	6 + 6							584	322	797	535	1010	748	1223	960		742	480
GNP 1600S	3 + 2	390	285	52	418	789	684										380	275
	3 + 3	335	209	468	342	734	608	1000	874								456	330
	4 + 3	280	133	413	266	679	532	945	798								532	385
	4 + 4			358	190	624	456	890	722	1156	988	1422	1254				608	440
	5 + 4					569	380	835	646	1101	912	1367	1178				684	495
	5 + 5					514	304	780	570	1046	836	1312	1102	1578	1368		760	550
	6 + 5							725	494	991	760	1257	1026	1523	1292		836	605
	6 + 6							670	418	936	684	1202	950	1468	1216		912	660
GNP 2300S	3 + 2	552	409	744	600	1129	985										554	410
	3 + 3	470	297	662	489	1047	874	1432	1259								665	492
	4 + 3	388	187	580	379	964	764	1349	1149								775	575
	4 + 4			498	268	883	653	1267	1037	1652	1422	2037	1807				886	656
	5 + 4					800	542	1185	926	1569	1311	1954	1696				998	739
	5 + 5					718	431	1103	816	1488	1201	1872	1586	2257	1970		1108	821
	6 + 5							1021	705	1408	1090	1791	1474	2176	1859		1219	903
	6 + 6							939	594	1323	979	1708	1363	2093	1748		1330	985
GNP 2500S	3 + 2	903	675	1195	968	1779	1552										787	560
	3 + 3	790	519	1083	811	1667	1396	2252	1981								943	672
	4 + 3	679	361	972	654	1556	1238	2141	1823								1101	783
	4 + 4			860	497	1444	1081	2029	1666	2614	2252	3199	2836				1258	895
	5 + 4					1332	923	1917	1509	2502	2094	3087	2678				1416	1007
	5 + 5					1220	767	1806	1352	2390	1937	2974	2521	3560	3107		1572	119
	6 + 5							1693	1194	2278	1779	2862	2364	3448	2949		1730	1231
	6 + 6							1582	1037	2167	1623	2751	2207	3336	2792		1887	1342

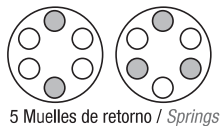

5 Muelles de retorno / Springs

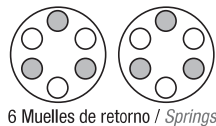

6 Muelles de retorno / Springs

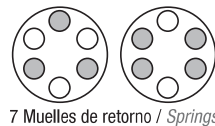

7 Muelles de retorno / Springs

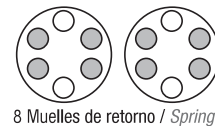

8 Muelles de retorno / Springs

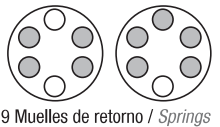

9 Muelles de retorno / Springs

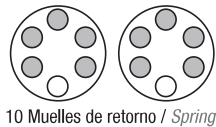

10 Muelles de retorno / Springs

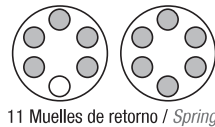

11 Muelles de retorno / Springs

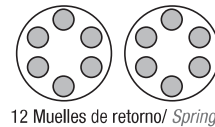

12 Muelles de retorno / Springs

CONSUMO DE AIRE AIR CONSUMPTION

Modelo / Model	Volumen abriendo/ Volume opening	Volumen cerrando/ Volume closing
GNP 14	0.08	0.11
GNP 24	0.12	0.16
GNP 44	0.21	0.16
GNP 60	0.30	0.34
GNP 94	0.43	0.47
GNP 135	0.64	0.73
GNP 198	0.95	0.88

Modelo / Model	Volumen abriendo/ Volume opening	Volumen cerrando/ Volume closing
GNP 300	1.60	1.40
GNP 513	2.5	2.2
GNP 800	3.7	3.2
GNP 1280	5.9	5.4
GNP 1600	7.5	7.5
GNP 2300	11.0	9.0
GNP 2500	17.0	14.0

El aire consumido depende de la presión, del volumen y del tiempo del ciclo y se calcula como sigue:

$I/min = \text{Volumen de aire (Volumen de aire Abriendo + Volumen de aire Cerrando)} \times [(\text{Presión de aire alimentación (Kpa)} + 101.3) / 101.3] \times \text{Tiempo duración del ciclo (/min)}$

Air consumption depends on Air Supply. Air volume and Action cycle times, the calculating as follows

$I/min = \text{Air volume (Air volume Opening + Air volume closing)} \times [(\text{Air Supply (Kpa)} + 101.3) / 101.3] \times \text{Action cycle times (/min)}$

Cuerpo / Body

Cuerpo de aluminio extruido según ASTM 6005 con recubrimiento de pintura poliéster.

Extruded aluminium ASTM6005 body with powder polyester painted.

Piñón / Pinion

El piñón es de alta precisión e integral fabricado en aleación de acero niquelado.

The pinion is high-precision and integrative made from nickelled-alloy steel.

Dispositivo tope / Stop Device

Dos tornillos externos permiten el ajuste en +/- 5° en la apertura y cierre.

The two independent external travel stop adjustment bolts can adjust +/- 5° at both open and close directions.

Tapas / End Caps

Fundición de aluminio con recubrimiento de pintura poliéster.

Die-casting aluminium powder polyester painted.

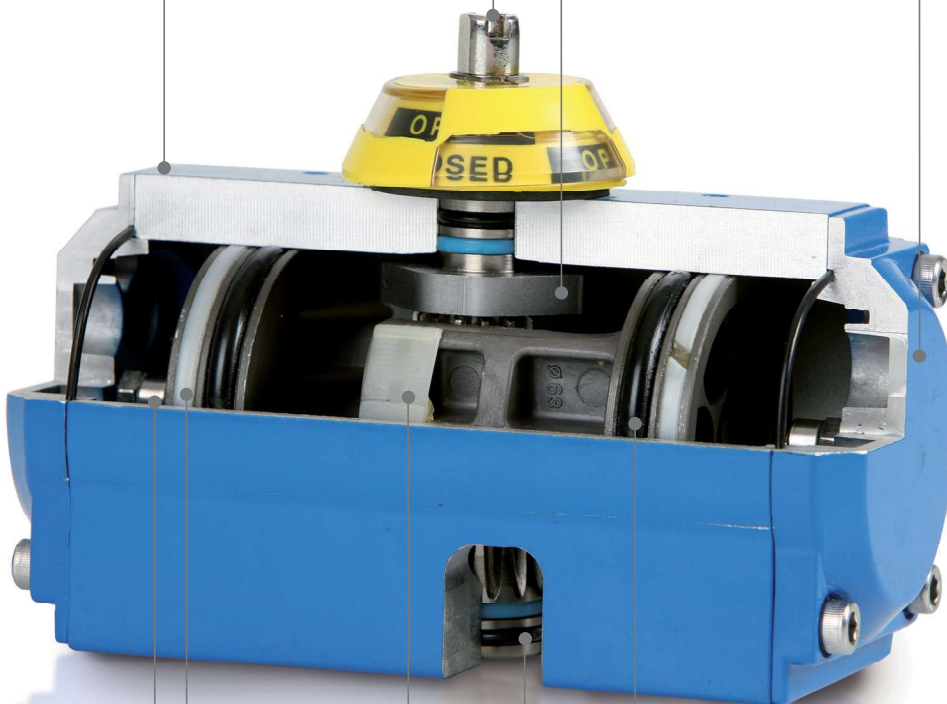

Pistones / Pistons

Fabricados en fundición de aluminio con posterior tratamiento de anodizado duro o fundición de acero galvanizado.

The pistons are made from Die-casting aluminium treated with Hard anodized or made from Cast steel with galvanization

Patines y Guías / Bearings & Guides

Fabricados en Tecno - polímero garantiza amplia area de contacto, elevada duración optimo deslizamiento.

Made from Techno - polymer, large contact area, high performance, long life resistance.

Tóricas / O'rings

Las tóricas en NBR proporcionan un trabajo seguro en rangos de temperatura normales.

NBR rubber o'rings provide trouble - free operation at standard temperature ranges



EDIFICIO GENEBRE. Av. de Joan Carles I , 46-48
08908 L'Hospitalet de Llobregat. Barcelona (Spain)
Nacional: Tel. +34 932 988 001. Fax. +34 932 988 006
Exportación: Tel. +34 932 988 000. Fax. +34 932 988 008
genebre@genebre.es - www.genebre.es
Servicio de Atención Técnica al Cliente: 902 504 203