

Hahn Part Number: Z10-28ST#06855
 Z 10 28 0350 0 0870 WG35 WG35 01200N /5/6/Si

Usable stroke less than nominal stroke

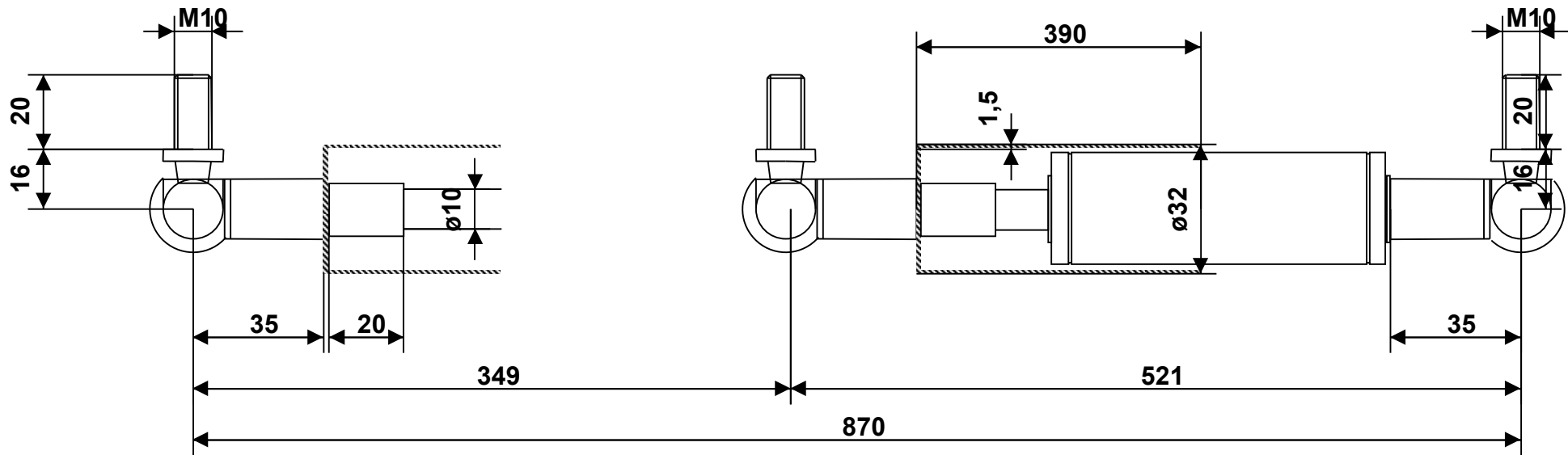

Intended for internal use and customer / Tolerance of ext. length: +/- 2mm - Dimensions without tolerance: per DIN ISO 2768-1 -c (ISO 2768 -c) - For Information Only
 Force tolerance: F1 >= 1000N: +/- 5%; < 1000N: +/- 10%, min.: +/- 10N, max.: +/- 50N - Unregistered Copy, Print-out or file not subject to modification service.
 End fitting orientation is random and not represented by drawing unless specified - Observe disposal instructions - Not true to scale



Please note our technical instructions

Assembly/storing with piston rod up

30. Mar 2020

Auto-Printservice

No opening-no heating-high pressure

Made in Germany

Part

Dimension

Material / Surface

Fitting

Progr.:27,80 %

Drawing owned by Hahn Gasfedern GmbH

Piston rod

Ø10mm

steel, chrome plated

WG35 M10 CS16 * ANS/M10/WIG/001

info@hahn-gasfedern.de

Cylinder

Ø28mm

Stahl,zinc plated

WG35 M10 CS16 * ANS/M10/WIG/001

www.hahn-gasfedern.de

Configuration ID : 10049964-