

TT Series Oil / Air Cooler

12V/24V DC, asa rail system

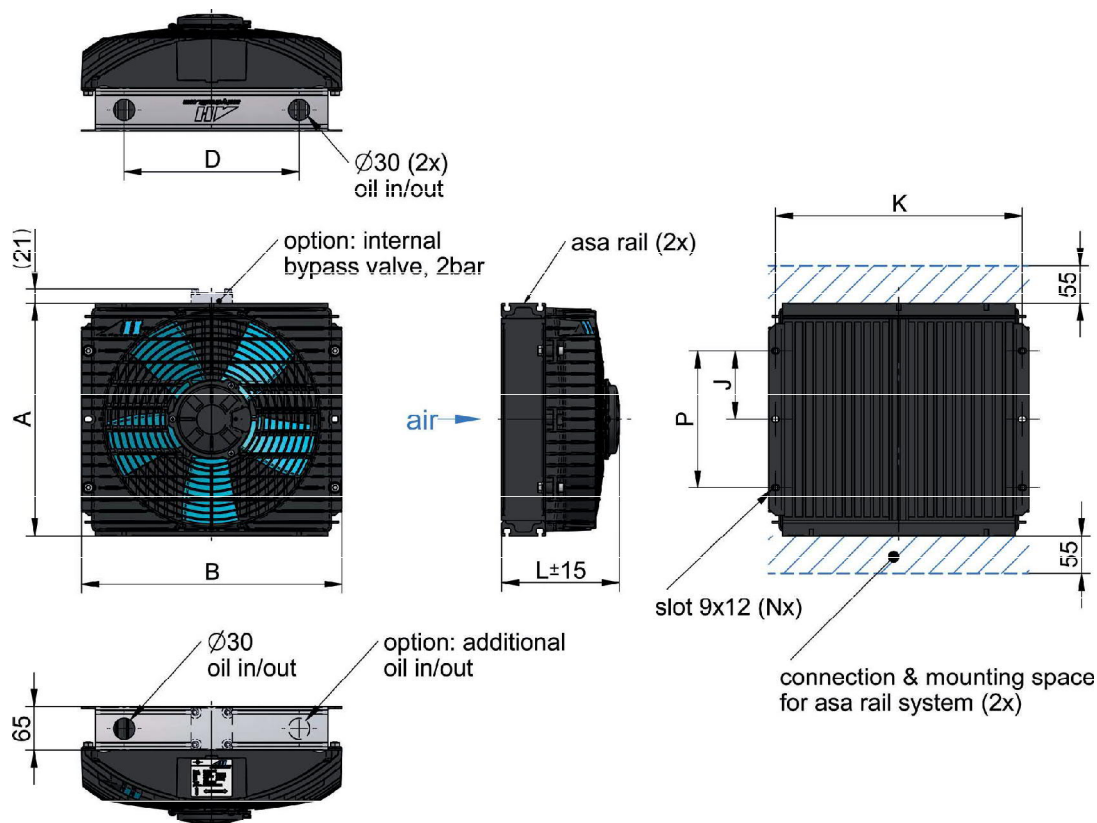

Dimensions

order number	description	A	B	D	J	P	K	L	N	weight
		[mm]	[mm]	[mm]	[mm]	[mm]	[mm]	[mm]		[kg]
ASATT05RD01	TT 05 rail 12V DC	235	245	118	-	150	225	150	4	4,3
ASATT05RD02	TT 05 rail 24V DC	235	245	118	-	150	225	150	4	4,3
ASATT07RD01	TT 07 rail 12V DC	300	320	176	-	172	290	160	4	6,5
ASATT07RD02	TT 07 rail 24V DC	300	320	176	-	172	290	160	4	6,5
ASATT07RD03	TT 07 rail 12V DC h.p.	300	320	176	-	172	290	176	4	7,0
ASATT07RD04	TT 07 rail 24V DC h.p.	300	320	176	-	172	290	176	4	7,0
ASATT11RD01	TT 11 rail 12V DC	340	380	255	100	200	360	175	6	9,2
ASATT11RD02	TT 11 rail 24V DC	340	380	255	100	200	360	175	6	9,2
ASATT13RD01	TT 13 rail 12V DC	420	410	255	-	233	386	200	4	12,0
ASATT13RD02	TT 13 rail 24V DC	420	410	255	-	233	386	200	4	12,0
ASATT16RD01	TT 16 rail 12V DC	465	460	328	153	306	436	190	6	14,9
ASATT16RD02	TT 16 rail 24V DC	465	460	328	153	306	436	190	6	14,9
ASATT21RD01	TT 21 rail 12V DC	605	462	328	208,5	417	436	243	6	19,4
ASATT21RD02	TT 21 rail 24V DC	605	462	328	208,5	417	436	243	6	19,4
ASATT21RD03	TT 21 rail 12V DC h.p.	605	462	328	208,5	417	436	261	6	20,4
ASATT21RD04	TT 21 rail 24V DC h.p.	605	462	328	208,5	417	436	261	6	20,4
ASATT25RD01	TT 25 rail 12V DC	605	555	421	208,5	417	530	266	6	22,7
ASATT25RD02	TT 25 rail 24V DC	605	555	421	208,5	417	530	266	6	22,7

Radiator Style B

material:	aluminum
working temperature range:	-20°C to +80°C (oil temperature)**
air fin shape:	wavy
working pressure:	26 bar (static)

Installation System (asa rail connectors)

connection BSP 1"	ILLZSET5G25 (1 set per cooler required)
connection BSP 1 1/4"	ILLZSET5G32 (1 set per cooler required)
connection BSP 1" straight	ILLZSET5G25A (1 set per cooler required)
connection BSP 1" straight+stnd.	ILLZSET5G25B (1 set per cooler required)

*...the indicated temperature is the maximum inlet temperature for the cooler radiator. Depending on the sealings in use, the application needs appropriate checking.

This data sheet and the corresponding scale drawings are to be used as a general guideline and technical overview of our products. Please contact us if more exact information is needed. As we are constantly improving our products, their characteristics, dimensions and weights may also change, although we do our best to incorporate these changes continually. asa assumes no liability for any information therein, any errors, omissions, misprints, nor any direct or indirect damages, losses or costs resulting therefrom. Any cooling performances and general technical values indicated in this catalogue are measured at a test bench according to asa testing procedures or calculated, based on such tests. Because there is no standardized testing procedure, tests used by other manufacturers could have different results. Due to different conditions in testing and application environments the cooling performance may also vary by +/- 15%. Therefore we recommend all products to be checked under the system operating conditions. This is also true of vibrations and mechanical stress as well as for pressure peaks and thermal stress and any other relevant factors. General tolerances according to DIN ISO 2768-v. General tolerances for casted parts according to EN ISO 8062-3 (DCTG 10). Tolerances for rubber parts are according to ISO 3302-1 (class M4-F+C). The tolerances of welding seams are defined by quality group D according to EN ISO 10042, if it is not specified on the actual scale drawing or data sheet. In addition to that we point out that any data sheet and corresponding scale drawing is no substitution for the manual.

TT Series Oil / Air Cooler

12V / 24V DC, asa rail system



Technical Data

order number	description	motor power [kW]	current [A]	protection	air flow [kg/s]	noise level [dB(A)]	optional internal bypass (2 bar) cooler order number
ASATT05RD01	TT 05 rail 12V DC	0,11	8,5	IP 68	0,19	74	on request
ASATT05RD02	TT 05 rail 24V DC	0,11	4,2	IP 68	0,19	74	on request
ASATT07RD01	TT 07 rail 12V DC	0,13	9,6	IP 68	0,32	74	ASATT07RD01BP
ASATT07RD02	TT 07 rail 24V DC	0,14	5,2	IP 68	0,32	74	ASATT07RD02BP
ASATT07RD03	TT 07 rail 12V DC h.p.	0,20	15,6	IP 68	0,40	78	ASATT07RD03BP
ASATT07RD04	TT 07 rail 24V DC h.p.	0,21	8,1	IP 68	0,40	78	ASATT07RD04BP
ASATT11RD01	TT 11 rail 12V DC	0,29	22,6	IP 68	0,57	77	ASATT11RD01BP
ASATT11RD02	TT 11 rail 24V DC	0,30	11,4	IP 68	0,57	77	ASATT11RD02BP
ASATT13RD01	TT 13 rail 12V DC	0,29	22,6	IP 68	0,65	77	ASATT13RD01BP
ASATT13RD02	TT 13 rail 24V DC	0,30	11,4	IP 68	0,65	77	ASATT13RD02BP
ASATT16RD01	TT 16 rail 12V DC	0,28	21,2	IP 68	0,75	79	ASATT16RD01BP
ASATT16RD02	TT 16 rail 24V DC	0,30	11,4	IP 68	0,75	79	ASATT16RD02BP
ASATT21RD01	TT 21 rail 12V DC	0,28	21,2	IP 68	0,82	78	ASATT21RD01BP
ASATT21RD02	TT 21 rail 24V DC	0,30	11,4	IP 68	0,82	78	ASATT21RD02BP
ASATT21RD03	TT 21 rail 12V DC h.p.	0,33	25,5	IP 68	1,02	81	ASATT21RD03BP
ASATT21RD04	TT 21 rail 24V DC h.p.	0,34	13,2	IP 68	1,02	81	ASATT21RD04BP
ASATT25RD01	TT 25 rail 12V DC	0,28	21,2	IP 68	0,88	78	ASATT25RD01BP
ASATT25RD02	TT 25 rail 24V DC	0,30	11,4	IP 68	0,88	78	ASATT25RD02BP

Performance

specific cooling performance

all products
water/glycol
compatibel

Contract us!

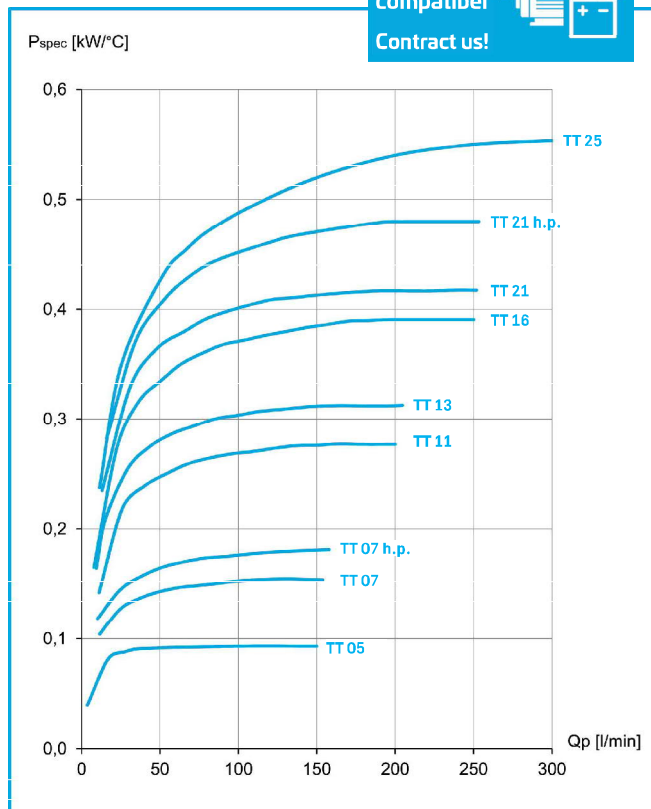

pressure drop at 30cSt

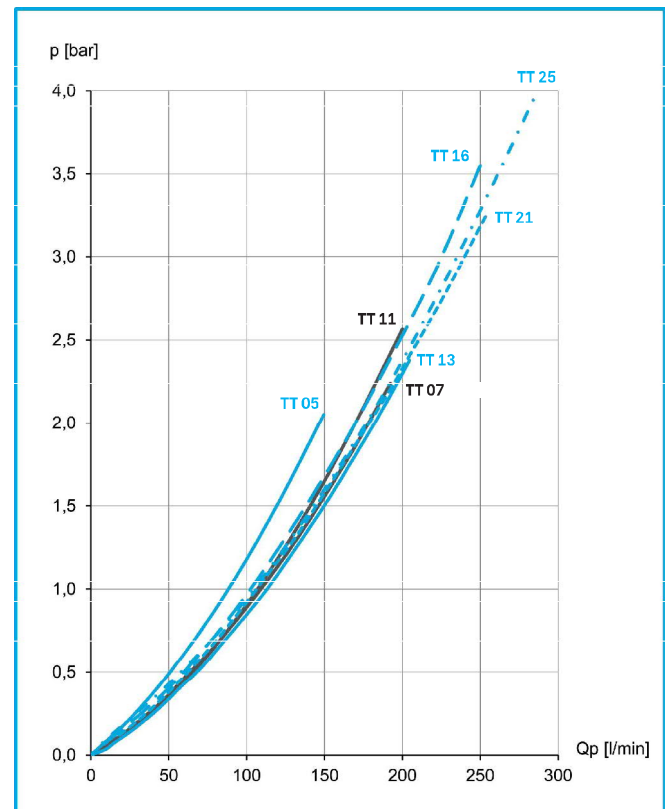

Options

temperature control	ILLZTC12-2K or 24-2K + ILLZTT5069K (page 37, 38)
temperature switches	ILLZTH5069K, ILLZTH4765K, ILLZTH6065K (page 39)
protection housings	available for sizes TT 07, 11 and 16
foot mounting	ILLEFUSSTTHDK (page 35)
internal bypass	alternative bypass settings (1bar / 5bar)

Please contact us for further options and assistance, read manual before installation!



This data sheet and the corresponding scale drawings are to be used as a general guideline and technical overview of our products. Please contact us if more exact information is needed. As we are constantly improving our products, their characteristics, dimensions and weights may also change, although we do our best to incorporate these changes continually. asa assumes no liability for any information therein, any errors, omissions, misprints, nor any direct or indirect damages, losses or costs resulting therefrom. Any cooling performances and general technical values indicated in this catalogue are measured at a test bench according to asa testing procedures or calculated, based on such tests. Because there is no standardized testing procedure, tests used by other manufacturers could have different results. Due to different conditions in testing and application environments the cooling performance may also vary by +/- 15%. Therefore we recommend all products to be checked under the system operating conditions. This is also true of vibrations and mechanical stress as well as for pressure peaks and thermal stress and any other relevant factors. General tolerances according to DIN ISO 2768-v. General tolerances for casted parts according to EN ISO 8062-3 (DCTG 10). Tolerances for rubber parts are according to ISO 3302-1 (class M4-F+C). The tolerances of welding seams are defined by quality group D according to EN ISO 10042, if it is not specified on the actual scale drawing or data sheet. In addition to that we point out that any data sheet and corresponding scale drawing is no substitution for the manual.

Accessories

Connector TT rail Series



Description

The asa rail system is the first worldwide flexible mounting and connection system for air blast heat exchangers. The flexibility comes from free choice of the port's direction. Each port on the radiator has 3 possibilities. This well designed radiator concept brings another flexibility innovation hit to the standard cooler market: The oil flow direction can be chosen between u-flow direction and diagonal oil flow on each TT rail cooler!

The radiator rail slots are not only for connecting the hydraulic ports, it is also possible to have the system attached with e.g.: bypass systems, mounting of the cooler to an aggregate, measurement devices, and much more. Please contact us to discover the huge potential of this rail system for your application.

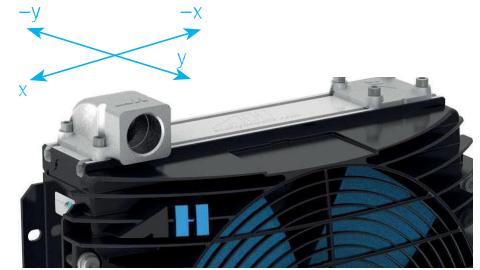

Dimensions

Ported connector

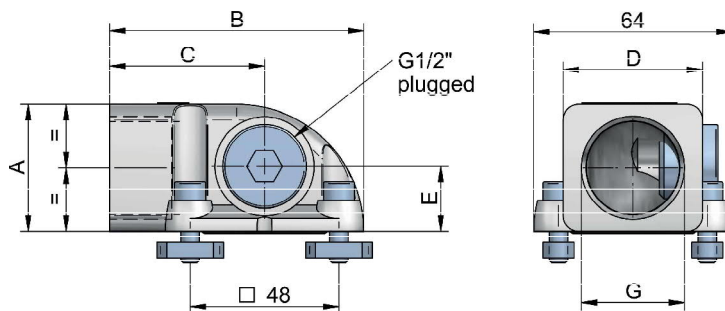

ported straight connector

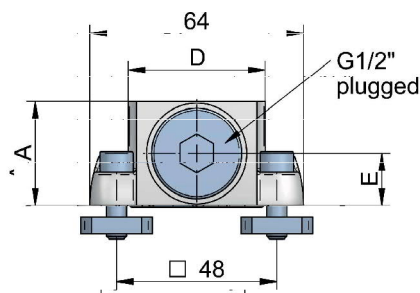

blind connector:

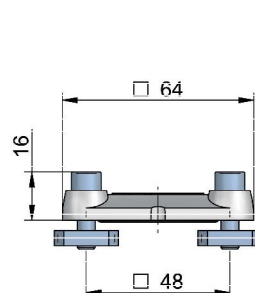

Technical Data

order number	description	o-ring	A	B	C	D	E	G	connection type	weight
			[mm]	[mm]	[mm]	[mm]	[mm]			[kg]
ILLZSET5G25	asa rail connector BSP 1"	NBR, 70 shore, 35 x 3mm	41	82	50	45	21	BSP 1"	2x 90°	0,90
ILLZSET5G32	asa rail connector BSP 1 1/4"		50	88	56	50	21	BSP 1 1/4"	2x 90°	1,05
ILLZSET5U16	asa rail connector UN 15/16"		41	82	50	45	21	UN 15/16"	2x 90°	0,90
ILLZSET5U20	asa rail connector UN 15/8"		50	88	56	50	21	UN 15/8"	2x 90°	1,10
ILLZSET5G25A	asa rail connector BSP 1" straight		31	-	-	41	15	BSP 1"	2x straight	0,66
ILLZSET5G25B	asa rail connector BSP 1" straight+Stnd.							BSP 1"	1x 90°, 1x straight	0,77

Content

ported connector with plugged G 1/2"	2x
blind connector	1x
o-ring	3x
slot nut	12x
screw M6x20	12x

requires 1 set per cooler

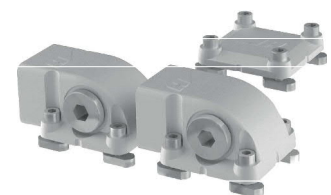

packed size: 1 set

Fits On Cooler Types

TT 05, 07, 11, 13, 16, 21, 25

This data sheet and the corresponding scale drawings are to be used as a general guideline and technical overview of our products. Please contact us if more exact information is needed. As we are constantly improving our products, their characteristics, dimensions and weights may also change, although we do our best to incorporate these changes continually. asa assumes no liability for any information therein, any errors, omissions, misprints, nor any direct or indirect damages, losses or costs resulting therefrom. Any cooling performances and general technical values indicated in this catalogue are measured at a test bench according to asa testing procedures or calculated, based on such tests. Because there is no standardized testing procedure, tests used by other manufacturers could have different results. Due to different conditions in testing and application environments the cooling performance may also vary by +/- 15%. Therefore we recommend all products to be checked under the system operating conditions. This is also true of vibrations and mechanical stress as well as for pressure peaks and thermal stress and any other relevant factors. General tolerances according to DIN ISO 2768-v. General tolerances for casted parts according to EN ISO 8062-3 (DCTG 10). Tolerances for rubber parts are according to ISO 3302-1 (class M4-F+C). The tolerances of welding seams are defined by quality group D according to EN ISO 10042, if it is not specified on the actual scale drawing or data sheet. In addition to that we point out that any data sheet and corresponding scale drawing is no substitution for the manual.