

Hahn Part Number: G06-15ST#14795
 G 06 15 0080 1 0235 WX22 WX22 40N

Usable stroke less than nominal stroke

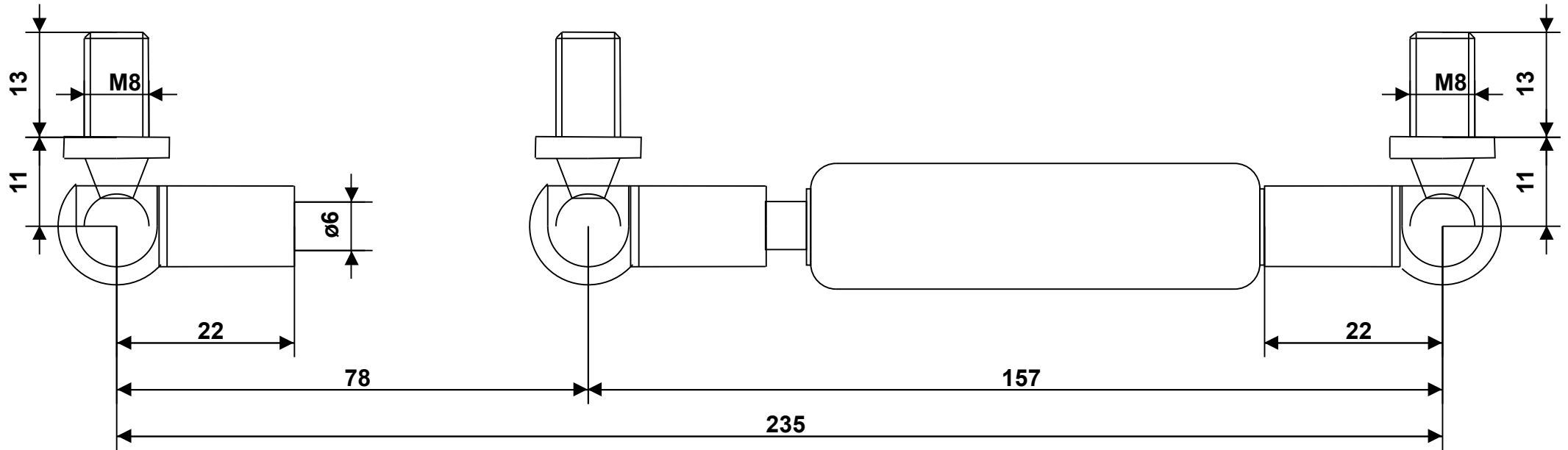

Intended for internal use and customer / Tolerance of ext. length: +/- 2mm - Dimensions without tolerance: per DIN ISO 2768-1 -c (ISO 2768 -c) - For Information Only
 Force tolerance: F1 >= 1000N: +/- 5%; < 1000N: +/- 10%, min.: +/- 10N, max.: +/- 50N - Unregistered Copy, Print-out or file not subject to modification service.
 End fitting orientation is random and not represented by drawing unless specified - Observe disposal instructions - Not true to scale



Please note our technical instructions

Assembly/storing with piston rod down

23. Mar 2021

Auto-Printservice

No opening-no heating-high pressure

Made in Germany

Part

Dimension

Material / Surface

Fitting

Progr.:35,90 %

Drawing owned by Hahn Gasfedern GmbH

Piston rod

Ø6mm

steel, chrome plated

WX22 M5/M8 CS10 * ANS/M05/WIG/004

info@hahn-gasfedern.de

Cylinder

Ø15,6mm

Stahl,black

WX22 M5/M8 CS10 * ANS/M05/WIG/004

www.hahn-gasfedern.de

Configuration ID : 10120106-