



SERIES

INSTANTANEOUS MONOSTABLE RELAYS

4-8-12 CONTACTS

APPLICATIONS



OKUIC

OVERVIEW

- Plug-in monostable instantaneous relays
- Solid and rugged construction for heavy or intensive duty
- Very high electrical life expectancy and exceptional endurance
- Patent operating mechanism, designed to ensure high contact pressure
- Ample clearance between open contact elements (from 1.2 to 4 mm)
- Independent and self-cleaning contacts with high breaking capacity
- Magnetic arc blow-out for higher breaking capacity
- Excellent shock and vibration resistance
- Wide variety of configurations and customizations
- Option for use in geothermal sites available
- Wide range of sockets
- Retaining clip for secure locking of relay on socket
- Transparent cover, pull-out handle
- Positive mechanical keying for relay and socket

DESCRIPTION

The OK series relays use a unique and **patented movement mechanism**, which reduces the friction to a minimum and achieves a **mechanical life of 100,000,000 operations**.

The peculiarity of the movement mechanism is given by an electromagnet which is vertically attracted towards the main airgap so as to fully exploit the generated magnetic flux.

While the stroke of the core is deliberately reduced to a minimum, **the movement of the contacts is amplified and thanks to a system of levers** capable of spacing the contacts up to over **4 mm**. This distance makes it possible to guarantee an impulse withstand voltage greater than **5 kV** between the poles of the same contact.

Each contact is mounted on individual and independent blades. These blades are designed to withstand **very high shocks** and ensure a pressure on the normally closed contacts equal to 1N and a shock resistance equal to 30g - 1ms of acceleration.

With high mechanical performance, follow excellent electrical performance that allows it to be used in the most critical applications in the rolling stock (railway) and energy transmission sectors.

The reliability granted by the relay's technical data is also proven by the numerous historical data and references collected from some of the most renowned Italian and international energy production authority.

The OK range consists of different variants, the main ones of which are:

- OKS I OK relay with the addition of a **powerful magnetic blow-out**, essential for the interruption of high DC loads.
- OKSFC I OK relay, sized for continuous operation applications.
- OKSCd I variant with cadmium-oxide contacts, necessary to manage important inrush currents up to 250 A.
- OKSGCCd I the OK relay with the highest breaking capacity, thanks to the NO contacts that reach a distance of 4mm.

STANDARD COMPLIANCE

EN 61810-3	EN 61810-1
EN 60077	EN 61810-7
EN 50155	EN 60695-2-10
EN 61373	EN 60529
EN 45545-2	EN 50082-2
ASTM E162, E662	



DESCRIPTION OF MODELS

Relays of the OK series are made in 7 models (OK, OKS, OKFC, OKSFC, OKSCD, OKSGcCd and OKUIC). The outputs are available on 16 terminals of standard dimensions 5x0.8mm, evenly and symmetrically divided into 4 rows spaced 10mm apart, in both directions. Internal connections are ordered symmetrically. Turning the relay through 180° on its connector has the effect simply of changing the contacts, without affecting operation (except in the case of relays with a polarized power input).

OK – OKS

The OK relay offers features of ruggedness, easy installation, high breaking capacity (with magnetic arc blow-out, model OKS), safe operation and adaptability to any kind of circuit, making it suitable for all heavy duty applications in the field of remote control systems and automation. The distance between contacts is 2.2mm. Superior shock and vibration resistance ensures that contacts are able to hold their operating position even when exposed to a shock force of 30g - 1ms. No opening of break contacts up to 3g. On the OKS model, a powerful magnetic arc blow-out located between the 4 change-over contacts has the effect of generating a permanent magnetic field. When an inductive load circuit is broken, the resulting arc is swiftly extended and finally extinguished through the action of the magnetic field created by the blow-out.

OKFC - OKSFC - OKUIC

The OKFC relay is an energy saving component. The distance between contacts is 1.2mm. Contact pressures and shock and vibration resistance are the same as specified for OK/OKS models. In the case of d.c. loads, the breaking capacity is reduced from that of the OK relay, although the addition of the magnetic arc blow-out (model OKSFC) provides breaking capacity of up to 15 A at 120Vdc (see example of electrical life expectancy).

On the OKSFC model, a powerful magnetic arc blow-out located between the 4 change-over contacts has the effect of generating a permanent magnetic field. When an inductive load circuit is broken, the resulting arc is swiftly extended and extinguished through the action of the magnetic field created by the blow-out. With direct current, breaking capacity is doubled. For d.c. and a.c. currents that can be broken without the blow-out, the effect of having this feature available will be to reduce wear on the contacts, doubling electrical life expectancy.

The connection of 2 contacts in series increases electrical life expectancy and doubles breaking capacity when handling direct current.

The connection of 2 contacts in parallel likewise increases electrical life expectancy.

In the event that the 4 contacts are all available for breaking purposes, it is possible to use a series/parallel connection arrangement as illustrated below.

In the case of high voltages, from 250V upwards, it is best to avoid breaking opposite polarities on adjacent contacts.

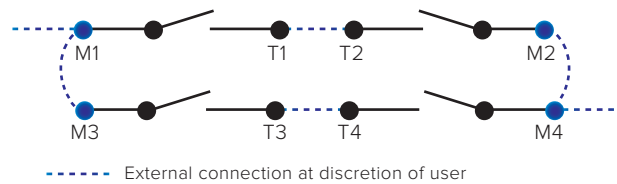

The use of the OKFC or OKSFC relay is advisable whenever the requirement is for detecting loss of voltage, hence where relays are permanently powered up, or when the ambient temperature may reach 70 °C. These relays can be powered up permanently, even at the maximum voltage of the specified operating range; they can also handle wide fluctuations in voltage and consequently are able to respond, for example, to standards for rolling stock, as in the case of the OKUIC model, which has a coil with a wide operating range.

OKSCD

The silver-coated contacts of normal relays can fuse together when closed if exposed to a peak current of 50 A for at least 5 ms. Using cadmium oxide contacts, the surfaces will fuse only at currents higher than 150 A. With magnetic arc blow-out fitted as standard to these relays, there is no possibility of the arc creating a hot spot between the contacts that could cause them to become welded together.

This relay is especially suitable for handling highly inductive direct current loads, and circuits with filament lamps where the closing of contacts can produce current peaks of up to 10 or 15 times the nominal strength (public or industrial lighting systems). It can also be used for starting small electric motors and other appliances that produce high transient currents. The OKSCD relay has an electrical life expectancy equal to that of the OKS relay, but is also suitable for use with circuits generating high transient currents, given the factors indicated above. Controlling a circuit with 600W filament lamps connected to a 110Vac supply, for example, the OKSCD relay is capable of 1,500,000 operations.

OKSGCCD

The OKSGcCd relay has a longer electrical life expectancy than the OKSCd model. It has 4 normally open contacts, and a distance between contacts of > 4mm. Magnetic arc blow-out is fitted as a standard feature. The OKSGcCd relay can be used with heavily inductive d.c. loads, where there is no need for change-over contacts.

SPECIAL ITALIAN NAVY SPECIFICATION

OK, OKS, OKFC and OKSFC models can be made in a special Italian Navy version, which features gold-plated terminals and contacts and tropicalization of the relay coil. A special fixing bracket can be supplied, made of 304 grade stainless steel, which replaces the classic retaining clip.

MODELS	NUMBER OF CONTACTS	CONTINUOUS DUTY	MAGNETIC ARC BLOW-OUT	AgCdO CONTACTS	LONG TRAVEL	ROLLING STOCK APPLICATIONS
OK	4 ⁽¹⁾					
OKS			•			
OKFC		•				
OKSFC		•	•			
OKSCd			•	•		
OKSGcCd			•	•	•	
OKUIC		•	•			•

1. Versions with 8 and 12 contacts available (excluding OKUIC, OKSCd and OKSGcCd).

FOR PRODUCT CODE CONFIGURATION, SEE THE "ORDERING SCHEME" TABLE

COIL DATA	OK - OKS	OKFC - OKSFC	OKSCD - OKSGCCD	OKUIC
Nominal voltages Un ⁽¹⁾	DC: 12-24-36-48-72-110-125-132-144-220		AC: 12-24-48-110-115-127-220-230-380	
Max. consumption at Un (DC/AC) ⁽²⁾	4.5 W / VA	3.5 W / VA	5 W / VA	3.5 W
Operating range ⁽¹⁾	DC: 80...110% Un AC: 85...115% Un	DC: 80...120% Un AC: 85...115% Un	DC: 80...110% Un AC: 80...110% Un	DC: 70...125% Un ⁽³⁾
Type of duty	Continuous at Un ⁽⁴⁾	Continuous	Continuous at Un ⁽⁴⁾	Continuous
Drop-out voltage ⁽⁵⁾	DC: > 5% Un		AC: > 15% Un	

1. Other values on request.

2. For versions with 8 and 12 contacts, double and treble the value respectively.

3. For operating ranges different to that specified by EN60077, refer to table "OKUIC - Special Ranges".

4. Continuous duty is possible at the maximum voltage of the operating range at Tmax: 40 °C.

5. Limit value for supply voltage, expressed as % of the nominal value, beneath which the relay is certain to be de-energized.

CONTACT DATA	OK - OKS - OKFC - OKSFC - OKUIC	OKSCD	OKSGCCD		
Number and type ⁽¹⁾	4 SPDT, Form C	4 SPDT, Form C	4 N.O.		
Current					
Nominal ⁽²⁾	10 A	10 A			
Maximum peak (1 min) ⁽³⁾	20 A	20 A			
Maximum pulse (10 ms) ⁽³⁾	150 A	250 A			
Example of electrical life expectancy ⁽⁴⁾ 1,800 operations/hour	OK	0.7 A – 120 Vdc – L/R 0 ms : 5.5 x 10 ⁵ operations			
	OKS	1 A – 120 Vdc – L/R 40 ms : 5 x 10 ⁵ operations			
	OKFC	0.5 A – 110 Vdc – L/R 40 ms : 10 ⁵ operations			
	OKSFC - OKUIC	0.7 A – 132 Vdc – L/R 40 ms : 10 ⁵ operations			
	OKSCd	1 A – 120 Vdc – L/R 40 ms : 5 x 10 ⁵ operations			
	OKSGcCd	5 A – 110 Vdc – L/R 20 ms : 2 x 10 ⁵ operations			
Minimum load ⁽⁵⁾	Standard contacts	500 mW (20V, 20 mA)			
	Gold-plated contacts ⁽⁶⁾	200 mW (20V, 5 mA)			
Maximum breaking voltage	350 Vdc / 440 Vac				
Contact material	AgCu		AgCdO		
Operating time at Un (ms) ⁽⁷⁾⁽⁸⁾	OK-OKS-OKSCd	OKFC-OKSFC	OKSGcCd	OKUIC	
	DC – AC				
	Pick-up (NO contact closing)	≤ 28 - ≤ 40	≤ 38 - ≤ 40	≤ 30 - ≤ 45	≤ 40
	Drop-out (NC contact closing)	≤ 20 - ≤ 70	≤ 18 - ≤ 80	-	≤ 18

1. Versions with 8 and 12 SPDT contacts available, excluding OKUIC, OKSCd and OKSGcCd.

2. On all contacts simultaneously.

3. The max. peak and pulse currents are those currents that can be handled, for a specified time, by the contact. They do not refer to steady or interrupted currents.

4. For other values, see electrical life expectancy curves.

5. Values referred to a new product, measured in laboratory. The ability to maintain this performance over the time depends on the environmental conditions and the contact' frequency use. The use of gold plated contacts is recommended in the case of very low loads.

6. Specifications of contacts on new relay

a. Plating material: P4GEO: gold-nickel alloy (>6µ).

b. When the gold-plated contact is subject to heavy loads, it will be degraded on the surface. In such case, the characteristics of the standard contact should be taken into consideration. This does not impair relay operation.

7. Unless specified otherwise, the operating time signifies until stabilization of the contact (including bounces).

8. Addition of a flyback diode connected in parallel with the coil (DC version only) causes an increase in operating time when the relay drops out.



INSULATION

Insulation resistance (at 500Vdc) between electrically independent circuits and between these circuits and ground between open contact parts	> 1,000 MΩ > 1,000 MΩ
Withstand voltage at industrial frequency between electrically independent circuits and between these circuits and ground between open contact parts between adjacent contacts	2 kV (1 min) - 2.2 kV (1 s) 2 kV (1 min) - 2.2 kV (1 s) 2 kV (1 min) - 2.2 kV (1 s)
Impulse withstand (1.2/50µs - 0.5J) between electrically independent circuits and ground between open contact parts	5 kV 5 kV



MECHANICAL SPECIFICATIONS

Mechanical life expectancy		100 x 10 ⁶ operations				
Maximum switching rate		3,600 operations / hour				
Degree of protection (with relay mounted)		IP20 / IP40 or IP50 as option ⁽³⁾				
Type of power supply, n° SPDT	VDC, 4 SPDT	VAC, 4 SPDT	VDC, 8 SPDT	VAC, 8 SPDT	VDC, 12 SPDT	VAC, 12 SPDT
Dimensions (mm) ⁽¹⁾⁽²⁾	45x97x45	45x109x45	91.5x97x45	91.5x109x45	138x97x45	138x109x45
Weight (g)	~ 280	~ 280	~ 590	~ 590	~ 890	~ 890

1. Output terminals excluded.

2. OKUIC relay: H 109mm for standard version, H 97mm for version with LED, DIODE, VARISTOR.

3. To order the relay with IP40 or IP50 protection, configure the ordering code by the "Keying position" column in "Ordering scheme".



ENVIRONMENTAL SPECIFICATIONS

Operating temperature	OKUIC	-25° to +55°C
Storage and shipping temperature		-25° to +70°C
Relative humidity		-40° to +85°C
Resistance to vibrations		Standard: 75% RH - Tropicalized: 95% RH
Resistance to shock		5g - 10 to 60 Hz - 1 min
Fire behaviour		30g - 11 ms
		V0



STANDARDS AND REFERENCE VALUES

EN 61810-1, EN 61810-2, EN 61810-7	Electromechanical elementary relays
EN 60695-2-10	Fire behaviour
EN 61000	Electromagnetic compatibility
EN 60529	Degree of protection provided by enclosures

Unless otherwise specified, products are designed and manufactured according to the requirements of the European and International standards indicated above.

In accordance with EN 61810-1, all items of technical data are referred to ambient temperature 23 °C, atmospheric pressure 96kPa and 50% humidity.

Tolerance for coil resistance, nominal electrical input and nominal power is ±7%.



RAILWAYS, ROLLING STOCK - STANDARDS

EN 60077	Electric equipment for rolling stock - General service conditions and general rules
EN 50155	Electronic equipment used on rolling stock
EN 61373	Shock and vibration tests, Cat 1, Class B
EN 45545-2	Fire behaviour, Cat E10, Requirement R26, V0
ASTM E162, E662	Fire behaviour



RAILWAYS, ROLLING STOCK - SPECIAL OPERATING RANGES FOR OKUIC RELAY ⁽¹⁾

Nominal voltage	Minimum pick-up voltage	Maximum operating voltage	Order symbol ⁽¹⁾
24 Vdc	18	33	Z01
36 Vdc	28	48	Z01
72 Vdc	1655	110	Z01
110 Vdc	77	144	Z01
128 Vdc	85	160	Z01

(1) To order the relay with the special operating range, indicate the "Z0x" symbol in the "Keying position" field of the ordering scheme.

The special range may be subject to operating specifications different from standard specifications. Please contact us for further information.



P2	Tropicalization of the coil with epoxy resin for use with 95% RH (@ T 50 °C). This treatment also protects the coil against corrosion which could occur by the combination of humidity with certain chemical agents, such as those found in acid atmospheres (typical of geothermal power stations) or saline atmospheres.
P4GEO	Gold plating of contacts with gold-nickel alloy, thickness ≥ 6µ. This treatment ensures long-term capacity of the contact to conduct lower currents in harsh ambient conditions such as acid atmospheres (typical of geothermal power stations) or saline atmospheres.
P5GEO	P4GEO gold-plating of contacts + P2 coil tropicalization.
P6GEO	P4GEO type gold-plating, but applied to contacts, contact terminals and output terminals + P2 coil tropicalization.
LED	LED indicator showing presence of power supply, wired in parallel with the coil.
FLYBACK DIODE	Polarized component connected in parallel with the coil (type 1N4007 or BYW56 for rolling stock version) designed to suppress overvoltages generated by the coil when de-energized.
VARISTOR	Non-polarized component connected in parallel with the coil, designed to suppress overvoltages higher than the clamping voltage, generated by the coil when de-energized.
TRANSIL	Non-polarized component connected in parallel with the coil. Behaviour is similar to that of a varistor, with faster operating times.
IP40	IP40 protection with “6” handle or closure with screws.
IP50	IP50 protection with “6” handle (only for 4 SPDT version).
8 CONTACTS	Version with 8 change-over contacts, obtained using 2 x 4 SPDT relay, coils connected in series.
12 CONTACTS	Version with 12 change-over contacts, obtained using 3 x 4 SPDT relay, coils connected in series.

ORDERING SCHEME



MODEL	NUMBER OF SPDT CONTACTS	APPLICATION ⁽¹⁾	CONFIGURATION A	CONFIGURATION B	TYPE OF POWER SUPPLY	NOMINAL VOLTAGE (V) ⁽²⁾	KEYING POSITION ⁽³⁾ / OPTION
OK OKS OKFC OKSFC OKUIC OKSCd OKSGcCd	4 SPDT ⁽⁴⁾ 8: 8 SPDT 12: 12 SPDT	E: Energy F: Railway Fixed Equipment R: Railway Rolling Stock M: MMI	1: Standard 2: Diode // 3: Varistor 4: Led 5: Diode // + Led 6: Varistor + Led 7: Transil 8 Transil + Led	0: Standard 2: P2 4: P4 GEO 5: P5 GEO 6: P6 GEO	C: Vdc A: Vac 50 Hz H: Vac 60 Hz	012 - 024 - 036 048 - 072 - 100 110 - 115 - 125 127 - 132 - 144 220 - 230 - 280	XXX A = IP50 B = IP40

Example	OKS	M	1	6	H	115	
	OKSM16-H115 - OKS relay, ITALIAN NAVY series, nominal voltage 115 Vac 60 Hz, with P6 GEO finish (P4GEO gold-plated contacts + P2 coil tropicalization)						
	OKSFC	E	2	0	C	110	
OKSFCE20-C110 - OKSFC relay, ENERGY series, nominal voltage 110 Vdc, equipped with flyback diode							

(1) **E = ENERGY:** all applications, except for railways rolling stock.

Suitable on energy production, transport and distribution plants, railways fixed equipment, petrochemical and heavy industry.

R = RAILWAYS, ROLLING STOCK: Application on board rolling stock (rail-tram-trolley vehicles). Electrical characteristics according to EN60077.

Availables also the product series:

RAILWAYS, FIXED EQUIPMENT: Approved and conforming relays and products to RFI (FS Group) specification no. RFI DPRIM STF IFS TE 143 A

For the list of RFI approved and conforming products, consult dedicated catalogue “RAILWAY SERIES – RFI APPROVED”.

MMI: execution for Navy. Only OK, OKS, OKFC, OKSFC, OKSCd models. P6 GEO processing as standard (please see the column “Configuration B”).

STATIONS: ENEL approved material meeting LV15/LV16 specifications.

For the list of ENEL approved and conforming products, consult the dedicated catalogue “STATIONS SERIES – LV15-LV16-LV20”.

(2) Other values on request. Voltage 380V available as Vac only.

(3) Optional value. The positive mechanical keying is applied according to the manufacturer’s model.

(4) for the 4 contacts standard version don't fill the relative cell.



WIRING DIAGRAM

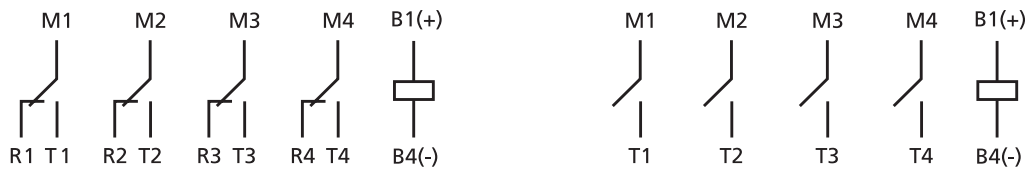

OK-OKS-OKFC-OKSFC-OKSCd-OKUIC

OKSGcCd

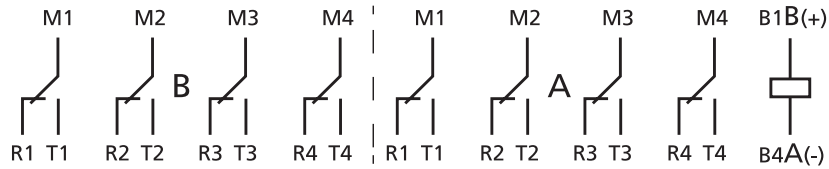

Version with 8 contacts

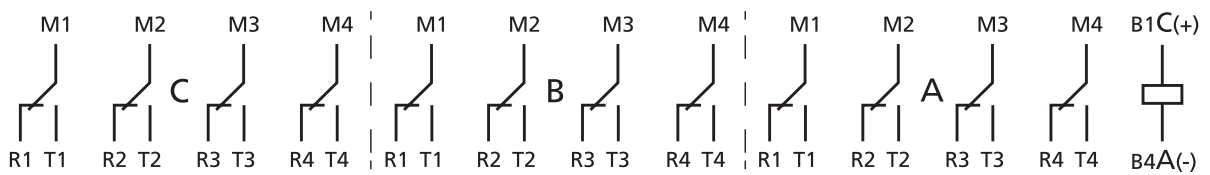

Version with 12 contacts



DIMENSIONS

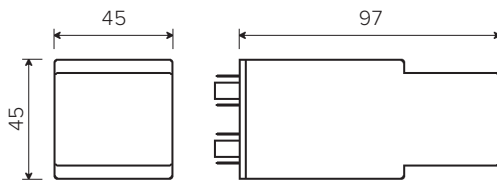

All OK d.c. relays and OKUIC with Diode and/or Led option

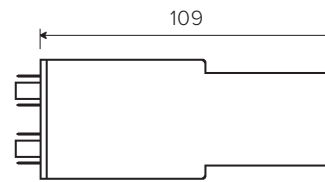

All a.c. OK and OKUIC relays

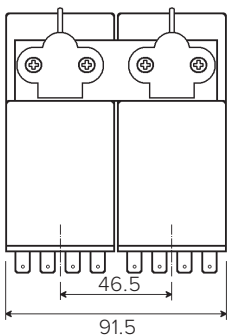

Version with 8 contacts

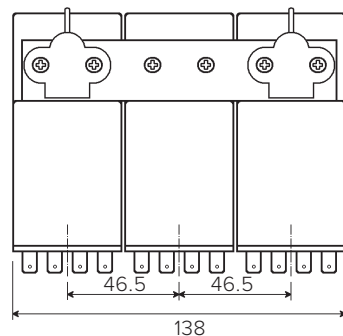

Version with 12 contacts

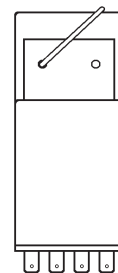

6B handle IP20 (standard)

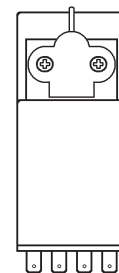

6 handle IP40 ⁽¹⁾ (OKUIC)

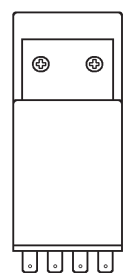

Closure with screws IP40 ⁽¹⁾

6 handle IP50 ⁽¹⁾

(1) IP40 or IP50 protection could be requested as an option. See "Ordering scheme" for code details.

EXAMPLES OF ELECTRICAL LIFE EXPECTANCY



	U (Contact)	I (A)	L/R (ms) cosφ	Operations	Notes		U (Contact)	I (A)	L/R (ms) cosφ	Operations	Notes	
OK	540Vac	3	cosφ = 0.5	15,000	②	OKFC	220Vac	10	cosφ = 0.7	500,000		
	380Vac	15	cosφ = 1	10,000	②		110Vdc	0.5	L/R = 5	1,000,000		
		10 3x3.3	cosφ = 1 cosφ = 0.8	200,000 200,000	◆		80Vdc	1	L/R = 0	2,000,000		
	OK	220Vac	20	cosφ = 1	20,000	②	OKSFC OKUIC	120Vdc	15 8 6 3 1	L/R = 0 L/R = 0 L/R = 10 L/R = 10 L/R = 10	100 2,000,000 500,000 100,000 500,000	② ③ ②
			15	cosφ = 0.5	20,000	②						
			10	cosφ = 1	400,000	◆						
			3x6	cosφ = 0.8	200,000	●						
			5	cosφ = 1	1,500,000							
			5	cosφ = 1	3,000,000							
			2.5	cosφ = 0.25	2,000,000							
2		cosφ = 1	15,000,000									
1.25		cosφ = 1	30,000,000									
120Vdc		1.5	L/R = 0	550,000		80Vdc		25 15 10	L/R = 0 L/R = 20 L/R = 0	100 100 400,000	② ②	
48Vdc	10 1.5	L/R = 0 L/R = 5	1,000,000 18,000,000		7.5 5		L/R = 0 L/R = 10	1,500,000 400,000				
OKS	400Vdc	6	L/R = 10	100	③	OKSCd	400Vdc	6	L/R = 10	100	③	
	250Vdc	15	L/R = 0	1,000	■		250Vdc	15 3 1 1 0.1	L/R = 0 L/R = 20 L/R = 10 L/R = 0 L/R = 15	1,000 300,000 30,000 1,000,000 3,500,000	② ② ② ②	
		3	L/R = 20	300,000	②							
		1	L/R = 10	30,000	②							
		0.1	L/R = 15	3,500,000	②							
	120Vdc	30	L/R = 0	100	③ ■		120Vdc	20 10 10 5 1 1	L/R = 0 L/R = 10 L/R = 0 L/R = 10 L/R = 40 L/R = 10	10,000 1,000 300,000 60,000 500,000 1,000,000	② ②	
		20	L/R = 0	10,000	② ■							
		10	L/R = 10	1,000	■							
		10	L/R = 0	300,000	②							
		5	L/R = 10	60,000								
2		L/R = 100	50,000									
1		L/R = 40	500,000									
1	L/R = 10	1,000,000										
48Vdc	10 1.5	L/R = 0 L/R = 5	2,600,000 25,000,000		48Vdc	10 3 1.5	L/R = 0 L/R = 30 L/R = 5	2,600,000 400,000 25,000,000				
24Vdc	30	L/R = 50	200,000	④		24Vdc	30	L/R = 50	200,000	④		

Notes:

- ② 2 contacts connected in series
- ③ 3 contacts connected in series
- ② 2 contacts connected in parallel
- ③ 3 contacts connected in parallel
- ④ 4 contacts connected in parallel

- Electric arc to core
- ◆ 3Hp motors
- Incandescent lamps

The breaking capacity is the level of current that the relay can break and handle without being destroyed, and without causing an electric arc of unacceptable and hazardous duration. Breaking capacity is also referred to as interrupting capacity, or rating.

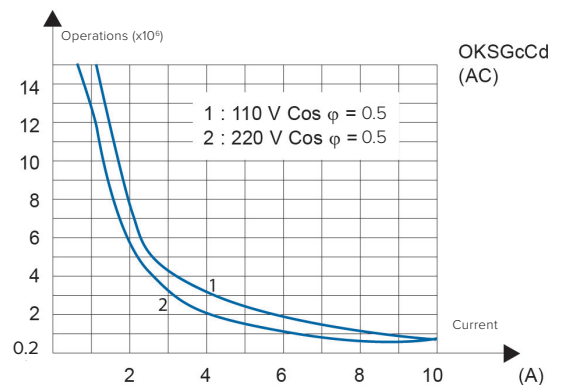
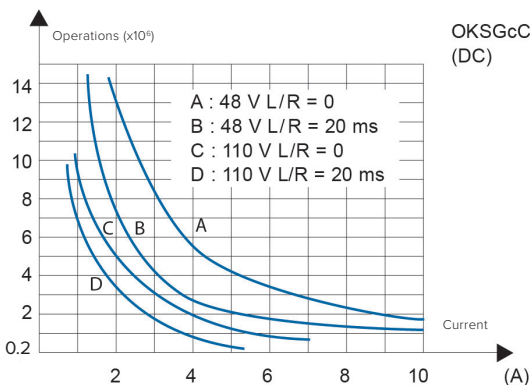
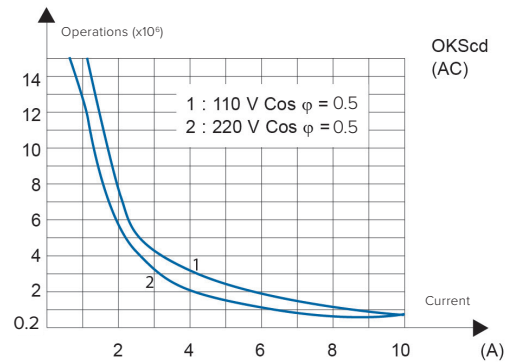
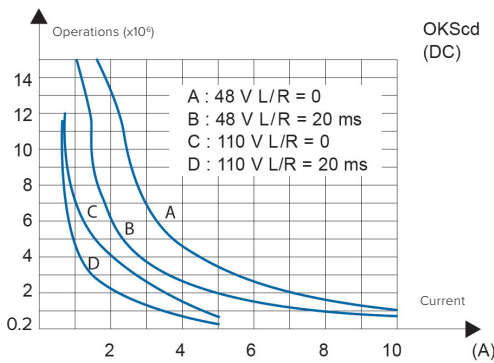
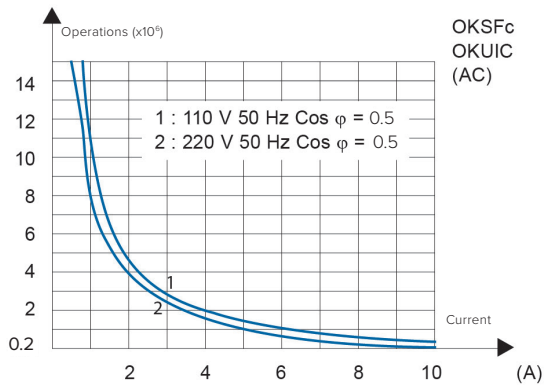
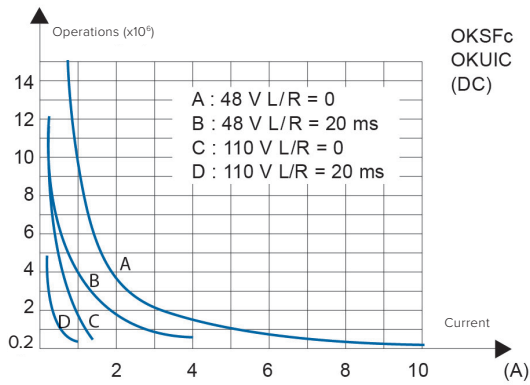
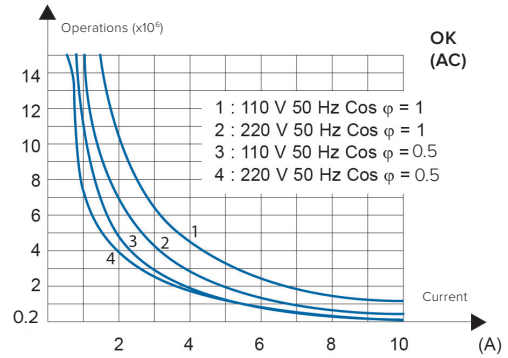
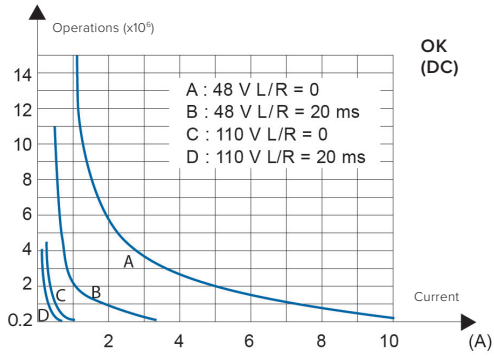

(I) Switching frequency 1,200 operations/hour, 50% cycle.

SOCKETS	OK SERIES, 4 SPDT ⁽¹⁾	
For wall or rail mounting		
Spring clamp, wall or DIN H35 rail mounting		PAIR160
Screw, wall or DIN H35 rail mounting		48BIP20-I DIN
Screw, wall mounting		48BL
For flush mounting		
Spring clamp		PRIR160
Double faston (4.8 x 0.8 mm)		ADF2
Screw		43IL
For mounting on PCB		
		65

1) For version with 8 and 12 contacts, assume 2 and 3 sockets respectively for each relay. In this instance, the mounting distance between centres of the sockets must be 45mm. The ADF socket cannot be used.

For more details, see specifications of mounting accessories.

RETAINING CLIPS (correspondence with sockets)	OK SERIES - $V_{supply} = V_{DC}$	OK SERIES - $V_{supply} = V_{AC}$ OKUIC	OKUIC with LED / VR / DIODE
Number of clips per relay	1, 2 for version with 8-12 SPDT contacts	1, 2 for version with 8-12 SPDT contacts and OKUIC	2
SOCKET MODEL	CLIP MODEL		
For wall or rail mounting			
PAIR160, 48BIP20-I DIN, 48BL, 48L	RC48	RL48	RC48
For flush mounting			
PRIR160	RC48	RL48	RC48
ADF2	RC48	RL48	RC48
43IL ⁽²⁾	RC43	RL43	RC43
For mounting on PCB			
65	RC43	RL43	RC43

(1) Insert the clip before fastening the socket on the panel.

INSTALLATION, OPERATION AND MAINTENANCE

Installation

Before installing the relay on a wired socket, disconnect the power supply.

The preferential mounting position is on the wall, with the relay positioned horizontally in the "reading orienting" of marking so that the label is readable in the correct sense.

Spacing: the distance between adjacent relays depends on use' conditions.

If a relay is used in the "less favorable" conditions that occur with "simultaneously":

- Power supply: the maximum allowed, permanently
- Ambient temperature: the maximum allowed, permanently
- Current on the contacts: the maximum allowed, permanently
- Number of contacts used: 100%

it is strongly recommended to space relay at least 5 mm horizontally and 20 mm vertically, to allow for proper upward heat' dissipation and increase the longevity of the component.

Actually, relays could be used in less severe conditions. In this case, the distance between adjacent relays can be reduced or abolished. A correct interpretation of the use' conditions allows the optimization of the available spaces. Contact AMRA for more information.

To increase relay' longevity, we recommend mounting relays intended for "continuous use" (permanent power supply), alternating them with relays intended for less frequent use.

For a safe use, the retaining clip is recommended.

For use on rolling stock, relays have been tested to EN 61373 standard equipped with retaining clip(s).

Operation

Before use: if relay is not used, for example after long storage periods, contact resistance may increase due to a natural and slight oxidation or polluting deposits.

In order to restore the optimal conductivity and for standard contacts (NOT gold plated) it is recommended to switch several time a load of at least 110Vdc - 100mA or 24Vdc - 500mA. The contacts will be "cleaned" thanks to the electric arc generated during the current interruption and the mechanical self-cleaning action.

The common contact rubs against the fixed poles (NO and NC contacts) both when opening and when closing, which ensures a self-cleaning action.

An increase in contacts' resistance, in most cases, does not represent a problem. Many factors contribute to the correct use of contact and consequently to the relay' long-term reliability:

- **Load:** the current switching generates an electric arc with cleaning effects. For proper electrical cleaning and performance keeping we recommend:
 - o Standard contacts: Minimum current = 20mA
 - o Gold plated contacts: Minimum current = 10mA
- **Operating frequency:** relays are components that can operate with a wide range of switching frequency. High frequency operation also allows a continuous cleaning effect by "sliding" (mechanical cleaning). In case of low frequency operation (for example few time a day), we advise:
 - o Use of contact with currents twice compared to those indicated.
 - o For currents lower than 10mA, use gold plated contacts and connect 2 contacts in parallel, in order to reduce the equivalent contact resistance
- **Pollution:** the presence of pollution can cause impurities on contact surface. Electric charges attract organic molecules and impurities that are deposited on the contact surface. Electrical and mechanical cleaning, respectively, burn and remove such impurities. In pollution presence, the minimum recommended currents must be respected. In extreme cases, provide double the cleaning current.

Condensation is possible inside the relay when energized and the outside ambient temperature is cold; this is quite normal and does not affect the operation of the relay. Plastic materials of relay do not possess hygroscopic properties.

Maintenance

No maintenance is required.

In case of normal relay wear (reaching the end of electrical or mechanical life), the relay cannot be restored and must be replaced.

To check the component, relay removal must be carried out with slight lateral movements. An "up and down" movement can cause terminals damage.

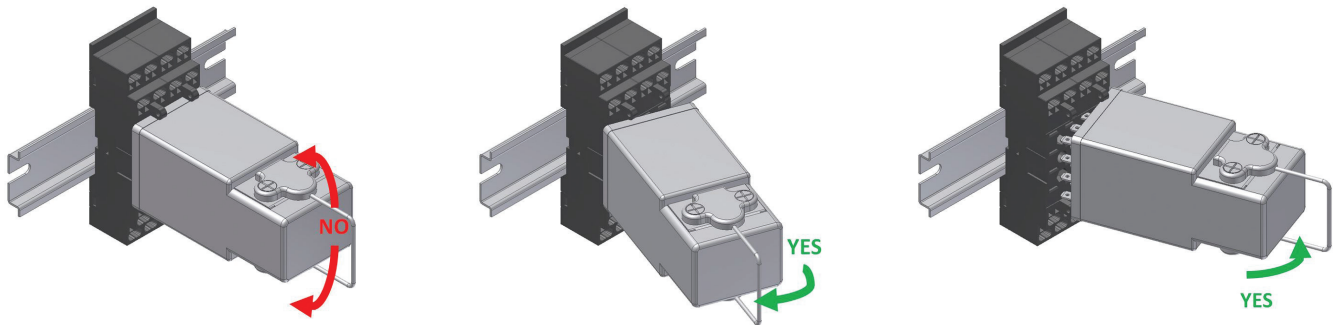

Often the malfunctions are caused by power supply with inverted polarity, by external events or by use with loads exceeding the contact performance.

In case of suspected malfunction, energize relay and observe if mechanical operation of contacts / relay mechanism is performed. Pay attention to the power supply polarity, if relay is equipped with polarized components (example: diode, led).

- In case of expected operation, clean the contacts (see paragraph "OPERATION") and check if the circuit load ranges within the contact performance. If necessary, replace with relays with gold contacts. Note: the electrical continuity of contacts must be checked with adequate current.
- If it does not work, we recommend to use a relay of the same model and configuration.

If an investigation by AMRA is required, pull-out the relay from the socket, don't remove the cap, avoid any other manipulation and contact us. You will be asked for the following data: environmental conditions, power supply, switching frequency, contact load, number of operations performed.

The fault can be described through the "TECHNICAL SUPPORT" section of the website www.amra-chauvin-arnoux.it.

In any case, the relay cannot be repaired by the user.

Storage

Storage conditions must guarantee the environmental conditions (temperature, humidity and pollution) required for the product conservation, in order to avoid deterioration.

The product must be stored in an environment sheltered from atmospheric agents and not polluted, with an ambient temperature between -40 and + 85 ° C with max 80% RH. Humidity can reach peaks of 95%. In any case, there must be no condensation. Before use, please read carefully "OPERATION" section.