

OY826S



Safety light curtain

OYA0760-40-4-18-P-1-B

For 8-wire cordsets the core colors are not standardized.
Please note the wiring of the sensor and the cordsets (see data sheet).

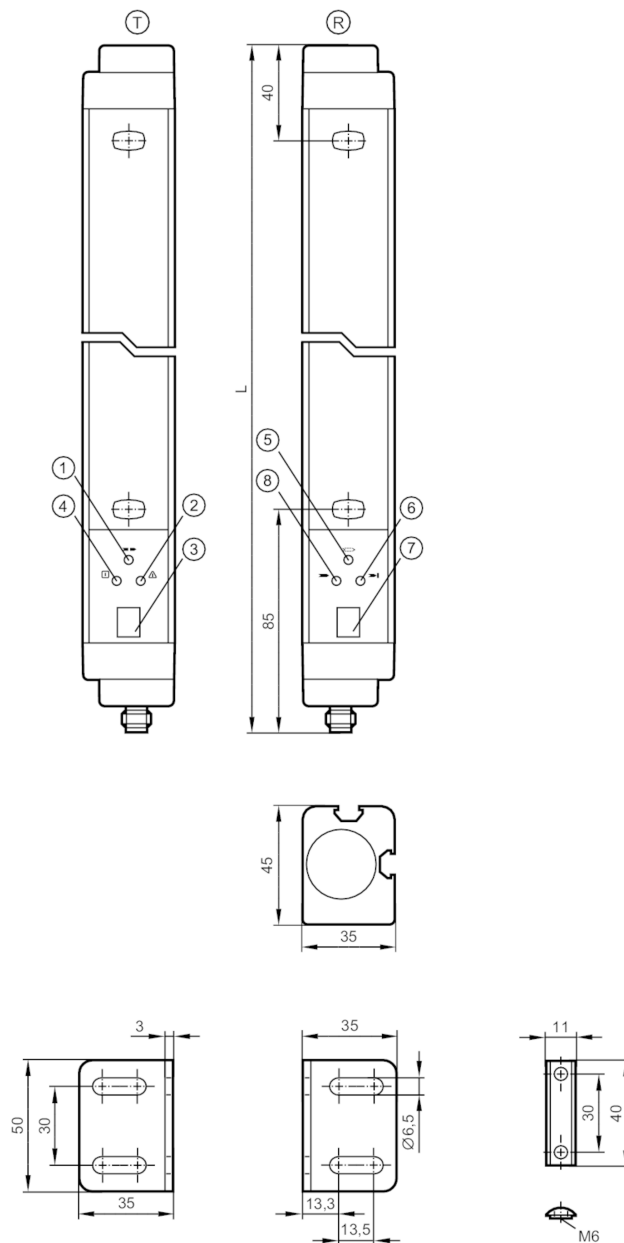

- T transmitter
- R receiver
- 1 LED yellow
- 2 LED red
- 3 7-segment LED display
- 4 LED green
- 5 LED yellow
- 6 LED red
- 7 7-segment LCD display
- 8 LED green





Safety light curtain

OYA0760-40-4-18-P-1-B

Product characteristics		
Type of light		Infrared light
Electrical design		PNP
Protection		IP 65
Application		
Protective function		Access prevention hand protection
Electrical data		
Operating voltage tolerance	[%]	20
Operating voltage	[V]	24 DC
Protection class		III
Reverse polarity protection		yes
Power-on delay time	[s]	< 18
Type of light		Infrared light
Wave length	[nm]	950
Receiver		
Current consumption	[mA]	125
Transmitter		
Current consumption	[mA]	83
Outputs		
Electrical design		PNP
Number of OSSD outputs		2
Max. current load per OSSD output	[mA]	500; (24 V)
Short-circuit protection		yes
Monitoring range		
Protected area height	[mm]	760
Resolution (detection capacity d)	[mm]	40
Protection area width (low light intensity)	[m]	0...6
Protection area width (high light intensity)	[m]	3...18
Floating blanking		yes
Reaction times		
Response time	[ms]	9.5
Operating conditions		
Applications		Class C to EN 60654-1 weatherproof application
Ambient temperature	[°C]	0...55
Max. relative air humidity	[%]	95
Protection		IP 65
Tests / approvals		
EMC		IEC 61496-1
Shock resistance		IEC 61496-1
Vibration resistance		IEC 61496-1

OY826S



Safety light curtain

OYA0760-40-4-18-P-1-B

Safety classification

ESPE type (IEC 61496-1)	4
Complies with the requirements	ISO 13849-1: 2015 Category 4, PL e
	IEC 61508 SIL 3
	IEC 62061 SIL 3
Mission time TM [h]	175200
PFH [1/h]	1,2E-08

Mechanical data

Weight [g]	4800
Dimensions [mm]	861 x 35 x 45
Material	housing: aluminum; front lens: PC
Length L [mm]	861

Displays / operating elements

Display	transmitter	3 x LED
	transmitter	7-segment LCD display
	receiver	3 x LED
	receiver	7-segment LCD display

Accessories

Items supplied	Assembly angle: 4
	Slot nuts: 4
	screws

Remarks

Pack quantity	1 pcs.
---------------	--------

Electrical connection - receiver

Connector: 1 x M12; coding: A; Maximum cable length: 100 m; for wire cross-section 0.34 mm²

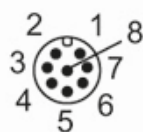

OY826S



Safety light curtain

OYA0760-40-4-18-P-1-B

Connection

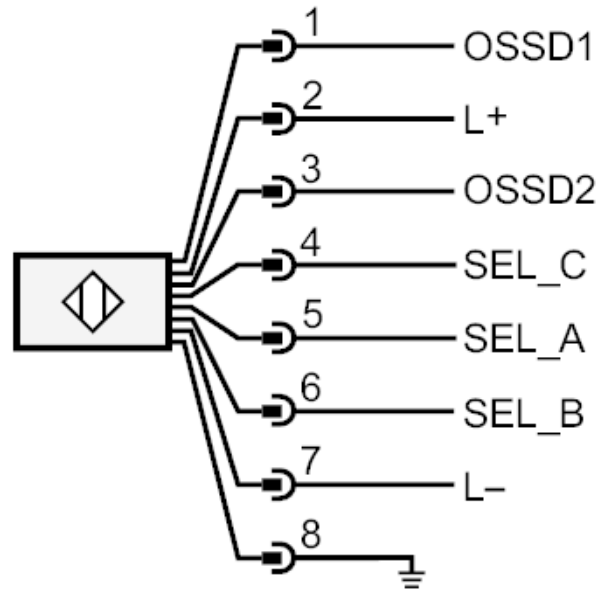

Electrical connection - transmitter

Connector: 1 x M12; coding: A



OY826S



Safety light curtain

OYA0760-40-4-18-P-1-B

Connection

