



**VSE**  
D - 58809 flow   
Type: VRLI-1S10/EX  
Serial-Nr.: 001  
Baujahr: 03/09

**GEAR FLOW METER VHM**

## GEAR FLOW METER VHM SERIES

We have developed a high precision flow meter for a wide variety of liquids, especially liquids with high abrasiveness and poor lubricity.

Applications include: chemical, petrochemical, pharmaceutical and cosmetic industry, two-component mixers, paints, aviation.

VHM flow meters are dead space optimised for use in the paint industry and for paint spraying systems (easy flushing).

They are positive displacement units based on the meshing gear principle. Each tooth generates an impulse by recognition of the gear rotation by a non-contact detection system according to the carrier frequency principle.

VHM flow meters are available with single, double or quadruple resolution, signal-output with NPN- or PNP-switching mode.

Signal pick-ups with -certification (Ex ia IIC T4 ... T6) and signal pick-ups with a fibre optic output are applicable for hazardous locations.

### TECHNICAL DATA

Size	Flow range		K-factor Imp./l	
	l/min	GPM	Imp./l	Imp./Gal.
VHM 01-2	0.01 ... 1 l/min	0.003 ... 0.264	approx. 22,000	approx. 87,000
VHM 02-1	0.05 ... 2 l/min	0.013 ... 0.528	approx. 8,800	approx. 33,311.872
VHM 02-2	0.10 ... 4 l/min	0.026 ... 1.056	approx. 4,400	approx. 16,655.936
VHM 02-3	0.40 ... 8 l/min	0.106 ... 2.113	approx. 2,200	approx. 8,327.968
VHM 03-2	0.50 ... 20 l/min	0.132 ... 5.283	approx. 1,000	approx. 3,785.44

Materials	
Body	Stainless steel 1.4404 (316)
Gears	Stainless steel 1.4462 (316)
Bearings	Tungsten carbide
Seals	FEP-FKM (standard) NBR (upon request) PTFE (upon request)
K-factor	See calibration certificate for precise data

Special designs and materials are available on request.

Accuracy	up to 0.5% up to 1%	Viscosity > 10 mm <sup>2</sup> /s Viscosity 1 - 10 mm <sup>2</sup> /s
Repeatability	+/- 0.5‰	Under same operating conditions
Max. operating pressure	250 bar	3625 psi
Medium temperature	-20 ... +120 °C	-4 ... +248 °F
Viscosity range	1 - 20.000 mm <sup>2</sup> /s	
Mounting positions	Freely selectable	

The installation into the pipe line can be made by means of a mounting plate or manifold.

### APPLICATIONS

<b>Chemical industry</b>	→	Continuous dosing
<b>Pharmaceutical industry</b>	→	Mixing, batching
<b>Cosmetic industry</b>	→	Dosing, batching
<b>Dyes and paints</b>	→	Flow control, consumption monitoring
<b>2-Component mixers</b>	→	Monitoring, regulation of mixing ratio

## DIMENSIONS

### FLOW METER DIMENSIONS

Size	∅ A	B	C	D	∅ E	F	G	K	L	M	H	Weight (kg)
VHM 01-2	68	29	44	18	5	6	M6					0.760
VHM 02-1	68	29	44	18	6	6	M6					0.740
VHM 02-2	68	34	44	18	6	6	M6					0.860
VHM 02-3	68	43	44	18	6	6	M6					1.075
VHM 03-2	99	50		27	10			25	81	M6	12	2.700

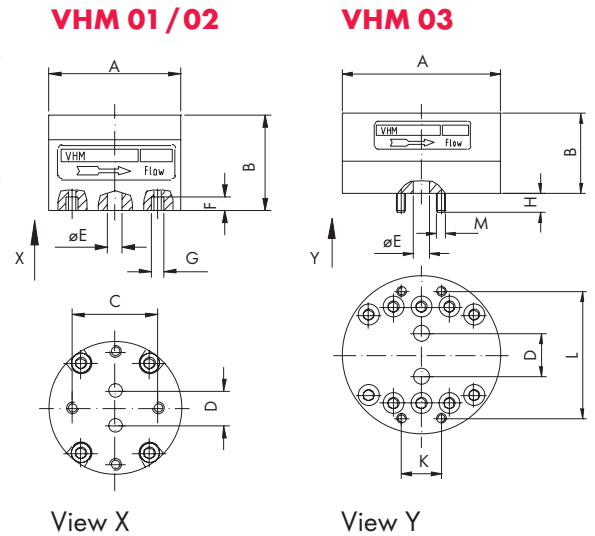

### SUBPLATES DIMENSIONS

Type	A	B	C	D	E	F	G	H	L	M	N	P	O-ring
AHM 01-... AN/.	∅ 68	52	16	20	∅ 6	24	G 1/8	M6	∅ 11				7.65 x 1.78
AHM 02-... BN/.	∅ 68	52	16	20	∅ 6	24	G 1/4	M6	∅ 11				7.65 x 1.78
AHM 03-... CN/.	∅ 98	70			∅ 10	35	G 3/8	M6	∅ 15.5	25	81	13.5	12.42 x 1.78
AHM 03-... DN/.	∅ 98	70			∅ 10	35	G 1/2	M6	∅ 15.5	25	81	13.5	12.42 x 1.78

#### AHM 01 - .S... AHM 02 - .S...

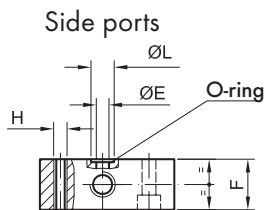

#### AHM 03 - .S...

Side ports

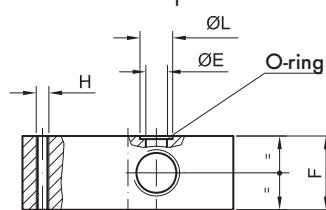

#### SIDE PORT CONNECTION

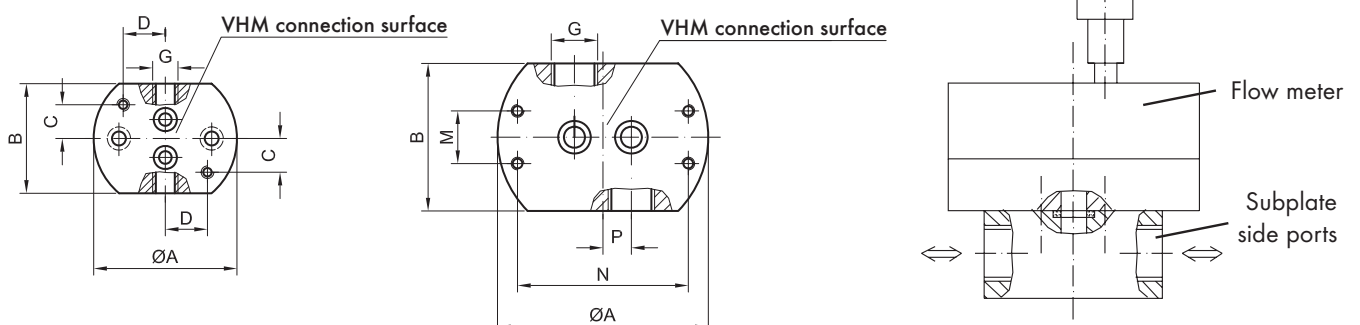

## TYPE CODES

Flow meter VHM	Size	Factory preset <input type="checkbox"/>										
	Type of seal	O-ring with FPM - core FEP-FPM = [F]										
	Type of connection	Subplate = [P] Piping = [R]										
	Housing material: stainless steel	V 2 A = [2] V 4 A = [4]										
	Backlash (factory preset)	Reduced tolerance = [1] Normal tolerance = [2] Increased tolerance = [3]										
	Measuring range	<table border="1"> <tr> <td>0.01-1 /min</td> <td>0.05-2 /min</td> <td>0.1-4 /min</td> <td>0.4-8 /min</td> <td>0.5-20 /min</td> </tr> <tr> <td>[2]</td> <td>[1]</td> <td>[2]</td> <td>[3]</td> <td>[2]</td> </tr> </table>	0.01-1 /min	0.05-2 /min	0.1-4 /min	0.4-8 /min	0.5-20 /min	[2]	[1]	[2]	[3]	[2]
	0.01-1 /min	0.05-2 /min	0.1-4 /min	0.4-8 /min	0.5-20 /min							
	[2]	[1]	[2]	[3]	[2]							
	Size flow meter VHM	[01] [02] [03]										
	<b>Combination VHM/AHM</b>	<table border="1"> <tr> <td>VHM</td> <td>..... / .</td> </tr> <tr> <td>AHM</td> <td>..... / .</td> </tr> </table>	VHM	..... / .	AHM	..... / .						
VHM	..... / .											
AHM	..... / .											
Subplate AHM Size	[02] [03]											
Subplates AHM												
Housing material: Stainless steel	V 2 A = [2] V 4 A = [4]											
Connection orientation	Side connection = [S] Bottom connection = [U]											
Type of connection (other types on request)	G 1/8 = [A] G 1/4 = [B] G 3/8 = [C] G 1/2 = [D]											
Design	Standard = [N] Special = [S]											
Series	Factory preset = <input type="checkbox"/>											

**Type key**  
**Signal pick-up**

### GENERAL PRINCIPLE OF FUNCTIONING

The two gear wheels of the instrument are set into motion by the volume flow passing through the flow meter. Each tooth of the gear wheel is scanned by a single or double signal pick-up, which is screwed to the flow meter.

When the gear wheel rotates, this signal pick-up generates an electrical output impulse, when a tooth of the wheel passes the scanning range.

Each conveyed tooth gap volume corresponds to one electrical output impulse for a single signal pick-up, or 2 or 4 electrical output impulses for a double signal pick-up, depending on the jumper coding. This volume

is enclosed between the tooth gaps of the wheel and the body and is conveyed to the outlet side by the rotation of the gear wheel. The volume conveyed out of a tooth gap is designated as the measuring volume  $V_m$ , which determines the significance of the impulses depending on the size of the flow meter.

$$V_m (l/Imp.) = 1 / K\text{-factor}$$

The frequency of the output impulse signal is processed in the associated electronic circuit and is proportional to the speed of rotation of the gear wheel and to the flow velocity. The flow quantity corresponds to the conveyed volume, which is measured by constant electronic counting of the output impulses.

# TYPE CODES – SIGNAL PICK-UP

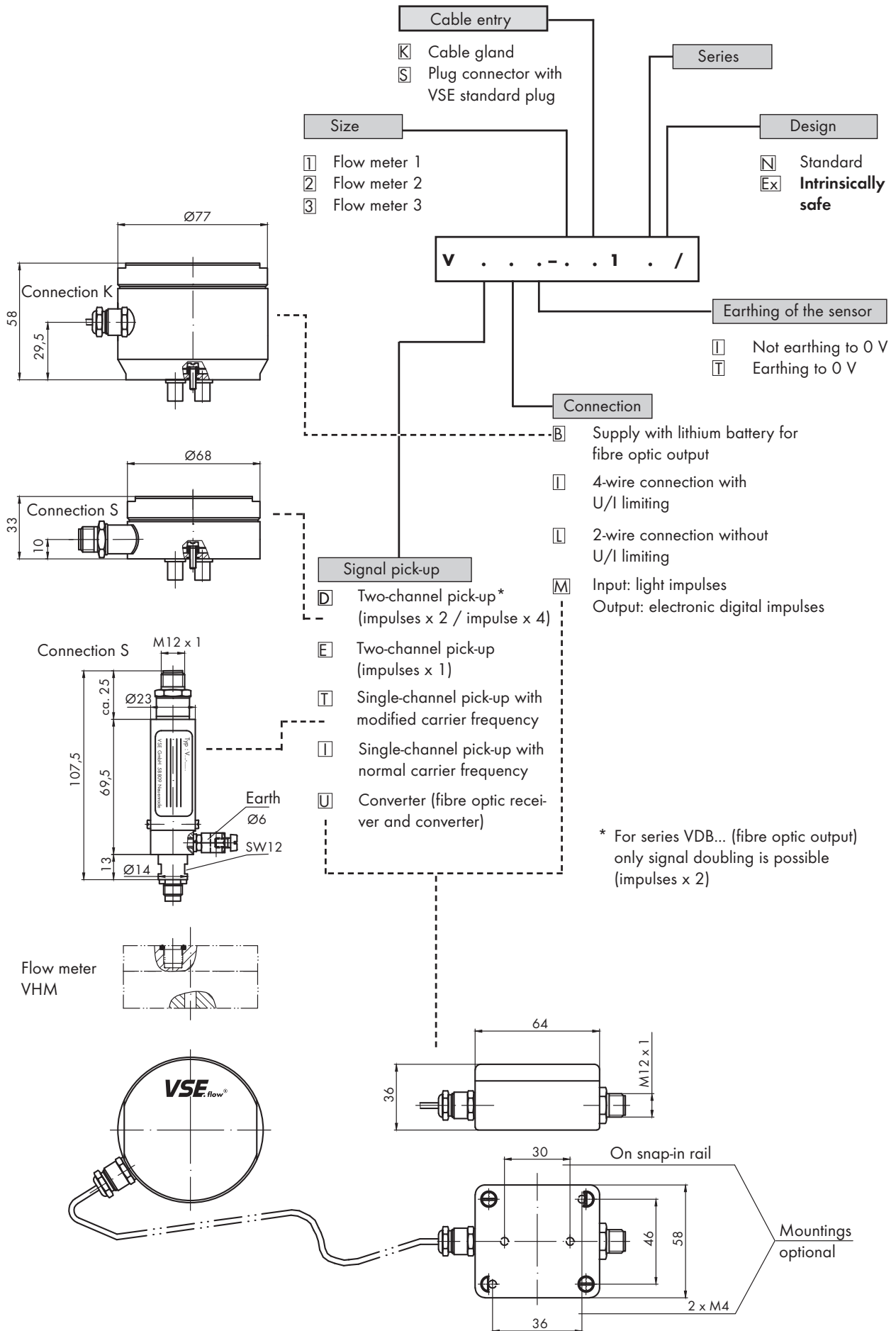

GEAR FLOW METER VHM

## SELECTION CRITERIA – SIGNAL PICK-UPS

	Single pick-ups series VI .../VT ...	Double pick-ups series VD .../VE ...
General applications	Flow velocity measurement and volume measurement	Flow velocity measurement and volume measurement with high signal resolution
Measured volume signal resolution per conveyed tooth gap volume	1 impulse/measured volume	a) 2 impulses/measured volume or 4 impulses/measured volume optionally coded by jumpers in the pick-up b) 1 impulse/measured volume in modified series VE ...
Galvanic isolation between the supply voltage and the signal output	NPN- or PNP-switching optocoupler output	NPN- or PNP-switching optocoupler output
When 2 single pick-ups are used in one flow meter body, the following possibilities arise	a) A high signal resolution and detection of the flow direction are possible with additional electronics b) Or it is possible to implement a redundant system for increased safety in conjunction with the separate operation of both pick-ups. c) Separate power supply of the single pick-ups from galvanically isolated power supply units is possible.	
<b>EX-Design</b>	With intrinsic safety only in conjunction with VSE barrier amplifier Ex-designation Ex ia IIC T4 ... T6	With intrinsic safety only in conjunction with VSE barrier amplifier Ex-designation Ex ia IIC T4 ... T6

### VHM SINGLE PICK-UPS AND DOUBLE PICK-UPS IN STANDARD DESIGN

The single pick-up operates with a carrier frequency oscillator, which is modulated when a tooth passes. This modulation is detected by the amplifier and is used to generate one digital impulse per measured volume.

The double pick-up operates with two independent carrier frequency oscillators, which are modulated when a tooth passes. This modulation is detected by the amplifier and is used to generate 2 or 4 digital impulses per measured volume, which can be selected by the coding of the internal jumpers.

Single and double pick-ups are equipped with an optocoupler transistor output, which has a galvanic isolation between supply voltage and pick-up.

This transistor output can be connected with the supply voltage of the pick-up as shown in the below connection diagrams or can be operated with a separate power supply. Depending on the polarity of the power supply to the transistor, either a PNP- or a NPN-switched output signal is generated.

#### OUTPUT SIGNAL PNP-SWITCHED

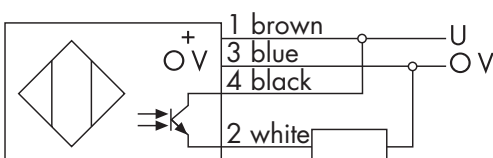

#### OUTPUT SIGNAL NPN-SWITCHED

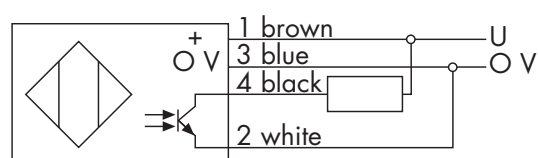

## SINGLE PICK-UPS AND DOUBLE PICK-UPS IN EX-DESIGN

The single pick-up operates with a carrier frequency oscillator, which is modulated when a tooth passes. The double pick-up operates with two independent carrier frequency oscillators, which are modulated when a tooth passes.

This modulation is detected by the amplifier and is used to generate a pulsing current signal in the supply current. The connected barrier amplifier detects the signal and generates a digital PNP signal for further processing. The output impulses per measured volume correspond to those of the two standard designs.

Single pick-ups and double pick-ups in Ex-design are designed for intrinsic safety and may only be used in conjunction with the VSE barrier amplifier MK 13-P-Ex 0/24 V DC/K15.

The flow meter with the single pick-up or double pick-up is located in the hazardous area. The barrier amplifier is installed outside the hazardous area in an electrical cabinet or terminal box (snap-in mounted on an installation rail DIN 50022).

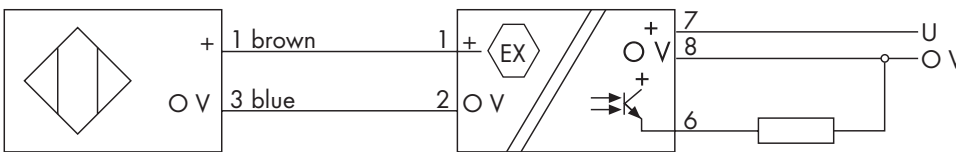

### DOUBLE PICK-UP WITH FIBRE OPTIC OUTPUT TYPE VDB...

Applications under extremely difficult conditions	Applications	Measured volume signal resolution per conveyed tooth gap volume	Battery operation with energy saving circuit
a) Environments with heavy electromagnetic interference b) High voltage areas c) Rooms with explosion hazards, e.g. spray painting equipment with electrostatic charge	In flow velocity measurement and volume measurement with high signal resolution	2 impulses / measurement volume	2 years of operation without battery change

### DOUBLE PICK-UP WITH FIBRE OPTIC OUTPUT TYPE VDB...

The double pick-up converts electrical impulses into light impulses and transmits these through a plastic optical fibre to the receiver, which is installed away from the extreme conditions. This converts the light impulses of the signal pick-up back into electrical impulses and outputs them to electronic evaluation devices for further processing. The output signal of the fibre optic receiver has a resolution of 2 impulses per measured volume with a pulse duty factor of 1:1.

The signal frequency of the output impulses is proportional to the speed of rotation of the gear wheel and to the flow velocity and must be processed by the connected electronic readout according to the values of the impulses.



The output impulses of the fibre optic receiver can be either a PNP- or a NPN-switched signal. The coding of the signals is easily possible and is performed on 2 separately programmable jumper bars in the receiver.

#### DOUBLE PICK-UP with lithium battery

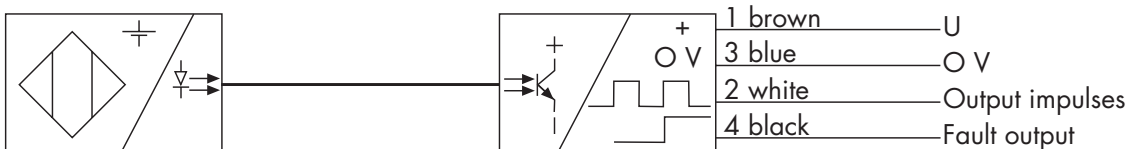
#### FIBRE OPTIC RECEIVER



## SIGNAL PICK-UPS FOR VHM FLOW METERS

Technical data part 1	Single pick-ups in standard design Deviations from Ex-design	Double pick-ups in standard design Deviations from Ex-design
Signal pick-ups per flow meter	1 or 2	2 (1 active carrier frequency oscillator in Series VE* ...)
Detection of direction of flow meter	Yes, by 2 signal pick-ups with a phase offset <sup>1</sup> of 90° mounted on one flow meter body	No
Body data		
Dimensions	Ø = 25 mm; length = 115 mm	Ø = 68 mm; length = 33 mm; overall length with sensor = 43 mm
Protection type	IP 54	IP 54
Material	Stainless steel	Anodised aluminium, coil holder in stainless steel
Weight	100 g	165 g
Medium temperature	-20 ... +120°C / -4 ... +248°F Ex-Design: -20 ... +80°C / -4 ... +176°F	-20 ... +120°C / -4 ... +248°F Ex-Design: -20 ... +80°C / -4 ... +176°F
Ambient temperature	-20 ... +60°C / -4 ... +140°F Ex-Design: -20 ... +50°C / -4 ... +122°F	-20 ... +60°C / -4 ... +140°F Ex-Design: -20 ... +50°C / -4 ... +122°F
Ex-approval	According to Conformity certificate BUS 05 ATEX E 121X	According to Conformity certificate BUS 05 ATEX E 121X
Ex-designation	 II 1G Ex ia IIC T4...T6	 II 1G Ex ia IIC T4...T6
Ex-ignition suppression type in conjunction with specified VSE amplifier	Intrinsically safe MK 13-P-Ex 0/24 V DC/K15	Intrinsically safe MK 13-P-Ex 0/24 V DC/K15
Supply voltage U <sub>DC</sub>	10-30 V DC, see data sheet page 12	110-30 V DC, see data sheet page 12



<b>VSE barrier amplifier</b>			
Installation site		Outside the Ex-area in an electrical cabinet or terminal box. Mounted on installation rail DIN 50 022	Outside the Ex-area in an electrical cabinet or terminal box. Mounted on installation rail DIN 50 022
Electrical connection		Intrinsically safe control line according to design specifications VDE 0165	Intrinsically safe control line according to design specifications VDE 0165
Supply Voltage $U_{DC}$	Standard	7-30 V	7-30 V
	Ex-Design	5-9 V (by specified VSE barrier amplifier)	5-9 V (by specified VSE barrier amplifier)
Supply current $I_{DC}$	Standard	3 mA max.	3 mA max.
	Ex-Design	< 2.7 mA > 3.7 mA (modulated current signal)	< 2.7 mA > 3.7 mA (modulated current signal)
Connection general	Standard	4-wire plug connection	4-wire plug connection
	Ex-Design	2-wire plug connection	2-wire plug connection
Plug with screened cable	Standard	4-pole standard plug, plug length = 25 mm, yellow cable	4-pole standard plug, plug length = 25 mm, yellow cable
	Ex-Design	dto., blue cable	dto., blue cable
Number of signal outputs		1 or 2 (when 2 single pick-ups are used in one flow meter body)	1 or 2 (the 2 signal pick-ups are evaluated by the internal amplifier and are connected to 1 output) 1 impulse in series VE...
Signal resolution per conveyed tooth gap volume (measurement volume $V_m$ )		1 impulse or 2 impulses by 2 single signal pick-ups with a phase offset <sup>1</sup> of 90° and different carrier frequencies in one flow meter body	Optional 2 impulses (signal doubling) or 4 impulses (signal quadrupling) codable with internal jumpers 1 impulse in series VE...

### 1 Explanation of series VT ...

If detection of the direction of flow and high signal resolution with additional external circuitry is necessary, 2 single pick-ups are used in one flow meter body,

which are arranged with a mechanical offset of 90° with regard to the tooth flank sequence

## SIGNAL PICK-UPS FOR VHM FLOW METERS

Technical data part 2		Single pick-ups in standard design Deviations from Ex-design	Double pick-ups in standard design Deviations from Ex-design
Signal output voltage $U_{DC}$	Standard	7–30 V (depending on the supply voltage and loading of the optocoupler)	7–30 V (depending on the supply voltage and loading of the optocoupler)
	Ex-Design	To VSE barrier amplifier: 7.5–27.5 V; depending on the supply voltage	To VSE barrier amplifier: 7.5–27.5 V; depending on the supply voltage
Output current $I_{DC}$	Standard	10 mA max. (for supply voltage > 16 V DC)	10 mA max. (for supply voltage > 16 V DC)
	Ex-Design	VSE barrier amplifier: output circuit < 100 mA	VSE barrier amplifier: output circuit < 100 mA
Signal switching frequency $f$		3 Hz–1.0 kHz	3 Hz–1.0 kHz
Signal output circuit	Standard	Optocoupler transistor with series resistance $R = 1.2 \text{ K } \Omega$ galvanic isolation from the supply voltage potential	Optocoupler transistor with series resistance $R = 1.2 \text{ K } \Omega$ galvanic isolation from the supply voltage potential
	Ex-Design	VSE barrier amplifier: output short-circuit resistant – see data sheet. Connection to the barrier amplifier supply voltage potential.	VSE barrier amplifier: output short-circuit resistant – see data sheet. Connection to the barrier amplifier supply voltage potential.
Signal switching polarity	Standard	Optional NPN or PNP selectable by external connections	Optional NPN or PNP selectable by external connections
	Ex-Design	PNP output signal via VSE barrier amplifier, i.e. connection to the barrier amplifier supply voltage potential	PNP output signal via VSE barrier amplifier, i.e. connection to the barrier amplifier supply voltage potential
Signal pulse duty factor (p.d.f.)		p.d.f. = 1:1	Coding for signal doubling p.d.f. = 1:1 Coding for signal quadrupling: p.d.f. = dependent on the flow speed (impulse frequency) by which the impulse remains constant. <b>(Series VE* ..., p.d.f. = 1:1)</b>

### \* Explanation for series VE...

If a single pick-up (1 impulse per conveyed tooth gap volume) cannot be used in an application because of the length of its body (115 mm), **a modified double pick-up** of series VE... **(body length 43 mm)** can

be used, which operates with only one active carrier frequency oscillator and delivers the signals as a single pick-up.

VHM type list single and double pick-ups			Single pick-ups with not earthed 0 V-potential		Double pick-ups with not earthed 0 V-potential	
			Single channel pick-ups with normal carrier frequency	Singel channel pick-ups with modified carrier frequency	Double channel pick-ups with (impulses <sup>x2</sup> /impulses <sup>x4</sup> )	Double channel pick-ups modified (impulses <sup>x1</sup> )
Preferred types						
Available VS- connecting <sup>1</sup>	Standard	Size	4-wire connection with U/I-limiting	4-wire connection with U/I-limiting	4-wire connection with U/I-limiting	4-wire connection with U/I-limiting
	Ex-Design		2-wire connection with U/I-limiting	2-wire connection with U/I-limiting	2-wire connection with U/I-limiting	2-wire connection with U/I-limiting
Plug with yellow cable <sup>2</sup> 5/10/15/20 m	Standard	01	VIII-1S10/N	VTII-1S10/N	VDII-1S10/N	VEII-1S10/N
		02	VIII-2S10/N*	VTII-2S10/N*	VDII-1S10/N*	VEII-2S10/N
		03	VIII-2S10/N	VTII-2S10/N	VDII-3S10/N	VEII-3S10/N
Plug with blue cable <sup>2</sup> 5/10/15/20 m	Ex-Design	01	VILI-1 S10/Ex	VTLI-1S10/Ex	VDLI-3S10/N	VELI-1S10/Ex
		02	VILI-2S10/Ex*	VTLI-2S10/Ex*	VDLI-2S10/Ex*	VELI-2S10/Ex
		03	VILI-2S10/Ex	VTLI-2S10/Ex	VDLI-3S10/Ex	VELI-3S10/Ex

<sup>1</sup> The connecting cables are open at one end, but can be delivered with a second plug on request.

<sup>2</sup> Other cable lengths are available on request.

\* **Stock types, other types on request.**

## SIGNAL PICK-UPS WITH OPTICAL FIBRE TECHNOLOGY FOR VHM FLOW METERS

Technical data part 3	Double pick-ups with fibre optic output VDB ...	Fibre optic receiver VUM ...
Signal pick-ups per flow meter body	2	Volume impulse / fault signal
Detection of the flow direction	No	<b>Signal voltage</b> $U_{DC}$ : 9–30 V (depending on the supply voltage and loading of the signal output circuit)
		<b>Signal current</b> $I_{DC}$ : 10 mA max. (for supply voltages > 16 V DC)
Body data		
Dimensions	$\varnothing = 78$ mm; height = 62 mm; overall height with sensor 72 mm	Overall length with optical fibre and plug connector = 98 mm; L = 64 mm; B = 58 mm; H = 37 mm Mounting construction: 2 screws M4 or installation rail snap-in mounting DIN 50022
Protection type	IP 54	IP 54
Material	Anodised aluminium; coil holder in stainless steel	Aluminium
Weight	438 g	218 g
Medium temperature	-20 ... +60°C / -4 ... +140°F	
Ambient temperature	-20 ... +50°C / -4 ... +122°F	-25 ... +60°C / -13 ... +140°F
<b>Ex-approval</b>	<b>According to Conformity certificate BUS 12 ATEX E 058X</b>	<b>LED indicators:</b> LED green: ready LED red: transmission error
<b>Ex-designation</b>	<b>Ex II 16 Ex ia op is IIC T4 6a</b>	<b>Volume impulse / fault signal</b> Signal switching polarity: PNP or NPN programmable by 2 coding jumpers
Associated fibre optic receiver	VUMI-O...	
Installation site of the fibre optic receiver	Outside the Ex-area (or high voltage area) wall-mounted or in an electrical cabinet with screw or installation rail mounting DIN 50022 depending on the type.	<b>Volume impulse</b> pulse duty factor (PP) PP = 1:1
Electrical supply	By internal, sealed lithium battery (use only original parts)	Unregulated power supply with smoothing capacitor
Supply voltage $U_{DC}$	Battery 3.6 V / 16.5 Ah with integrated series resistor for Ex-applications	9–30 V
Operating time	2 years (integrated energy saving in stand-by mode)	<b>Supply current</b> $I_{DC}$ 8 mA

Technical data part 4	Double pick-ups with fibre optic output VDB ...	Fibre optic receiver vum ...
<b>Optical fibre</b>	Silicone-free plastic optical fibre cable with double sheathing	<b>Optical fibre signal input</b> <b>Signal detection:</b> by fibre optic input transistor
Stress relief	Aramide fibres	<b>Signal type:</b> Digital optical signals from double pick-up (flow meter signals; monitor signal in stand-by; battery status signals)
Outer sheath	Polyurethane red	
Outer dimensions	3.5 mm +/- 0.2	
Bending radius	> 10 mm short-term; > 50 mm permanent	
Optical fibre connector	Cable gland PG 7, length = 20 mm	
Standard cable lengths	5 / 10 / 15 / 20 m	
Number of signal outputs	1, includes information on the flow meter output impulses and status signals	2 volume impulses (flow meter) fault signals
Signal resolution per conveyed tooth gap volume (measured volume $V_m$ )	2 impulses (signal doubling)	2 impulses (signal doubling)
Switching frequency f	3 Hz- 1.0 kHz	3 Hz- 1.0 kHz
Volume impulses / fault signals- signal output circuit	Fibre optic output diode: Digital optical signals to the fibre optic receiver (volume sensor signals; monitor signals in stand-by; battery status signals)	One transistor each with series resistor $R = 1.2 \text{ k}\Omega$

## VHM – TYPE LIST OPTICAL FIBRE TECHNOLOGY

VHM	Size	Double pick-up with fibre optic output
<b>Standard</b>	01	VDBI-1K10/N
	02	VDBI-2K10/N
	03	VDBI-3K10/N*
<b>Ex-Design</b>	01	VDBI-1K10/EX
	02	VDBI-2K10/EX
	03	VDBI-3K10/EX*
* Size 03 on request		

### Accessories for double pick-up

VDBI-battery = sealed lithium battery for all double signal pick-ups

LWL cable = plastic optical fibre cable

LWL cable	5 m	LWL cable	20 m*
LWL cable	10 m	* other length of optical fibre cable on request	
LWL cable	15 m		

### Fibre optic receiver with plug connections

Body design	Screw mounting	VUMI-0S00/N
	Installation rail snap-in mounting	VUMI-0S01/N

## PERFORMANCE CHARACTERISTICS OF THE FAULT SIGNAL OUTPUT

If a low battery state is signalled, the green LED "Ready" extinguishes and the fault signal output becomes active, operation of the system remains possible for a certain time.

The green LED "Ready" is switched on and the fault signal output is reset automatically when a new battery has been installed in the signal pick-up body.

The fault signal output also becomes active on the following transmission errors of the optical fibre, by which the red LED "transmission error" also lights:

- A. Interruption of the optical fibre
- B. Incorrect connection
- C. Weak optical signal

## FLOW METER SELECTION

The correct choice (interpretation) of the type and size of flow meter is essential for a trouble-free and safe operation. Due to the large number of different applications and flow meter models, the technical data in the VSE catalogues are of a general nature. Certain characteristics of the devices depend on type, size and measuring range as well as the liquid to be measured. Please consult VSE for an exact choice of flow meter.

Special designs are available on request

## BARRIER AMPLIFIER "MK 13-P-EX 0/24 V DC/K15" FOR VHM FLOW METERS

VSE provides the barrier amplifier type "MK 13-P-Ex 0/24 V DC/K15" for the application of VHM flow meters in areas with explosion hazards. This operates in conjunction with the pick-up systems of VHM flow meters.

The barrier amplifier has an intrinsically safe control circuit and is equipped with galvanic isolation between the control and output circuits to the supply. It contains a pulse-switching, short-circuit resistant transistor output and is connected with screw terminals. The amplifier is installed in a plastic housing and is fitted with a snap-in mounting for attachment to an installation rail.

The barrier amplifier must be installed outside the Ex-area in an electrical cabinet or terminal box. The intrinsically safe control lines must be laid and marked according to the design specifications of VDE 0165.

### VIL-.../EX; VTL-.../EX

Single pick-up with plug connection

### VDL-.../EX; VEL-.../EX

Double pick-up with plug connection

### FLOW METER VHM...

### BARRIER AMPLIFIER

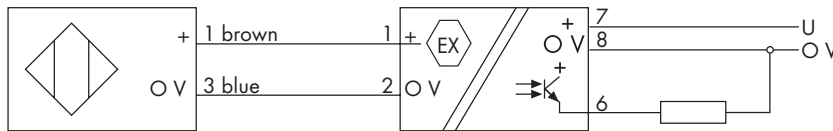

### EXTERNAL INDUCTORS / CAPACITANCE

[EEx ia] IIB

2 / 10 / 20 mH 5 / 3.5 / 3 μF

[EEx ia] IIC

1 / 5 / 10 mH 1.1 / 0.75 / 0.65 μF

## TECHNICAL DATA OF THE BARRIER AMPLIFIER MK 13-P-EX 0/24 V DC/K15

Galvanic isolation of the control and output circuits

**Ex-approval according to conformity certificate** PTB06 ATEX 2025

Control circuits intrinsically safe: II (1) GD [Ex ia] IIC

Input circuit		Output circuit		Operating values	
Sensor voltage	8.2 V	Signal output	Transistor output PNP-switched	Supply voltage	10-30 V DC
Sensor current	< 2.7 mA > 3.7 mA (modulated current signal)	Voltage drop	< 2.5 V	Current consumption short-circuit resistant	< 20 mA < 31 mA
Switching threshold	Low = < 2.7 mA High = > 3.7 mA	Switching current	< 100 mA Short-circuit resistant		
Hysteresis	> 0.2 mA	Switching frequency	< 3 kHz		

### Body

Dimensions	Length 89 mm, width 18 mm, height 71 mm
Material	Polycarbonate / ABS
Inflammability class	V-O according to UL 94
Mounting	Installation rail (DIN 50022) or G-rail (DIN 50035)
Temperature range	-25 ... +70 °C / -13 ... +158 °F
Protection range	(DIN 40050) IP 20
Weight	70 g

### LED indicators

Ready	Green LED
Switching status	Yellow LED



E Fluid Technology (Shanghai) Co., Ltd.  
Unit 104, Building 6,  
No. 650 Shunqing Lu, Shanghai  
Postal code: 201612  
China

Phone +86 21 64 77 92 06  
info@e-fluid.com  
[www.e-fluid.com](http://www.e-fluid.com)



**e.holding**  
FLUID TECHNOLOGY GROUP  
[www.e-holding.de](http://www.e-holding.de)