



- Precision Generator kW Load Protection, not affected by heavily distorted waveforms
- Total processing time less than 50mS
- 3 or 4-wire systems. Definite time trip delays
- 2-level overload protection (F version)
- Optional fast analogue kW-signal output, <50mS
- Wide range setting of overload contact hysteresis

Specifications

Monitored Voltage:	100-120V, 200-240V, 380-415V, 440-460 or 480VAC 40-70Hz (Fuse 0,5A)
Optional Separate Auxiliary Voltage AC:	100-120V, 200-240V, 380-415V, 440-460 or 480VAC 40-70Hz (Fuse 0,5A)
Optional Separate Auxiliary Voltage DC:	24, 48 or 110VDC (Fuse 2A) <small>(Add nr 2 for models with separate aux. supply. ex: KPW171C2)</small>
Supply tolerance:	± 10%
Power rating:	1,5VA
Current Input:	1 or 5A C.T. <0,1VA
Contact rating:	AC: 100VA - 250V/2A max. DC: 50W - 100V/1A max.
Adjustments available:	Depending of selected model (see page 2 and 3)
Analogue outputs:	Up to 20mA, max 500ohm Up to 10VDC, min 100kohm (other outputs available on request)
Temperature:	-20 to +70°C
Weight:	0.64kgs
Front protection:	IP52 (IP65 optional)

The unit meets EN 61010-1 Cat. III, Pollution degree 2 and the relevant environmental and EMC tests specified in EN 61326-2-4 to comply with the requirements of the major Classification Societies.

Application

The digital controlled KPW17x range provides precision (1.0%) reverse power and overload protection and monitoring of three phase generators.

Available for 3-phase 3-wire (2W3) and 4-wire (3W4) systems.

The unit measures the voltage and current true r.m.s. value, and accuracy is independent of any wave form distortion.

As standard the auxiliary voltage is taken from the unit monitored voltage input. A separate AC or DC auxiliary voltage is optionally available.

A green LED indicates POWER on. Start of monitoring function is delayed when power is switched on (default 2 secs delay). In this way false tripping during power up is avoided.

The DIN96 instrument reads the power level directly in kW. The wattmeter and the triple-zone status LEDs at a glance gives the clear safety message:

- OVERLOAD
- NORMAL
- REVERSE POWER

RELAY OUTPUTS

Relay operation depends on the selected model. Other combinations are available on request.

OUTPUTS

If output is used for remote meter reading, we recommend 0-1 mA for the slave indicator.

Related information:

The KPW17x-range is also available for rail mounting as KCW17x.

Description

Relay Operation

KPW171C - KPW171H & KPW176A - KPW176H

Reverse power relay (R1) is used to trip the generator breaker. The overload relay (R2) can be used for non-essential load release or as start signal to standby generator etc. A wide range overload hysteresis can be set to enable R2 to be used for non-essential load to be reconnected or as standby generator stop signal.

Relay R3 is intended for notification of a reverse power condition, or can be used for local indication, as input to an alarm system etc. R1 and R3 will latch after trip.

Configuration: 3-Phase, 3-Wire (2W3)

Meter: Bi-Polar 1

	REVERSE POWER	OVER LOAD	N/A	Fail Safe	Latch	Fixed Hysteresis	Adjustable Hysteresis
R1	✓			✓	*✓		
R2		✓					✓
R3	✓				*✓		

Model	Latch	Output
KPW171C*	X	-
KPW171H	-	-
KPW176A*	X	X
KPW176H	-	X

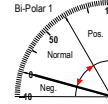

Adjustments	Trip level	Delay
Overload:	0-100% of FSD	0-30secs
Reverse Power:	0-20% of FSD	0-30secs
Hysteresis:	2-50%	

KPW171F & KPW171HF - KPW176F & KPW176HF

Reverse power relay (R1) is used to trip the generator breaker. The two individual settable overload relays (R2 and R3) can be used for non-essential load release or as start signal to standby generator etc.

R2 and R3 are non-latching and have a 10% fixed hysteresis.

Configuration: 3-Phase, 3-Wire (2W3)

Meter: Bi-Polar 1

	REVERSE POWER	OVER LOAD 1	OVER LOAD 2	Fail Safe	Latch	Fixed Hysteresis	Adjustable Hysteresis
R1	✓			✓	*✓		
R2		✓				✓	
R3			✓			✓	

Model	Latch	Output
KPW171F*	X	-
KPW171HF	-	-
KPW176F*	X	X
KPW176HF	-	X

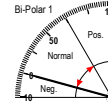

Adjustments	Trip level	Delay
Overload 1:	0-100% of FSD	0-30secs
Overload 2:	0-100% of FSD	0-30secs
Reverse Power:	0-20% of FSD	0-30secs
Hysteresis:	Fixed 10%	

KPW172A - KPW178A

The overload relay (R2) can be used for non-essential load release or as start signal to standby generator etc. A wide range adjustment for overload contact hysteresis can be set to enable R2 to be used for non-essential load to be reconnected or as standby generator stop signal.

Reverse overload relay (R1 & R3) is reverse over load protection when generator is running as motor. Reverse power relays can be used for generator trip, local indication, alarm system etc.

Configuration: 3-Phase, 3-Wire (2W3)

Meter: Bi-Polar 2

	REVERSE POWER	OVER LOAD	N/A	Fail Safe	Latch	Fixed Hysteresis	Adjustable Hysteresis
R1	✓			✓			
R2		✓					✓
R3	✓						

Model	Latch	Output
KPW172A	-	-
KPW178A	-	X

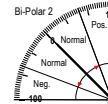

Adjustments	Trip level	Delay
Overload:	0-100% of FSD	0-30secs
Reverse Power:	0-100% of FSD	0-30secs
Hysteresis:	2-50%	

KPW172B - KPW178B

The overload relay (R2) can be used for non-essential load release or as start signal to standby generator etc. A wide range adjustment for overload contact hysteresis can be set to enable R2 to be used for non-essential load to be reconnected or as standby generator stop signal.

Reverse overload relay (R1 & R3 with different setting range) is reverse over load protection when generator is running as motor. Reverse power relays can be used for generator trip, local indication, alarm system etc.

Configuration: 3-Phase, 3-Wire (2W3)

Meter: Bi-Polar 2

	REVERSE POWER 1	REVERSE POWER 2	OVER LOAD	Fail Safe	Latch	Fixed Hysteresis	Adjustable Hysteresis
R1	✓			✓			
R2		✓				✓	
R3			✓			✓	

Model	Latch	Output
KPW172B	-	-
KPW178B	-	X

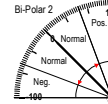

Adjustments	Trip level	Delay
Overload:	0-100% of FSD	0-30secs
Reverse Power 1:	0-20% of FSD	0-30secs
Reverse Power 2:	0-100% of FSD	0-30secs
Hysteresis:	Fixed 2%	

The MEGACON policy is one of continuous improvement, consequently equipment supplied may vary in detail from this publication.

Depending on application, select the model that matches the electrical installation. If none of the listed models fit your purpose please contact Megacon for customer adaptation.



Description

Relay Operation

KPW174C - KPW174H & KPW177A - KPW177H

Reverse power relay (R1) is used to trip the generator breaker. The overload relay (R2) can be used for non-essential load release or as start signal to standby generator etc. A wide range overload hysteresis can be set to enable R2 to be used for non-essential load to be reconnected or as standby generator stop signal.

Relay R3 is intended for notification of a reverse power condition, or can be used for local indication, as input to an alarm system etc. R1 and R3 will latch after trip.

Configuration: 3-Phase, 4-Wire (3W4)

Meter: Bi-Polar 1

	REVERSE POWER	OVER LOAD	N/A	Fail Safe	Latch	Fixed Hysteresis	Adjustable Hysteresis
R1	✓			✓	*✓		
R2		✓					✓
R3	✓				*✓		

Model	Latch	Output
KPW174C*	X	-
KPW174H	-	-
KPW177A*	X	X
KPW177H	-	X

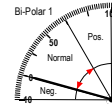

Adjustments	Trip level	Delay
Overload:	0-100% of FSD	0-30secs
Reverse Power:	0-20% of FSD	0-30secs
Hysteresis:	2-50%	

KPW174F & KPW174HF - KPW177F & KPW177HF

Reverse power relay (R1) is used to trip the generator breaker. The two individual settable overload relays (R2 and R3) can be used for non-essential load release or as start signal to standby generator etc.

R2 and R3 are non-latching and have a 10% fixed hysteresis.

Configuration: 3-Phase, 4-Wire (3W4)

Meter: Bi-Polar 1

	REVERSE POWER	OVER LOAD 1	OVER LOAD 2	Fail Safe	Latch	Fixed Hysteresis	Adjustable Hysteresis
R1	✓			✓	*✓		
R2		✓				✓	
R3			✓			✓	

Model	Latch	Output
KPW174F*	X	-
KPW174HF	-	-
KPW177F*	X	X
KPW177HF	-	X

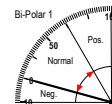

Adjustments	Trip level	Delay
Overload 1:	0-100% of FSD	0-30secs
Overload 2:	0-100% of FSD	0-30secs
Reverse Power:	0-20% of FSD	0-30secs
Hysteresis:	Fixed 10%	

KPW175A - KPW179A

The overload relay (R2) can be used for non-essential load release or as start signal to standby generator etc. A wide range adjustment for overload contact hysteresis can be set to enable R2 to be used for non-essential load to be reconnected or as standby generator stop signal.

Reverse overload relay (R1 & R3) is reverse over load protection when generator is running as motor. Reverse power relays can be used for generator trip, local indication, alarm system etc.

Configuration: 3-Phase, 4-Wire (3W4)

Meter: Bi-Polar 2

	REVERSE POWER	OVER LOAD	N/A	Fail Safe	Latch	Fixed Hysteresis	Adjustable Hysteresis
R1	✓			✓			
R2		✓					✓
R3	✓						

Model	Latch	Output
KPW175A	-	-
KPW179A	-	X

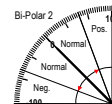

Adjustments	Trip level	Delay
Overload:	0-100% of FSD	0-30secs
Reverse Power:	0-100% of FSD	0-30secs
Hysteresis:	2-50%	

KPW175B - KPW179B

The overload relay (R2) can be used for non-essential load release or as start signal to standby generator etc. A wide range adjustment for overload contact hysteresis can be set to enable R2 to be used for non-essential load to be reconnected or as standby generator stop signal.

Reverse overload relay (R1 & R3 with different setting range) is reverse over load protection when generator is running as motor. Reverse power relays can be used for generator trip, local indication, alarm system etc.

Configuration: 3-Phase, 4-Wire (3W4)

Meter: Bi-Polar 2

	REVERSE POWER 1	REVERSE POWER 2	OVER LOAD	Fail Safe	Latch	Fixed Hysteresis	Adjustable Hysteresis
R1	✓			✓			
R2		✓				✓	
R3			✓			✓	

Model	Latch	Output
KPW175B	-	-
KPW179B	-	X

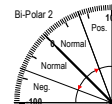

Adjustments	Trip level	Delay
Overload:	0-100% of FSD	0-30secs
Reverse Power 1:	0-20% of FSD	0-30secs
Reverse Power 2:	0-100% of FSD	0-30secs
Hysteresis:	Fixed 2%	

The MEGACON policy is one of continuous improvement, consequently equipment supplied may vary in detail from this publication.

Depending on application, select the model that matches the electrical installation. If none of the listed models fit your purpose please contact Megacon for customer adaptation.



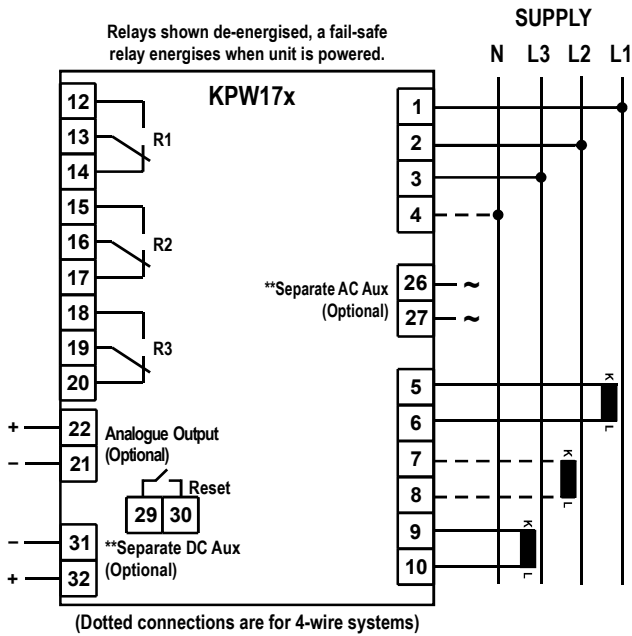

Analogue Output

KPW176A, KPW176H, KPW176F, KPW176HF, KPW178A, KPW178B, KPW177A, KPW177H, KPW177F, KPW177HF, KPW179A and KPW179B have an analogue output proportional to kW-meter reading. The signal is specifically intended as input to a control system for kW monitoring, load sharing, load shedding etc.

Add to type designation suffix from table below to designate output required:

O/P1	0-10mA	O/P6	-10-0-+10mA
O/P2	0-20mA	O/P7	-20-0-+20mA
O/P3	4-20mA	O/P8	0-10V
O/P4	4-12-20mA	O/P9	0,2-10V
O/P5	4-5,45-20mA	O/P10	4,3-20mA

Relay Reset

Any latched relay is reset by linking terminals 29 and 30 or by interrupting voltage input to terminal 1 (terminal 26 for models with separate aux. supply).

**Optional separate aux. supply:

Add nr 2 for models with separate aux. supply. (Example: KPW171C2)

To ensure correct kW measurement voltage phase sequence and CT, connections MUST be as shown on connection diagram.

Relay Configurations

The relay operation is delayed in the arrow direction, the reset is instantaneous. Both trip levels can, independently, individually set over the scale range (0-100% FSD).

The **Bi-Polar 1** version is available with 10% negative scale (standard version).

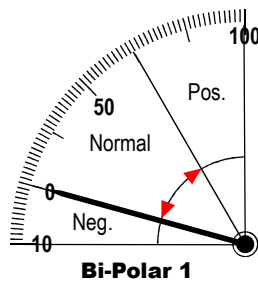

The **Bi-Polar 2** version is available with 100% negative scale (optional version).

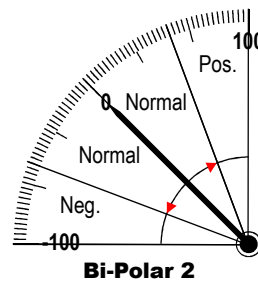

Dimensions

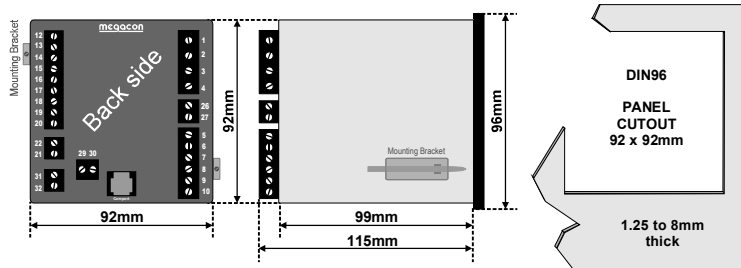

The MEGACON policy is one of continuous improvement, consequently equipment supplied may vary in detail from this publication.

ORDERING EXAMPLE:

Type:	KPW176A2
Aux. Supply:	200-240VAC
Monitored Voltage:	440VAC
Input Current:	1500/5A
Range:	-150/0/+1500kW
Analogue O/P:	4/5,45/20mA

